

NOTICE:

This device complies with Part 15 of the FCC Rules. Operation shall be subject to the following two conditions:

- (1) This device may not cause harmful interface, and
- (2) This device must accept any interface received, including interface that may cause undesirable operation.

This equipment has been tested and complied with the limits for a Class A digital device, pursuant to Part 15 of the FCC Rules. These limits are designed to provide a reasonable protection against harmful interference when the equipment is operated under a commercial environment. This equipment generates, uses, and can radiate radio frequency energy and, if not installed and used in accordance with the instruction manual, may cause harmful interference to radio communications. Operation of this equipment in a residential area is likely to cause harmful interference in which case the user will be required to correct the interference at his own expenses.

Note: *All brands and trademarks shall belong to their respective owner.*

Note: *Specification is subject to changes without notice.*

Using the ArgoxScan 8000

The ArgoxScan can automatically scan barcode at a distance.

Simply aim and pull the trigger. Code scanning is performed along the center of the light bar emitted from the reading window. This bar must cover the entire code.

Successful scanning shall be obtained by tilting the scanner with respect to the barcode to avoid direct reflections that impair the reading performance.

Recommended Steps

When the required settings have been configured, all settings are stored in non-volatile memory of scanner after reading EXIT Label. Recommended steps are as follows.

- 1) Host interface will be automatically detected. User does not need to set host interface for the scanner.
- 2) Set interface to optimize protocol of scanner with your host in interface section.
- 3) Set system control of scanner, such as specific adjustments double confirm, power saving, indicator and scanning mode which you prefer usage in system control section.
- 4) Set code options of scanner for your usage in code option section. You must make sure to enable the symbology first, then Min./Max. code length, code ID checksum and truncate digits are also converted.
- 5) Set string format of the scanner, such as preamble, postamble Prefix, suffix, code ID and code name transmission for your application in string format section.

Note: *If still not work properly. Please contact your dealer for further information.*

CONTENTS

Chapter 1 Introduction

Introduction.....	1
Default Setting.....	2
ArgoxScan8000 specification.....	3
Programming the ArgoxScan 8000 Series Scanner	6

Chapter 2 Parameter Setting

Interface.....	8
Interface Selection.....	8
Keyboard wedge.....	9
RS-232.....	14
Pin Assignments.....	17
System Control.....	18
Indication.	18
Transmission.....	20
Scan.....	24
String Setting.....	28
Code Option.....	32
UPCA.....	32
UPCE	36
EAN-13.....	40
EAN-8	44
Code 39	48
Interleaved 2 of 5	52
Industrial 2 of 5	54
Matrix 2 of 5 Eur	56
Codabar	58
Code-128	61
Code-93	65
Code-11.....	68
MSI/Plessey.....	70
UK/Plessey.....	72

Telepen.....	74
Standard 2 of 5	76
RSS-14.....	78
RSS-Limited.....	80
RSS-Expanded.....	82
China Post	84
Italian pharmacode	86
Appendix.....	88
Test Chart.....	88
ASCII Code Table	91
Parameter setting List.....	92

Introduction

Installation- Keyboard Wedge

- 1) First of all, you must switch off power for the terminal/computer.
- 2) Disconnect the keyboard cable from the back of the terminal/computer and connect to the interface cable of the scanner.
- 3) Connect the interface cable of the scanner to the terminal/computer.
- 4) Turn the terminal/computer power on.

RS-232

- 1) Disconnect power to the terminal/computer.
- 2) Connect the external power supply (DC adapter) to the interface cable of the scanner.
- 3) Plug the serial connector into the serial port on the back of your computer/terminal. Tighten the two screws to secure the connector to the port.
- 4) Plug the power pack into power source.
- 5) Once the scanner has been fully connected, turn the terminal/computer power back on.

USB (Simulate with keyboard wedge)

- 1) Connect the USB cable between to the terminal/computer.
- 2) Windows will automatically detect the USB device.

Note: *If any of the above operation is incorrect, turn off the power immediately and checking any improper connections. Go through all above steps again.*

Default setting

For each barcode shown as below:

V = Enabled as default setting

- = Not supported

Empty space = Not enabled at default setting

Code Type	Read Enable	Checksum Verification Enable	Checksum Transmission Enable	Code ID
UPC-A	V	V	V	A
UPC-E	V	V	V	E
EAN-13	V	V	V	F
EAN-8	V	V	V	FF
Code-39	V			*
Interleaved 2 of 5	V			I
Industrial 2 of 5		-	-	I
IATA				I
Matrix 2 of 5				B
Codabar				%
Code-128	V	V		#
Code-93		V two digits		&
Code-11		V One digit		O
MSI/Plessey		V		@
UK/Plessey		V		@
Telepen				S
Standard 2 of 5				I
GS1 DataBar Omnidirectional		-	-	R4
GS1 DataBar Limited		-	-	RL
GS1 DataBar Expanded		-	-	RX
China Post Italian		-	-	t
Pharmacode.		-	-	p

AS-8000 Specification

ArgoScan 8000 series	
Specification	Model AS-8000 series
Operational	
Light Source	660 nm Visible Red LED
Optical System	2048 pixel CCD (Charge-coupled device)
Depth of Scan Field	0-180 mm (CODE 39, 500Lux, PCS=90%, 20mils)
Scanning Width	50 mm wide @ 10mm
Scan Speed	100 scans/sec
Resolution	0.1mm (4mils) Code39,PCS=90%
Print Contrast	45% or more
Scanning Angle	Pitch: 60° Yaw: 70°
Decode Capability	Auto-discriminates all standard one dimension barcodes
Beeper Operation	7 tones or no beep
Indicator	Green led and beep sound
Mechanical	
Length	176 mm
Width-handle	40 mm
Width-head	67 mm
Depth-handle	30 mm
Depth-head	40 mm
Weight	90 g (cable not included)
Cable – K/B wedge	Straight 2.0 m

Connector type	Crimp type female connector
Case material	ABS plastic
Cushion material	TPR
Electrical	
Input Voltage	5 VDC \pm 0.25V
Power - Operating	Max. 750 mW
Power - Standby	150 mW
Current - Operating	Max. 150 mA @ 5 VDC
Current - Standby	30 mA @ 5 VDC
DC Transformers	Class 2; 5VDC @ 450 mA
Agency listing	FCC Class A, CE
Environmental	
Operating Temperature	0°C to 45°C (32°F to 113°F)
Storage	-20°C to 60°C (-4°F to 140°F)
Humidity	10% to 90% relative humidity, non-condensing
Light Level	Up to 20000 Lux
Shock	1.5m drop onto concrete
Contaminants	Seals to resist airborne particulate contaminants
Ventilation	None required

Programming	
Programming method	Manual (Reading special barcode), DOS command through RS-232 (RS-232 model)
Programmable characteristics	Code type selection, check digit selection, Decoding option Transmitted character delay, Header selection, trailer selection, message suffix, good read beep tone and volume, scanner trigger selection Keyboard emulation type (intermessage delay, keyboard type and keyboard language) Serial interface type (ACK/NAK, Xon/Xoff, RTS/CTS, good read LED control, start/stop bits)

Programming the ArgoScan 8000 Series Scanner

To program the 8000 series scanner, you must scan a series of programming barcode in the correct order. Fold out the back cover of this manual. You will see a table of alphanumeric barcodes, which are used to program the various options presented.

To program each option, you must:

1. Scan the **Program** barcode on the parameter setting part.
2. Enter the option mode by scanning the **Option Bar Code** (also on the Parameter setting part).
3. To the right of the option barcode, the necessary alphanumeric inputs are listed. Scan these alphanumeric entries from the **back fold out** page. To confirm above steps, you must scan the **Finish** barcode on the back fold out page.
4. Once you have finished programming. Scan the **Exit** barcode, listed on the lower right hand corner of each parameter setting part.



Program

Program Barcode

Option Bar Code	Option	Alphanumeric Entry
 *7AA*	Good-read off	00
Scanning mode	Momentary	01 *
	Alternate	02
	Timeout off	03
	Continue	04
	Test only	05

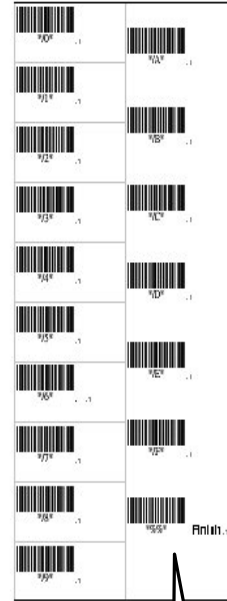

Exit

Option Barcode

Exit Barcode

Back Fold Out

Finish barcode

Interface Selection

This decoder built-in scanner comes in three models and supports interfaces such as keyboard wedge, RS232 serial, and the latest USB interface. You will need to select an appropriate model for a specific interface.

Interface selection: The factory interface default can not be changed for other type interface. One specific model only supports the appropriate host interface.

For the appropriate model number of AS-8000 to various PC computer/terminal and packaging, please consult your local vendor or Argox sales team at info@argox.com

Keyboard wedge

As a keyboard interface, the scanner supports most of the popular PCs and IBM terminals. The installation of the wedge is a fairly simple process without any changes of software or hardware.

Keyboard Type: AS-8000 keyboard wedge model only supports keyboard interface with PS/2 type connector.



\$%+PRO

Program

<i>Option Bar Code</i>	<i>Option</i>	<i>Alphanumeric Entry</i>
 *2AA* Keyboard type	IBM PS/2 Reserved Reserved Reserved Reserved Reserved Reserved	00 * 01 02 03 04 05 06



%\$\$

Exit

Keyboard wedge

Keyboard Layout: The selecting of keyboard layout supports many country languages other than USA keyboard layout. First you need to confirm country language that you desire. In DOS, using command “keyb” to select the desirable keyboard layout or in WINDOWS entry “Control” then pops “Keyboard” to select country at “language” item. For details, please refer to your DOS or WINDOWS user’s manual.

Keyboard Speed: By selecting, you can change output speed of scanner to match with host computer. Generally, set 00 or 01 in working high speed. If some output characters of barcode have been lost, you may need to set 05 or 06 to match your host keyboard speed.

Function Key: Set Enable, scanner can output code as pressing function-key in your application program while the barcode datas contain ASCII value between 01₁₆ to 1F₁₆. Refer to ASCII table.





Numeric Key: The Keypad has to be selected if your application program is only keypad numeric code acceptable. So, scanner will output code as press numeric keypad when it read numeric digit. (The keypad is in the right side of keyboard, and Num Lock control key is also on.) If Alt+Keypad is selected, Caps Lock and output will be independent.



\$%+PRO

Program

<i>Option Bar Code</i>	<i>Option</i>	<i>Alphanumeric Entry</i>
-------------------------------	----------------------	----------------------------------

 *2AB* Keyboard layout	USA Belgium Danish France Germany Italian Portuguese Spanish Swedish Switzerland UK Latin American Japanese	00 * 01 02 03 04 05 06 07 08 09 10 11 12
 *2AC* Keyboard speed	0-8 0 : high clock rate 8 : low clock rate	00-08 03 *
 *2AD* Function key	Disable Enable	00 01 *
 *2AE* Numeric key	Alphabetic key Numeric keypad (Num lock state only) Alt+Keypad	00 * 01 02



Keyboard wedge

Caps Lock: By selecting Caps lock"ON" or Caps lock"OFF", scanner can get Caps Lock status.

Power-on simulation: All of the PCs check the keyboard status during power-on selftest. It is recommended to Enable function if you are working without keyboard installation. It simulates keyboard timing and pass keyboard present status to the PC during power-on.





Inter-character delay: This delay is inserted after each data characters transmitted. If the transmission speed is too high, the system may not be able to receive all characters. Adjust it and try out suited delay to make system work properly.

Block transmission delay: It is a delay timer between barcode data output. The feature is used to transfer continually with shorter barcode data or multi-field scanning.



\$%+PRO

Program

<i>Option Bar Code</i>	<i>Option</i>	<i>Alphanumeric Entry</i>
 *2AF* Caps lock	Caps lock"ON" Caps lock"OFF"	00 01 *
 *2AG* Power-on simulation	Disable Enable	00 * 01
 *2AH* Inter-character delay	00-99 msec	00-99 02 *
 *2AI* Block transmission delay	00-99 10 msec	00-99 10 *



%\$\$

Exit

RS-232

CTS: Clear To Send (Hardware Signal)

RTS: Request To Send (Hardware Signal)

Xon: Transmit On (ASCII Code 11 16)

Xoff: Transmit Off (ASCII Code 13 16)

Flow control:

None-The communication only uses TxD and RxD signals without regard for any hardware or software handshaking protocol.

RTS/CTS-If the scanner wants to send the barcode data to host computer, it will issue the RTS signal first, wait for the CTS signal from the host computer, and then perform the normal data communication. If there is no replied CTS signal from the host computer after the timeout (Response Delay) duration, the scanner will issue a 5 warning beeps.

Xon/Xoff- When the host computer is unable to accept data, it sends a Xoff code to inform the scanner to suspend data transmission, and Xon to continue.

ACK/NAK- When the ACK/NAK protocol is used, the scanner waits for an ACK (acknowledge) or (not acknowledge) from the host computer after data transmission, and will resend in response to a NAK.

Inter-character delay: It is delay time between data character's data output. It is also same as Inter-char. delay of keyboard wedge.





Block transmission delay: It is a delay time between barcode data output. It is also same as Block transmission delay of keyboard wedge.

Response delay: This delay is used for serial communication of the scanner to waiting for handshaking acknowledgment from the host computer.



\$%+PRO

Program

<i>Option Bar Code</i>	<i>Option</i>	<i>Alphanumeric Entry</i>
 *3AA* Flow control	None RTS/CTS Xon/Xoff ACK/NAK	00 * 01 02 03
 *3AB* Inter-character delay	00-99 (msec)	00-99 00 *
 *3AC* Block transmission delay	00-99 (10 msec)	00-99 00 *
 *3AD* Response delay	00-99 (100 msec)	00-99 20 *







%\$\$

Exit



\$%+PRO

Program

<i>Option Bar Code</i>	<i>Option</i>	<i>Alphanumeric Entry</i>
 *3AE* Baud rate	300 BPS 600 BPS 1200 BPS 2400 BPS 4800 BPS 9600 BPS 19200 BPS 38400 BPS	00 01 02 03 04 05 * 06 07
 *3AF* Parity	None Odd Even	00 * 01 02
 *3AG* Data bit	8 bits 7 bits	00 * 01
 *3AH* Stop bit	One bit Two bits	00 * 01



%\$\$

Exit

Pin Assignments

Keyboard Wedge Connector (To Host Side):

Pin	Mini-DIN 6P Male	Mini-DIN 6P Female
1	DATA / PC	CLK / KB
2	NC	GND
3	GND	DATA / KB
4	VCC (+5V)	VCC (+5V)
5	CLK / PC	NC
6	NC	NA

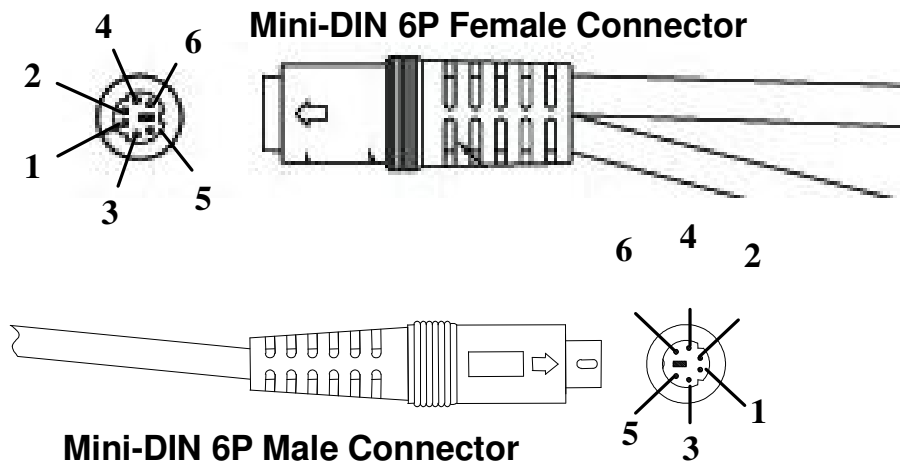

RS-232 DB-9F Connector (To Host Side):

Pin	Definition
1	NC
2	TXD
3	RXD
4	NC
5	GND
6	NC
7	CTS
8	RTS
9	VCC (+5V)

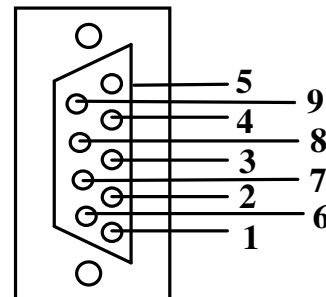

Indication

Power on alert: After power-on the scanner it will generate an alert signal to indicate a successful self-test.

LED indication: After each successful reading, the LED above the scanner will light up to indicate a good barcode reading.

Beeper indication: After each successful reading, the scanner will beep buzzer to indicate a good barcode reading, and its **Beep loudness**, **Beep tone freq.** and **Beep tone duration** are adjustable.







Beep loudness/Beep tone freq./Beep tone duration: You can adjust **Beep Loudness**, **Beep tone** and **Beep duration** for a good reading upon favorite usage.

<note > In Beep tone frequency setting, 00~10 are used to set to Melody 0~10 and not for tone frequency 0~1000 Hz. The other values from 11~99 are defined as the beep tone frequency.



\$%+PRO

Program

<i>Option Bar Code</i>	<i>Option</i>	<i>Alphanumeric Entry</i>
 *5AA* Power on alert	Disable Enable	00 01 *
 *5AB* LED indication	Disable Enable	00 01 *
 *5AC* Beeper indication	Disable Enable	00 01 *
 *5AD* Beep loudness	00-07	00-07 07 *
 *5AE* Beep tone freq.	00-99 (100Hz)	00-99 27 *
 *5AF* Beep tone duration	00-99 (10 msec)	00-99 10 *



%\$\$

Exit

Transmission

Preamble transmission: By setting **Enable**, Preamble will be appended before the data transmitted.

Postamble transmission: By setting **Enable**, Postamble will be appended after the data is transmitted.

Insert data group 1-4 position: The scanner offers 4 positions to insert among the symbol. The position default value is "00" to indicate no character insertion. Beside, make sure insertion positions are not greater than the symbols; otherwise the insertion data is not effective.





Code ID position: Upon your usage, the transmitting position of Code ID can be selected to place **Before Code Data** or **After Code Data** when it is transmitted.



\$%+PRO

Program

Option Bar Code	Option	Alphanumeric Entry
<p>*6AA*</p> <p>Preamble transmission</p>	<p>Disable</p> <p>Enable</p>	<p>00 *</p> <p>01</p>
<p>*6AB*</p> <p>Postamble transmission</p>	<p>Disable</p> <p>Enable</p>	<p>00 *</p> <p>01</p>

 *6AC* Insert data group 1 position	00-63 (00: no insertion)	00-63 00 *
 *6AD* Insert data group 2 position	00-63 (00: no insertion)	00-63 00 *
 *6AE* Insert data group 3 position	00-63 (00: no insertion)	00-63 00 *
 *6AF* Insert data group 4 position	00-63 (00: no insertion)	00-63 00 *
 *6AG* Code ID position	Before code data After code data	00 * 01



Exit

Transmission

Code ID transmission: If your application is needed to transmit Code ID, you must set this to Proprietary ID or AIM ID.

Code length transmission: A number of data digits can be transmitted before the code data when **Enable** is selected. The total length of the barcode is the number of barcode data except Truncate Leading/Ending Digits. And the length is a number with two digits.



Code name transmission: This function is to show unknown barcode symbologies that include all readable symbologies of the scanner. When Enable is selected, Code Name will be transmitted before code data, you will know what kind of barcode symbology is.

Case conversion: Under the barcode, you can set the alphabet in either upper case or lower case.



Program

Option Bar Code	Option	Alphanumeric Entry
<p><code>*6AH*</code></p> <p>Code ID transmission</p>	<p>Disable</p> <p>Proprietary ID</p> <p>AIM ID</p>	<p>00 *</p> <p>01</p> <p>02</p>

 *6AI* Code length transmission	Disable Enable	00 * 01
 *6AJ* Code name transmission	Disable Enable	00 * 01
 *6AK* Case conversion	Disable Upper case Lower case *For barcode data only	00 * 01 02



Exit

Format of barcode data transmission:

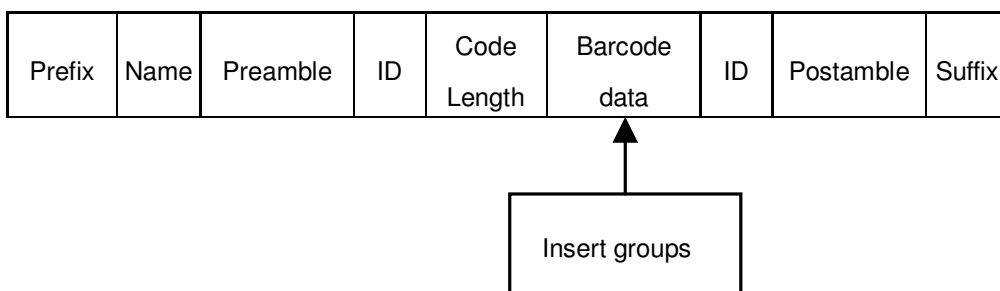

Scan

Scanning mode:

Good-read off-The trigger button must be pressed to activate scanning. The light source of scanner stops scanning when there is a successful reading or no code is decoded after the Stand-by duration elapsed.

Momentary-The trigger button acts as a switch. Press button to activate scanning and release button to stop scanning.

Alternate-The trigger button acts as a toggle switch. Press button to activate or stop scanning.

Timeout off-The trigger button must be pressed to activate scanning, and scanner stops scanning when no code is decoded after the Stand-by duration elapsed.

Continue-The scanner always keeps reading, and it does not matter when trigger button is pressed or duration is elapsed.

Double read timeout: If the barcode has been scanned twice, then only the first barcode will be accepted.





Double confirm: If it is enabled, the scanner will require a several times successful decoding to confirm the barcode data. The more confirming times required the more inhibitive miss-reading code will be shown. If you set Double confirm, the Multi field scan Enable function won't be able to work.

Supplement Check Counter: It will be more reliable to read the barcode with extension (supplement) like UPCE/A or EAN-8/13, but slow down the decoding speed when this counter is set more.



Program

<i>Option Bar Code</i>	<i>Option</i>	<i>Alphanumeric Entry</i>
-------------------------------	----------------------	--------------------------------------

 *7AA* Scanning mode	Good-read off Momentary Alternate Timeout off Continue Test only	00 01 * 02 03 04 05
 *7AB* Stand-by duration	01-99 (second)	01-99 06 *
 *7AC* Double read timeout	01-99 (10 msec)	01-99 50 *
 *7AD* Double confirm	00-99 (00: no double confirm)	00-09 00 *
 *7AE* Supplement Check Counter	00-40	00-40 20 *



Exit

Scan

Global min./max. code length: Global Minimum and Maximum length can be set to qualify data entry. The length is defined as the actual barcode data length to be sent. Label with length exceeds these limits will be rejected. Make sure that the Minimum length setting is no greater than the Maximum length setting, or otherwise the labels of the symbology will not be readable. In particular, you can set the same value for both Minimum and Maximum reading length to force the fixed length barcode decoded. The values of setting have no effect on certain symbologies with fixed length.

Notes 1): Please set the min/max length if you have special demand for individual barcode.

2): Include the Check sum digits if you want to set Global min/max code length.

Inverted image scan: Set Enabled the scanner will scan both black/white barcode with white/black background.





CTS trigger: This operation enabled an external device to control scanning. The CTS trigger is controlled by apply an external trigger signal to the CTS input. When active, this signal causes scanning to begin as the scanner's trigger was depressed.

Position indication: This function can indicate the specific location before scanning. You can also set up the time of indication.



\$%+PRO

Program

<i>Option Bar Code</i>	<i>Option</i>	<i>Alphanumeric Entry</i>
 *7AF* Global min. code length	00-64	00-64 04 *
 *7AG* Global max. code length	00-64	00-64 63 *
 *7AH* Inverted image scan	Disable Enable	00 * 01
 *7AI* CTS trigger	Disable Enable	00 * 01
 *7AL* Stand mode selection	LED "on" LED "off"	00 * 01



%\$\$

Exit

String Setting

Prefix characters: Up to 22 ASCII characters may be sent before data digits.



Prefix	Data Digits	Suffix
--------	-------------	--------

Suffix characters: Up to 22 ASCII characters may be sent after data digits.



\$%+PRO

Program

Option Bar Code	Option	Alphanumeric Entry
 *8AA* Prefix characters setting	None 1-22 characters	00 * 00-ffH ASCII code
 *8AB* Suffix characters setting	None 1-22 characters	0D * 00-ffH ASCII code



%\$\$

Exit

String Setting

Preamble/ Postamble characters: They are appended to the data automatically when each barcode is decoded.

Example:

Add a prefix/suffix or preamble/postamble for all symbologies. In this example, you are sending a \$ symbol as a prefix for all symbologies.

Steps:

- 1) Scan **Programming** and **Prefix characters setting** barcode.
- 2) Use the ASCII code table to find the value of \$→24.
- 3) Scan **2** and **4** from the barcode on the fold out back page.
- 4) Scan **Finish** from the barcode on the fold out page.
- 5) Scan **Exit** barcode.

Insert G1/G2/G3/G4 character setting: The scanner offer 4 positions and 4 characters to insert among the symbol.

Example: Barcode “1 2 3 4 5 6”.

Output- Barcode “1 2 A B 3 4 C D 5 6”.







Steps:

- 1) Scan **Programming** and **Insert G1 characters setting** barcode.
- 2) Use the ASCII code table to find the value of A→41,B→ 42.
- 3) Scan **4, 1** and **4, 2** from the barcode on the fold out back page.
- 4) Scan **Finish** from the barcode on the fold out page.
- 5) Repeat the same procedure in **Insert G2 characters setting**.
- 6) Scan **Exit** barcode.
- 7) Insert data group 1-4 position. Please refer to Chapter-Transmission, page 65 and in specific barcode that you want to use.



\$%+PRO

Program

Option Bar Code	Option	Alphanumeric Entry
 *8AC* Preamble characters	None 1-22 characters	'PREAMBLE' * 00-ffH ASCII code
 *8AD* Postamble characters	None 1-22 characters	'POSTAMBLE' * 00-ffH ASCII code
 *8AE* Insert G1 characters	None 1-22 characters	'GROUP1' * 00-ffH ASCII code
 *8AF* Insert G2 characters	None 1-22 characters	'GROUP2' * 00-ffH ASCII code
 *8AG* Insert G3 characters	None 1-22 characters	'GROUP3' * 00-ffH ASCII code
 *8AH* Insert G4 characters	None 1-22 characters	'GROUP4' * 00-ffH ASCII code



%\$\$

Exit

UPCA

Read: Format

Leading Zero	Data Digits (11 Digits)	Check Digit
-----------------	----------------------------	----------------

Check-sum transmission: By setting **Enable**, checks sum will be transmitted.

Truncate leading/ending: The leading or ending digits of barcode data characters can be truncated when these values are set to non-zero. It will beep instead of reading anything when the truncate value is more than the barcode data digits or the value of Truncate Leading is overlapped with that of the Ending. The maximum value of truncate digits is 15.

Code ID setting: **Code ID setting** is a character used to represent the symbol upon a succeeding reading. A **Code ID setting** is prefixed to the data begin or end transmitted if the feature is selected. If you want application to transmit Code ID, you must set Code ID transmission to **Enable** first. Refer to Code ID transmission.

Insertion group selection: The scanner offer one or two insertion group for own symbology. By setting one or two digits to indicate which insertion group you want to insert. You may refer to Character insertion.

Example: Group 2 → set 02 or 20.





Group 1 and 4 → set 14 or 41.



\$%+PRO

Program

<i>Option Bar Code</i>	<i>Option</i>	<i>Alphanumeric Entry</i>
<p>*NAA*</p>	Disable	00
Read	Enable	01 *

 *NAC* Check-sum transmission	Disable Enable	00 01 *
 *NAF* Truncate leading	0-15	00-15 00 *
 *NAG* Truncate ending	0-15	00-15 00 *
 *NAH* Code ID setting	00-ffH ASCII code	00-ffH < A > *
 *NAI* Insert group selection	00-44	00-44 00 *



Exit

UPCA

Supplement digits: The Supplement digits barcode is the supplemental 2 or 5 characters for WPC code.

Format

Leading Zero	Data Digits (11 Digits)	Check Digit	Supplement Digits 2 or 5 or UCC / EAN 128
-----------------	----------------------------	----------------	---

Truncation / Expansion: The leading “0” digits of UPCA data characters can be truncated when enabled.



Supplement Check Counter: It will be more reliable to read the barcode with extension (supplement) like UPCE/A or EAN-8/13, but slow down the decoding speed when this counter is set more.



\$%+PRO

Program

<i>Option Bar Code</i>	<i>Option</i>	<i>Alphanumeric Entry</i>
 *NAJ* Supplement digits	None	00 *
	2 digits	01
	5 digits	02
	2,5 digits	03
	UCC/EAN 128	04
	2, UCC/EAN 128	05
	5, UCC/EAN 128	06
	All	07

 *NAK* Truncation/ Expansion	None Truncate leading zero Expand to EAN13	00 01 * 02
 *7AE* Supplement Check Counter		20 *



Exit

UPCE

Read: Format

Leading Zero	Data Digits (6 Digits)	Check Digits
-----------------	---------------------------	-----------------

Check-sum verification: The checksum of EAN-13 is optional and made as the sum of the numerical value of the data digits.

Check-sum transmission: By setting Enable, checks sum will be transmitted.

Truncate leading/ending: Refer to Truncate leading/ending of UPCA.



Code Id setting: Refer to Code ID setting of UPCA.



\$%+PRO

Program

<i>Option Bar Code</i>	<i>Option</i>	<i>Alphanumeric Entry</i>
 OAA Read	Disable Enable	00 01 *
 OAC Check-sum transmission	Disable Enable	00 01 *

 *OAF* Truncate leading	0-15	00-15 00 *
 *OAG* Truncate ending	0-15	00-15 00 *
 *OAH* Code ID setting	00-ffH ASCII code	00-ffH < E > *



Exit

UPCE

Insertion group selection: Refer to Insertion group selection of UPCA.

Supplement digits:

Format

Leading Zero	Data Digits (6 Digits)	Check Digit	Supplement Digits 2 or 5 or UCC/EAN 128
-----------------	---------------------------	----------------	---

Expansion: The expansion function is used only for UPCE and EAN-8 code reading. It extends to 13-digits with “0” digits when the feature is enabled.

Example: Barcode “0123654”

Output: “0012360000057”





UPCE-1: To enable scanner to read UPCE with leading digit

Supplement Check Counter: It will be more reliable to read the barcode with extension (supplement) like UPCE/A or EAN-8/13, but slow down the decoding speed when this counter is set more.



Program

<i>Option Bar Code</i>	<i>Option</i>	<i>Alphanumeric Entry</i>
 *OAI* Insert group selection	00-44	00-44 00 *

 Supplement digits	None 2 digits 5 digits 2,5 digits UCC/EAN 128 2, UCC/EAN 128 5, UCC/EAN 128 All	00 * 01 02 03 04 05 06 07
 Truncation/Expansion	None Truncate leading zero Expand to EAN13 Expand to UPCA	00 * 01 02 03
 Expansion	Disable Enable	00 * 01
 UPCE-1	Disable Enable	00 * 01
 Supplement Check Counter		20 *



Exit

EAN-13

Read: Format

Data Digits (12 Digits)	Check Digits
-------------------------	--------------

Check-sum verification: The checksum of EAN-13 is optional and made as the sum of the numerical value of the data digits.

Check-sum transmission: By setting Enable, checks sum will be transmitted.

Truncate leading/ending: Refer to Truncate leading/ending of UPCA.



Program

<i>Option Bar Code</i>	<i>Option</i>	<i>Alphanumeric Entry</i>
 Read	Disable Enable	00 01 *
 Check-sum transmission	Disable Enable	00 01 *
 Truncate leading	0-15	00-15 00 *

 *GAG* Truncate ending	0-15	00-15 00 *
---	------	-------------------



Exit

EAN-13

Code Id setting: Refer to Code ID setting of UPCA.

Insertion group selection: Refer to Insertion group selection of UPCA.

Supplement digits:

Format

Data Digits (12 Digits)	Check Digits	Supplement Digits 2 or 5 or UCC / EAN 128
----------------------------	-----------------	---

ISBN/ISSN: The ISBN (International Standard Book Number) and ISSN (International Standard Serial Number) are two kinds of barcode for book and magazines. The ISBN is 10 digits with leading “978” and the ISSN is 8 digits with leading “977” of the “EAN-13” symbology.

Example: Barcode “9789572222720” - Output: “9572222724”

Example: Barcode “9771019248004” - Output: “10192484”





Supplement Check Counter: It will be more reliable to read the barcode with extension (supplement) like UPCE/A or EAN-8/13, but slow down the decoding speed when this counter is set more.



\$%+PRO

Program

<i>Option Bar Code</i>	<i>Option</i>	<i>Alphanumeric Entry</i>
------------------------	---------------	-------------------------------

 *GAH* Code ID setting	00-ffH ASCII code	00-ffH < F > *
 *GAI* Insert group selection	00-44	00-44 00 *
 *GAJ* Supplement digits	None 2 digits 5 digits 2,5 digits UCC/EAN 128 2, UCC/EAN 128 5, UCC/EAN 128 All	00 * 01 02 03 04 05 06 07
 *GAL* ISBN/ISSN conversion	Disable Enable	00 * 01
 *7AE* Supplement Check Counter		20 *

Exit

EAN-8

Read: Format

Data Digits (7 Digits)	Check Digits
---------------------------	-----------------

Check-sum verification: The checksum of EAN-8 is optional and made as the sum of the numerical value of the data digits.

Check-sum transmission: By setting Enable, checks sum will be transmitted.

Truncate leading/ending: Refer to Truncate leading/ending of UPCA.



Code Id setting: Refer to Code ID setting of UPCA.





Insertion group selection: Refer to Insertion group selection of UPCA.



\$%+PRO

Program

<i>Option Bar Code</i>	<i>Option</i>	<i>Alphanumeric Entry</i>
 *FAA* Read	Disable Enable	00 01 *
 *FAC* Check-sum transmission	Disable Enable	00 01 *

 Truncate leading	0-15	00-15 00 *
 Truncate ending	0-15	00-15 00 *
 Code ID setting	Two characters 00-ffH ASCII code	00-ffH, 00-ffH < FF > *
 Insert group selection	00-44	00-44 00 *



Exit

EAN-8

Supplement digits: Format

Data Digits (7 Digits)	Check Digits	Supplement Digits 2 or 5 or UCC/EAN 128
---------------------------	-----------------	---

Truncation / Expansion: Refer to Truncate Leading zero of UPCE.



Expansion: Refer to Expansion of UPCE.

Supplement Check Counter: It will be more reliable to read the barcode with extension (supplement) like UPCE/A or EAN-8/13, but slow down the decoding speed when this counter is set more.



\$%+PRO

Program

<i>Option Bar Code</i>	<i>Option</i>	<i>Alphanumeric Entry</i>
 *FAJ* Supplement digits	None 2 digits 5 digits 2,5 digits UCC/EAN 128 2, UCC/EAN 128 5, UCC/EAN 128 All	00 * 01 02 03 04 05 06 07
 *7AE*	Counter	20 *

 *FAK* Truncation / Expansion	Disable Enable	00 * 01
 *FAK* Truncation / Expansion	None Truncate leading zero Expand to EAN13	00 * 01 02
 *FAL* Expansion	Disable Enable	00 * 01



Exit

Code 39

Read: Format

Start “★”	Data Digits (Variable)	Checksum (Optional)	End “★”
--------------	----------------------------	------------------------	------------

Check-sum verification: The checksum of Code-39 is optional and made as the sum module 43 of the numerical value of the data digits.

Check-sum transmission: By setting Enable, checksum will be transmitted.

Max./Min. code length: Each symbology has own Max./Min. Code Length. They can be set to qualify data entry. If their Max./Min. Code Length is zero, the Global Min./Max. Code Length is in effect. The length is defined as to the actual barcode data length to be sent. Label with length exceeds these limits will be rejected. Make sure that the Minimum length setting is no greater than the Maximum length setting, or otherwise all the labels of the symbology will not be readable. In particular, you can see the same value for both Minimum and Maximum reading length to force the fixed length barcode decoded.

Truncate leading/ending: Refer to Truncate leading/ending of UPCA.







Code Id setting: Refer to Code ID setting of UPCA.



\$%+PRO

Program

<i>Option Bar Code</i>	<i>Option</i>	<i>Alphanumeric Entry</i>
 BAA	Disable	00
Read	Enable	01 *

 *BAB* Check-sum verification	Disable Enable	00 * 01
 *BAC* Check-sum transmission	Disable Enable	00 * 01
 *BAD* Max. code length	00-64	00-64 00 *
 *BAE* Min. code length	00-64	00-64 01 *
 *BAF* Truncate leading	0-20	00-20 00 *
 *BAG* Truncate ending	0-15	00-15 00 *
 *BAH* Code ID setting	00-ffH ASCII code	00-ffH < * >



Exit

Code 39

Insertion group selection: Refer to Insertion group selection of UPCA.

Format: The Full ASCII Code-39 is an enhanced set of Code-39 that is the data with total of 128 characters to represent Full ASCII code. It is combined one of the digits +, %, \$ and/ with one of the alpha digits (A to Z).

Append: This function allows several symbols to be concatenates and be treat as one single data entry. The scanner will not transmit the embedded appending code (space for Code-39). If Enable and other symbols were read again with the appended code, then codes will be transmitted without Code ID, Preamble and Prefix. When a symbol was decoded without the appended code, the data will be transmitted without Code ID and Prefix, but the Postamble Suffix codes are appended. This function is used when the first number of code 39 is a space. Example: □123456.

Start/end transmission: The start and end characters of Code-39 are“★”. You can transmit all data digits including two “★”.



\$%+PRO

Program

<i>Option Bar Code</i>	<i>Option</i>	<i>Alphanumeric Entry</i>
 *BAI* Insert group selection	00-44	00-44 00 *

 *BAJ* Format	Standard Full ASCII	00 * 01
 *BAK* Append	Disable Enable	00 * 01
 *BAM* Start/end transmission	Disable Enable	00 * 01



Exit

Interleaved 2 of 5

Read: Format

Data Digits (Variable)	Checksum (Optional)
---------------------------	------------------------

Check-sum verification: The checksum is made as the sum module 10 of the numerical values of all data digits.

Check-sum transmission: By setting Enable, checksum will be transmitted.

Max./Min. code length: Refer to Max./Min. code length of Code-39.

Truncate leading/ending: Refer to Truncate leading/ending of UPCA.



Code Id setting: Refer to Code ID setting of UPCA.

Insertion group selection: Refer to Insertion group selection of UPCA.



\$%+PRO

Program

<i>Option Bar Code</i>	<i>Option</i>	<i>Alphanumeric Entry</i>
 *IAA* Read	Disable Enable	00 01 *
 *IAB* Check-sum verification	Disable Enable	00 * 01

 *IAC* Check-sum transmission	Disable Enable	00 * 01
 *IAD* Max. code leading	00-64	00-64 00 *
 *IAE* Min. code leading	00-64	00-64 00 *
 *IAF* Truncate leading	0-15	00-15 00 *
 *IAG* Truncate ending	0-15	00-15 00 *
 *IAH* Code ID setting	00-ffH ASCII code	00-ffH < i > *
 *IAI* Insert group selection	00-44	00-44 00 *



Exit

Industrial 2 of 5

Read: Format

Data Digits (Variable)	Checksum (Optional)
---------------------------	------------------------

Max./Min. code length: Refer to Max./Min. code length of Code-39.

Truncate leading/ending: Refer to Truncate leading/ending of UPCA.

Code Id setting: Refer to Code ID setting of UPCA.





Insertion group selection: Refer to Insertion group selection of UPCA.



\$%+PRO

Program

<i>Option Bar Code</i>	<i>Option</i>	<i>Alphanumeric Entry</i>
<p>*HAA*</p> <p>Read</p>	<p>Disable</p> <p>Enable</p>	<p>00 *</p> <p>01</p>
<p>*HAD*</p> <p>Max. code length</p>	<p>00-64</p>	<p>00-64</p> <p>00 *</p>
<p>*HAE*</p> <p>Min. code length</p>	<p>00-64</p>	<p>00-64</p> <p>00 *</p>

 *HAF* Truncate leading	0-15	00-15 00 *
 *HAG* Truncate ending	0-15	00-15 00 *
 *HAH* Code ID setting	00-ffH ASCII code	00-ffH < i > *
 *HAI* Insert group selection	00-44	00-44 00 *



Exit

Matrix 2 of 5 Eur

Read: Format

Data Digits (Variable)	Checksum (Optional)
---------------------------	------------------------

Checksum Verification: The checksum is made as the sum module 10 of the numerical values of all data digits.

Checksum Transmission: By setting Enable, checksum will be transmitted.

Max./Min. code length: Refer to Max./Min. code length of Code-39.

Truncate leading/ending: Refer to Truncate leading/ending of UPCA.



Code Id setting: Refer to Code ID setting of UPCA.







Insertion group selection: Refer to Insertion group selection of UPCA.



\$%+PRO

Program

Option Bar Code	Option	Alphanumeric Entry
 *PAA* Read	Disable Enable	00 * 01
 *PAB* Checksum Verification	Disable Enable	00 * 01

 *PAC* Checksum Transmission	Disable Enable	00 * 01
 *PAD* Max. code length	00-64	00-64 00 *
 *PAE* Min. code length	00-64	00-64 00 *
 *PAF* Truncate leading	0-15	00-15 00 *
 *PAG* Truncate ending	0-15	00-15 00 *
 *PAH* Code ID setting	00-ffH ASCII code	00-ffH < B > *
 *PAI* Insert group selection	00-44	00- 44 00 *



Exit

Codabar

Read: Format

Start	Data Digits (Variable)	Checksum (Optional)	End
-------	------------------------	---------------------	-----

Checksum Verification: The checksum is made as the sum module 16 of the numerical values of all data digits.

Checksum Transmission: By setting Enable, checksum will be transmitted.



Max./Min. code length: Refer to Max./Min. code length of Code-39.







Truncate leading/ending: Refer to Truncate leading/ending of UPCA.

Code Id setting: Refer to Code ID setting of UPCA.



Program

Option Bar Code	Option	Alphanumeric Entry
 *EAA* Read	Disable Enable	00 * 01
 *EAB* Checksum Verification	Disable Enable	00 * 01

 *EAC* Checksum Transmission	Disable Enable	00 * 01
 *EAD* Max. code length	00-64	00-64 00 *
 *EAE* Min. code length	00-64	00-64 00 *
 *EAF* Truncate leading	0-15	00-15 00 *
 *EAG* Truncate ending	0-15	00-15 00 *
 *EAH* Code ID setting	00-ffH ASCII code	00-ffH < % > *



Exit

Codabar

Insertion group selection: Refer to Insertion group selection of UPCA.

Start/End type: The Codabar has four pairs of Start/End pattern; you may select one pair to match your application.

Start/End Transmission: Refer to Start/End Transmission of Code 39.



\$%+PRO

Program

Option Bar Code	Option	Alphanumeric Entry
 *EAI* Insert group selection	00-44	00-44 00 *
 *EAJ* Start/End type	ABCD/ABCD abcd/abcd ABCD/TN*E abcd/tn*e	00 * 01 02 03
 *EAK* Start/End transmission	Disable Enable	00 * 01



%\$\$

Exit

Code-128

Read: Format

Data Digits (Variable)	Checksum (Optional)
---------------------------	------------------------

Checksum Verification: The checksum is made as the sum module 103 of all data digits.

Checksum Transmission: By setting **Enable**, checksum will be transmitted.



\$%+PRO

Program

Option Bar Code	Option	Alphanumeric Entry
<p>*DAA*</p> <p>Read</p>	<p>Disable</p> <p>Enable</p>	<p>00</p> <p>01 *</p>
<p>*DAB*</p> <p>Checksum Verification</p>	<p>Disable</p> <p>Enable</p>	<p>00</p> <p>01 *</p>
<p>*DAC*</p> <p>Checksum Transmission</p>	<p>Disable</p> <p>Enable</p>	<p>00 *</p> <p>01</p>



%\$\$

Exit

Code-128

Max./Min. code length: Refer to Max./Min. code length of Code-39.

Truncate leading/ending: Refer to Truncate leading/ending of UPCA.

Code Id setting: Refer to Code ID setting of UPCA.

Insertion group selection: Refer to Insertion group selection of UPCA.

Format: The Code-128 can be translated to UCC/EAN-128 format if it starts with FNC1 character. The first FNC1 will be translated to "]C1", and next to be a field separator code as <GS>(1D16).





]C1	Data	<GS>	Data	Checksum
-----	------	------	------	----------



\$%+PRO

Program

Option Bar Code	Option	Alphanumeric Entry
 DAD Max. code length	00-64	00-64 00 *
 DAE Min. code length	00-64	00-64 01 *

 *DAF* Truncate leading	0-15	00-15 00 *
 *DAG* Truncate ending	0-15	00-15 00 *
 *DAH* Code ID setting	00-ffH ASCII code	00-ffH < # > *
 *DAI* Insert group selection	00-44	00-44 00 *
 *DAJ* Format	Standard UCC/EAN-128	00 * 01



Exit

Code-128

Append: When the function is enabled, it won't show the data immediately if scanner read the barcode includes FNC2 code. It will show all data until it read the barcode, which doesn't have FNC2 code.



UCC/ EAN 128 ID setting: To setting the code ID for UCC/EAN-128 output format.

Field separator code: This feature is only used for UCC/EAN-128 format. This Field separator code means you can reassign second or after a FNC1 for your usage. The default of ASCII code is <GS>(1D16).



\$%+PRO

Program

Option Bar Code	Option	Alphanumeric Entry
 *DAK* Append	Disable Enable	00 * 01
 *DAL* UCC/EAN-128 ID setting	00-ffH ASCII code	00-ffH < # > *
 *DAM* Field separator code	00-ffH ASCII code	00-ffH 1DH *



%\$\$

Exit

Code-93

Read: Format

Data Digits (Variable)	Checksum1 (Optional)	Checksum2 (Optional)
---------------------------	-------------------------	-------------------------

Checksum Verification: The checksum is made as the sum module 47 of the numerical values of all data digits.

Checksum Transmission: By setting Enable, checksum will be transmitted.



\$%+PRO

Program

Option Bar Code	Option	Alphanumeric Entry
<p>*CAA*</p> <p>Read</p>	<p>Disable</p> <p>Enable</p>	<p>00 *</p> <p>01</p>
<p>*CAB*</p> <p>Checksum Verification</p>	<p>Disable</p> <p>Enable (two digits)</p>	<p>00</p> <p>01 *</p>
<p>*CAC*</p> <p>Checksum Transmission</p>	<p>Disable</p> <p>Enable</p>	<p>00 *</p> <p>01</p>



%\$\$

Exit

Code-93

Max./Min. code length: Refer to Max./Min. code length of Code-39.

Truncate leading/ending: Refer to Truncate leading/ending of UPCA.





Code Id setting: Refer to Code ID setting of UPCA.



Insertion group selection: Refer to Insertion group selection of UPCA.



\$%+PRO

Program

Option Bar Code	Option	Alphanumeric Entry
 *CAD* Max. code length	00-64	00-64 00 *
 *CAE* Min. code length	00-64	00-64 00 *
 *CAF* Truncate leading	0-15	00-15 00 *
 *CAG* Truncate ending	0-15	00-15 00 *

 *CAH* Code ID setting	00-ffH ASCII code	00-ffH < & > *
 *CAI* Insert group selection	00-44	00-44 00 *



Exit

Code-11

Read: Format

Data Digits (Variable)	Checksum1 (Optional)	Checksum2 (Optional)
---------------------------	-------------------------	-------------------------

Checksum Verification: The checksum is presented as the sum module 11 of all data digits.

Checksum Transmission: By setting **Enable**, checksum1 and checksum2 will be transmitted upon your selected checksum verification method.

Max./Min. code length: Refer to Max./Min. code length of Code-39.

Truncate leading/ending: Refer to Truncate leading/ending of UPCA.

Code Id setting: Refer to Code ID setting of UPCA.

Insertion group selection: Refer to Insertion group selection of UPCA.



\$%+PRO

Program

Option Bar Code	Option	Alphanumeric Entry
<p>*AAA*</p> <p>Read</p>	<p>Disable</p> <p>Enable</p>	<p>00 *</p> <p>01</p>
<p>*AAB*</p> <p>Checksum Verification</p>	<p>Disable</p> <p>One digit</p> <p>Two digits</p>	<p>00</p> <p>01 *</p> <p>02</p>

 * AAC * Checksum Transmission	Disable Enable	00 * 01
 * AAD * Max. code length	00-64	00-64 00 *
 * AAE * Min. code length	00-64	00-64 00 *
 * AAF * Truncate leading	0-15	00-15 00 *
 * AAG * Truncate ending	0-15	00-15 00 *
 * AAH * Code ID setting	00-ffH ASCII code	00-ffH < O > *
 * AAI * Insert group selection	00-44	00-44 00 *



Exit

MSI/Plessey

Read: Format

Data Digits (Variable)	Checksum1 (Optional)	Checksum2 (Optional)
---------------------------	-------------------------	-------------------------

Checksum Verification: The MSI/Plessey has one or two optional checksum digits. The checksum is presented 3 kinds of method **Mod10**, **Mod10/10** and **Mod 11/10**. The checksum1 and checksum2 will be calculated as the sum module 10 or 11 of the data digits.

Checksum Transmission: By setting **Enable**, checksum1 and checksum2 will be transmitted upon your selected checksum verification method.

Max./Min. code length: Refer to Max./Min. code length of Code-39.

Truncate leading/ending: Refer to Truncate leading/ending of UPCA.

Code Id setting: Refer to Code ID setting of UPCA.







Insertion group selection: Refer to Insertion group selection of UPCA.



\$%+PRO

Program

Option Bar Code	Option	Alphanumeric Entry
<p>*KAA*</p> <p>Read</p>	Disable	00 *
	Enable	01
<p>*KAB*</p> <p>Checksum Verification</p>	Disable	00
	Mod 10	01 *
	Mod 10/10	02
	Mod 11/10	03

 *KAC* Checksum Transmission	Disable Enable	00 * 01
 *KAD* Max. code length	00-64	00-64 00 *
 *KAE* Min. code length	00-64	00-64 00 *
 *KAF* Truncate leading	0-15	00-15 00 *
 *KAG* Truncate ending	0-15	00-15 00 *
 *KAH* Code ID setting	00-ffH ASCII code	00-ffH < @ > *
 *KAI* Insert group selection	00-44	00-44 00 *



Exit

UK/Plessey

Read: Format

Data Digits (Variable)	Checksum1+2 (Optional)
---------------------------	---------------------------

Checksum Verification: The UK/Plessey has one or two optional checksum digits. The checksum1 and checksum2 will be calculated as the sum module 10 or 11 of the data digits.

Checksum Transmission: By setting Enable, checksum will be transmitted.

Max./Min. code length: Refer to Max./Min. code length of Code-39.

Truncate leading/ending: Refer to Truncate leading/ending of UPCA.



Code Id setting: Refer to Code ID setting of UPCA.



Insertion group selection: Refer to Insertion group selection of UPCA.



\$%+PRO

Program

Option Bar Code	Option	Alphanumeric Entry
 *LAA* Read	Disable Enable	00 * 01
 *LAB* Checksum Verification	Disable Enable	00 01 *

 *LAC* Checksum Transmission	Disable Enable	00 * 01
 *LAD* Max. code length	00-64	00-64 00 *
 *LAE* Min. code length	00-64	00-64 00 *
 *LAF* Truncate leading	0-15	00-15 00 *
 *LAG* Truncate ending	0-15	00-15 00 *
 *LAH* Code ID setting	00-ffH ASCII code	00-ffH < @ > *
 *LAI* Insert group selection	00-44	00-44 00 *



Exit

Telepen

Read: IATA (International Air Transport Association).

Checksum Verification: The checksum is presented as the sum module 10 or 11 of the data digits.

Checksum Transmission: By setting Enable, checksum will be transmitted.

Max./Min. code length: Refer to Max./Min. code length of Code-39.

Truncate leading/ending: Refer to Truncate leading/ending of UPCA.



Code Id setting: Refer to Code ID setting of UPCA.







Insertion group selection: Refer to Insertion group selection of UPCA.



\$%+PRO

Program

Option Bar Code	Option	Alphanumeric Entry
 *MAA* Read	Disable Enable	00 * 01
 *MAB* Checksum Verification	Disable Enable	00 * 01
 *MAC* Checksum Transmission	Disable Enable	00 * 01

 *MAD* Max. code length	00-64	00-64 00 *
 *MAE* Min. code length	00-64	00-64 00 *
 *MAF* Truncate leading	0-15	00-15 00 *
 *MAG* Truncate ending	0-15	00-15 00 *
 *MAH* Code ID setting	00-ffH ASCII code	00-ffH < S > *
 *MAI* Insert group selection	00-44	00-44 00 *
 *MAJ* Format	Numeric only Full ASCII only	00 * 01



Exit

Standard 2 of 5

Read: Format

Data Digits (Variable)	Checksum1 (Optional)
---------------------------	-------------------------

Check-sum verification: The checksum is made as the sum module 10 of the numerical values of all data digits.

Check-sum transmission: By setting Enable, checksum will be transmitted.

Max./Min. code length: Refer to Max./Min. code length of Code-39.

Truncate leading/ending: Refer to Truncate leading/ending of UPCA.

Code Id setting: Refer to Code ID setting of UPCA.

Insertion group selection: Refer to Insertion group selection of UPCA.



\$%+PRO

Program

Option Bar Code	Option	Alphanumeric Entry
<p>*JAA*</p> <p>Read</p>	<p>Disable</p> <p>Enable</p>	<p>00 *</p> <p>01</p>
<p>*JAB*</p> <p>Check-sum verification</p>	<p>Disable</p> <p>Enable</p>	<p>00 *</p> <p>01</p>

 *JAC* Check-sum transmission	Disable Enable	00 * 01
 *JAD* Max. code length	00-64	00-64 00 *
 *JAE* Min. code length	00-64	00-64 00 *
 *JAF* Truncate leading	0-15	00-15 00 *
 *JAG* Truncate ending	0-15	00-15 00 *
 *JAH* Code ID setting	00-ffH ASCII code	00-ffH < i > *
 *JAI* Insert group selection	00-44	00-44 00 *



Exit

GS1 DataBar Omnidirectional

Read: Format

Data Digits (Variable)	Checksum1 (Optional)
---------------------------	-------------------------

Truncate leading/ending: Refer to Truncate leading/ending of UPCA.





Code Id setting: Refer to Code ID setting of UPCA.



Insertion group selection: Refer to Insertion group selection of UPCA.

UCC/EAN 128 emulation: Refer to Transmission, Code ID transmission must be set as AIM ID enable. Then J1C1 will be identified as prefix of barcode data transmission.



Program

Option Bar Code	Option	Alphanumeric Entry
 *TAA* Read	Disable Enable	00 * 01
 *TAF* Truncate leading	0-15	00-15 00 *
 *TAG* Truncate ending	0-15	00-15 00 *
 *TAH*	00-ffH ASCII code	00-ffH < R4 > *

Code ID setting		
 *TAI* Insert group selection	00-44	00-44 00 *
 *TAK* UCC/EAN128 emulation	Disable Enable	00 * 01



Exit

GS1 DataBar Limited

Read: Format

Data Digits (Variable)	Checksum1 (Optional)
---------------------------	-------------------------

Truncate leading/ending: Refer to Truncate leading/ending of UPCA.

Code Id setting: Refer to Code ID setting of UPCA.

Insertion group selection: Refer to Insertion group selection of UPCA.

UCC/EAN 128 emulation: Refer to UCC/EAN 128 emulation of GS1 DATABAR OMNIDIRECTIONAL.



Program

Option Bar Code	Option	Alphanumeric Entry
 Read	Disable Enable	00 * 01
 Truncate leading	0-15	00-15 00 *
 Truncate ending	0-15	00-15 00 *

 *UAH* Code ID setting	00-ffH ASCII code	00-ffH < RL > *
 *UAI* Insert group selection	00-44	00-44 00 *
 *UAK* UCC/EAN128 emulation	Disable Enable	00 * 01



%\$\$

Exit

GS1 DataBar Expanded

Read: Format

Data Digits (Variable)	Checksum1 (Optional)
---------------------------	-------------------------

Max./Min. code length: Refer to Max./Min. code length of Code-39.

Truncate leading/ending: Refer to Truncate leading/ending of UPCA.

Code Id setting: Refer to Code ID setting of UPCA.

Insertion group selection: Refer to Insertion group selection of UPCA.







UCC/EAN 128 emulation: Refer to UCC/EAN 128 emulation of GS1 DATABAR OMNIDIRECTIONAL.



\$%+PRO

Program

Option Bar Code	Option	Alphanumeric Entry
<p>*VAA*</p> <p>Read</p>	<p>Disable</p> <p>Enable</p>	<p>00 *</p> <p>01</p>
<p>*VAD*</p> <p>Max. code length</p>	<p>00-99</p>	<p>00-99</p> <p>99 *</p>

 *VAE* Min. code length	00-99	00-99 01 *
 *VAF* Truncate leading	0-15	00-15 00 *
 *VAG* Truncate ending	0-15	00-15 00 *
 *VAH* Code ID setting	00-ffH ASCII code	00-ffH < RX > *
 *VAI* Insert group selection	00-44	00-44 00 *
 *VAK* UCC/EAN128 emulation	Disable Enable	00 * 01



Exit

China Post

Read: Format

Data Digits (Variable)	Checksum1 (Optional)
---------------------------	-------------------------

Max./Min. code length: Refer to Max./Min. code length of Code-39.

Truncate leading/ending: Refer to Truncate leading/ending of UPCA.



Code Id setting: Refer to Code ID setting of UPCA.





Insertion group selection: Refer to Insertion group selection of UPCA.



\$%+PRO

Program

Option Bar Code	Option	Alphanumeric Entry
 *SAA* Read	Disable Enable	00 * 01
 *SAD* Max. code length	00-64	00-64 11 *
 *SAE* Min. code length	00-64	00-64 11 *

 *SAF* Truncate leading	0-15	00-15 00 *
 *SAG* Truncate ending	0-15	00-15 00 *
 *SAH* Code ID setting	00-ffH ASCII code	00-ffH < t > *
 *SAI* Insert group selection	00-44	01-44 00 *



Exit

Italian Pharmacode

Read: Format

Data Digits (Variable)	Checksum1 (Optional)
---------------------------	-------------------------

Max./Min. code length: Refer to Max./Min. code length of Code-39.

Truncate leading/ending: Refer to Truncate leading/ending of UPCA.

Code Id setting: Refer to Code ID setting of UPCA.



Insertion group selection: Refer to Insertion group selection of UPCA.







Leading “A”: If this function is enabled, each prefix of data shall be A.



\$%+PRO

Program

Option Bar Code	Option	Alphanumeric Entry
 *WAA* Read	Disable Enable	00 * 01
 *WAD* Max. code length	00-64	00-64 12 *

 *WAE* Min. code length	00-64	00-64 09 *
 *WAF* Truncate leading	0-15	00-15 00 *
 *WAG* Truncate ending	0-15	00-15 00 *
 *WAH* Code ID setting	00-ffH ASCII code	01-ffH < p > *
 *WAI* Insert group selection	00-44	00-44 00 *
 *WAJ* Leading "A"	Disable Enable	00 * 01



Exit

Test Chart

CODABAR-PARA



a154987a

CODE-11 PARA

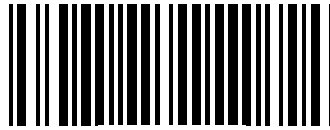

654215

CODE-128 PARA

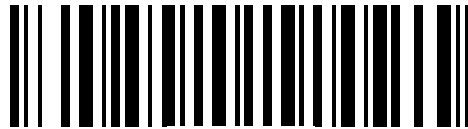

258963

CODE-39 PARA

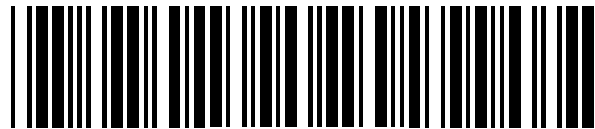

741258

CODE-93 PARA

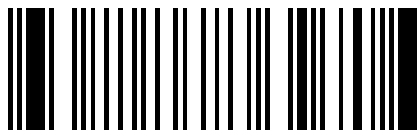

951263

EAN-13 PARA

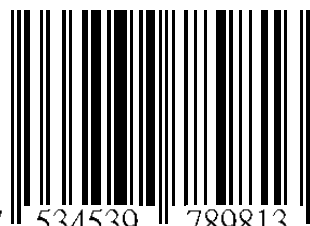

7 534539 789813

STANDRAD-25 PARA



65978

EAN-8 PARA



9456 2156

INDUSTRIAL-25 PARA

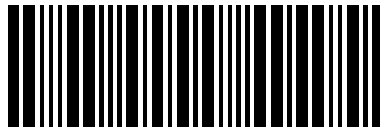

04976

UPCE PARA

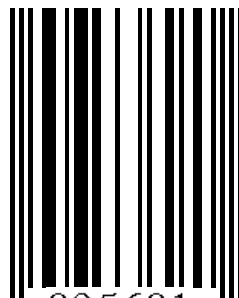

0 095601 1

INTERLEAVED-25 PARA

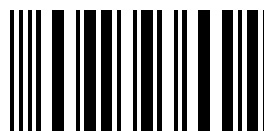

46820

MATRIX 25 PARA



4563535663

MSI/PLESSEY PARA

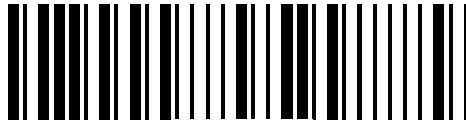

754268

UPCA PARA



5 73648 64734 5

UK/PLESSEY PARA



64872

GS1 DATABAR OMNIDIRECTIONAL

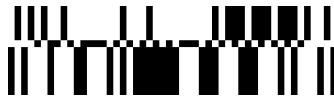

ASCII Code Table Note: For keyboard wedge only.

L \ H	0	1	0	1
0	Null		NUL	DLE
1	Up	F1	SOH	DC1
2	Down	F2	STX	DC2
3	Left	F3	ETX	DC3
4	Right	F4	EOT	DC4
5	PgUp	F5	ENQ	NAK
6	PgDn	F6	ACK	SYN
7		F7	BEL	ETB
8	Bs	F8	BS	CAN
9	Tab	F9	HT	EM
A		F10	LF	SUB
B	Home	Esc	VT	ESC
C	End	F11	FF	FS
D	Enter	F12	CR	GS
E	Insert	Ctrl+	SO	RS
F	Delete	Alt+	SI	US

L \ H	2	3	4	5	6	7
0	SP	0	@	P	`	p
1	!	1	A	Q	a	q
2	"	2	B	R	b	r
3	#	3	C	S	c	s
4	\$	4	D	T	d	t
5	%	5	E	U	e	u
6	&	6	F	V	f	v
7	'	7	G	W	g	w
8	(8	H	X	h	x
9)	9	I	Y	i	y
A	★	:	J	Z	j	z
B	+	;	K	[k	{
C	,	<	L	\	l	
D	-	=	M]	m	}
E	.	>	N	^	n	~
F	/	?	O	_	o	DEL

Parameter Setting List



\$%+PRO

Program



!BS

Barcode standard parameter setting list

If you wish to display the current configuration of your AS-8000 scanner over the host terminal/computer, scan the Barcode standard parameter setting list bar code.



!BU

Unique parameter list

If you wish to display the unique parameter setting list, scan the unique parameter list bar code



!SY

System parameter setting list

If you wish to display the product information and revision number for your AS-8000 scanner over the host terminal/computer, scan the System parameter setting list bar code.



!ST

String setting list

If you wish to display the string format list, scan the String setting list bar code.



!VR

Firmware version list

If you wish to display the firmware version, scan the Firmware version list.

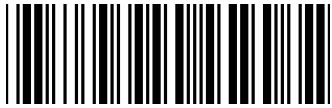

!IN

WARNING: Default value initialization

If you wish to return the AS-8000 scanner to all the factory default settings, scan the Default value initialization bar code.



%\$\$

Exit



/0 **0**



/1 **1**



/2 **2**



/3 **3**



/4 **4**



/5 **5**



/6 **6**



/7 **7**



/8 **8**



/9 **9**



/A **A**



/B **B**



/C **C**



/D **D**



/E **E**



/F **F**



/%% **Finish**