

Magellan™ 1100i

On-Counter Presentation Omnidirectional Bar Code Reader



Product Reference Guide

Datalogic ADC, Inc.

959 Terry Street
Eugene, OR 97402
USA

Telephone: (541) 683-5700

Fax: (541) 345-7140

© 2005-2016 Datalogic ADC, Inc.

An Unpublished Work - All rights reserved. No part of the contents of this documentation or the procedures described therein may be reproduced or transmitted in any form or by any means without prior written permission of Datalogic ADC, Inc. or its subsidiaries or affiliates ("Datalogic" or "Datalogic ADC"). Owners of Datalogic products are hereby granted a non-exclusive, revocable license to reproduce and transmit this documentation for the purchaser's own internal business purposes. Purchaser shall not remove or alter any proprietary notices, including copyright notices, contained in this documentation and shall ensure that all notices appear on any reproductions of the documentation.

Should future revisions of this manual be published, you can acquire printed versions by contacting your Datalogic representative. Electronic versions may either be downloadable from the Datalogic website (www.datalogic.com) or provided on appropriate media. If you visit our website and would like to make comments or suggestions about this or other Datalogic publications, please let us know via the "Contact Datalogic" page.

Disclaimer

Datalogic has taken reasonable measures to provide information in this manual that is complete and accurate, however, Datalogic reserves the right to change any specification at any time without prior notice.

Datalogic and the Datalogic logo are registered trademarks of Datalogic S.p.A. in many countries, including the U.S.A. and the E.U. All other brand and product names may be trademarks of their respective owners.

Magellan is a registered trademark of Datalogic ADC, Inc. in many countries, including the U.S.A. and All-Weighs, FirstStrike, SmartSentry and SurroundScan are registered trademarks of Datalogic ADC, Inc. in the U.S.A. OmegaTek, Produce Rail, Productivity Index Reporting, and ScaleSentry are all trademarks of Datalogic ADC, Inc.

Patents

See www.patents.datalogic.com for patent list.

Table of Contents

Chapter 1. Getting Started	1
About This Manual	1
Manual Conventions	1
Connecting the Scanner	2
Programming	3
Using the Programming Barcodes	3
Resetting the Standard Product Defaults	3
LED and Beeper Indicators	4
Error Codes	5
Chapter 2. General Features	7
Double Read Timeout for Linear Labels	7
Double Read Timeout for 2D Labels	9
Label Gone Timeout	10
Productivity Index Reporting (PIR)	10
Sleep Mode	11
LED and Beeper Indicators	13
Power On Alert	13
ERI Active State High	13
ERI Timeout	14
Good Read: When to Indicate	15
Good Read Beep Control	16
Good Read Beep Frequency	16
Good Read Beep Length	17
Good Read Beep Volume	18
Green Spot	18
Aiming Pointer Settings	19
Scanning Features	20
Targeted Scanning Mode	20
Target Mode Active Time	20
Target Mode Linger Time	21
Wake Up Intensity	22
Image Capture	23
How to Capture an Image	23
Image Compression	24
Image Size	24
Image Brightness	25
Image Contrast	25
Cell Phone Mode	26
Cell Phone Mode Enable	26
Cell Phone Detection Sensitivity	27
Cell Phone in Target Mode	29
Chapter 3. Interface Related Features	31
Interface Selection	33
Interface Features	35
Obey/Ignore Host Commands	35
Host Transmission Buffers	36
RS-232 Interface Features	37
Hardware Flow Control	39
Intercharacter Delay	40
Software Flow Control	41
Host Echo Quiet Interval	42
Signal Voltage: Normal/TTL	43
Beep on ASCII BEL	44
Beep on Not on File	44

ACK NAK Options	45
ACK Character	46
NAK Character	46
Retry on ACK NAK Timeout	47
ACK NAK Timeout Value	47
ACK NAK Retry Count	48
ACK NAK Error Handling	49
Transmission Failure Indication	50
USB-OEM Interface Features	50
USB-OEM Device usage	50
IBM	51
IBM Transmit Labels in Code 39 Format	51
Keyboard Wedge	52
USB Keyboard	52
Caps Lock State	54
USB COM Interface Set-up	58
Chapter 4. Data Editing	59
Data Editing Overview	59
Please Keep In Mind...	59
Global Prefix/Suffix	60
AIM ID	62
Label ID	63
Case Conversion	70
Character Conversion	71
Chapter 5. Symbolologies	73
UPC-A	73
Disable/Enable UPC-A	73
Check Digit Transmission	74
Expand UPC-A to EAN-13	74
Number System Transmission	75
UPC-A Minimum Reads	75
UPC-A In-store Minimum Reads	76
UPC-E	77
Disable/Enable UPC-E	77
Check Digit Transmission	77
Number System Digit	78
Expand to UPC-E to UPC-A	78
Expand UPC-E to EAN13	79
Minimum Reads	79
GTIN	80
Expand UPC/EAN to GTIN	80
EAN-13	81
Disable/Enable EAN-13	81
Check Digit Transmission	81
EAN-13 Flag 1 Character	82
ISBN	82
Minimum Reads	83
EAN-8	84
Disable/Enable EAN-8	84
Check Digit Transmission	84
Minimum Reads	85
EAN Two-Label	86
EAN Two-Label Type 1	86
EAN Two-Label Type 2	87
EAN Two-Label Type 3	88
EAN Two-Label Type 4	89
EAN Two-Label Combined Transmission	90
EAN Two-Label Minimum Reads	91
Price Weight Check Digit	92
Add-ons	93

2-Digit Addons Minimum Reads	95
5-Digit Addons Minimum Reads	96
GS1 DataBar Omnidirectional / Stacked Omnidirectional	97
Disable/Enable GS1 DataBar Omnidirectional	97
UCC/EAN 128 Emulation	97
Minimum Reads	98
GS1 DataBar Expanded / Expanded Stacked	99
Disable/Enable GS1 DataBar Expanded	99
GS1-128 Emulation	99
Length Control	100
GS1 DataBar Expanded Length 1, Length 2 Programming Instructions	101
Minimum Reads	102
Coupon Read Control	103
GS1 DataBar Limited	104
Disable/Enable GS1 DataBar Limited	104
GS1-128 Emulation	104
Minimum Reads	105
Code 39	106
Disable/Enable Code 39	106
Check Character Calculation	106
Check Character Transmit	107
Start/Stop Characters	107
Code 39 Full ASCII	108
Length Control	109
Code 39 Length 1, Length 2 Programming Instructions	110
Quiet Zones	110
Code 39 Stitching	111
Minimum Reads	111
Code 32 Italian Pharmacode	112
Disable/Enable Code 32 Italian Pharmacode	112
Start/Stop Characters	112
Code 32 Italian Pharmacode — continued	113
Check Character Transmit	113
Code 128	114
Disable/Enable Code 128	114
Disable/Enable EAN 128	114
Transmit Function Characters	115
Length Control	116
Code 128 Length 1, Length 2 Programming Instructions	117
Code 128 Conversion to Code 39	117
Code 128 Stitching	118
Minimum Reads	118
Interleaved 2 of 5	119
Disable/Enable Interleaved 2 of 5	119
Check Digit Calculation	119
Check Digit Transmit	120
Length Control	121
Interleaved 2 of 5 Length 1, Length 2 Programming Instructions	122
Interleaved 2 of 5 Stitching	123
Minimum Reads	124
Codabar	125
Disable/Enable Codabar	125
Check Character Verification	125
Check Character Transmit	126
Length Control	127
Codabar Length 1, Length 2 Programming Instructions	128
Quiet Zones	128
Start/Stop Character Type	129
Start/Stop Character Transmission	129
Start/Stop Character Match	130
Codabar Stitching	130
Minimum Reads	131

Code 93	132
Disable/Enable Code 93	132
Length Control	133
Code 93 Length 1, Length 2 Programming Instructions	134
Code 93 Stitching	135
Minimum Reads	135
MSI/Plessey	136
Disable/Enable MSI/Plessey	136
Check Digit Verification	136
Check Digit Transmit	137
Number of Check Characters	137
Length Control	138
MSI/Plessey Length 1, Length 2 Programming Instructions	139
MSI/Plessey Stitching	140
Minimum Reads	141
Standard 2 of 5	142
Disable/Enable Standard 2 of 5	142
Check Digit Verification	142
Check Digit Transmit	143
Length Control	144
Standard 2 of 5 Length 1, Length 2 Programming Instructions	145
Standard 2 of 5 Stitching	146
Minimum Reads	147
Chapter 6. 2D Symbolologies.....	149
2D Symbolologies	149
2D Decode Time Max	149
PDF 417	150
Disable/Enable PDF 417	150
Length Control	151
PDF 417 Length 1, Length 2 Programming Instructions	152
Micro PDF 417	153
Disable/Enable Micro PDF 417	153
Length Control	154
Micro PDF 417 Length 1, Length 2 Programming Instructions	155
Datamatrix	156
Disable/Enable Datamatrix	156
Length Control	157
Datamatrix Length 1, Length 2 Programming Instructions	158
QR Code	159
Disable/Enable QR Code	159
Length Control	160
QR Code Length 1, Length 2 Programming Instructions	161
Maxicode	162
Disable/Enable Maxicode	162
Length Control	163
Maxicode Length 1, Length 2 Programming Instructions	164
Aztec	165
Disable/Enable Aztec	165
Length Control	166
Aztec Length 1, Length 2 Programming Instructions	167
Composite Labels	168
Disable/Enable GS1 DataBar Omnidirectional 2D Component	168
Disable/Enable GS1 DataBar Expanded 2D Component	168
Disable/Enable GS1 DataBar Limited 2D Component	169
Chapter 7. Advanced Decoding Features.....	171
Pharmacy Patterns	171
Inverse Label Reading	172
Appendix A. Product Specifications.....	173
Optical and Read Performance Parameters	173

Scanner Dimensions	173
Physical Properties	174
Electrical Parameters	174
Environmental Parameters	174
Other Parameters	174
Chapter B. Cable Pinouts	175
Standard Cable Pinouts (Primary Interface Cables)	175
RS-232	175
IBM Port 5B/9B/17	175
USB-OEM	176
USB, USB Keyboard & USB COM	176
Keyboard Wedge	176
Appendix C. Alpha-Numeric Pad	177
Appendix D. Default Settings	179
Defaults by Symbology	179
Interface Default Exceptions	180
IBM Interfaces	180
RS-232 Wincor/Nixdorf	181
Keyboards	182
Appendix E. Keyboard Function Key Mappings.....	183
Keyboard Model Cross Reference	183
Appendix F. Host Commands	191
Accepting RS-232 Commands	191
Appendix G. Sample Symbols.....	193
1D Symbol Samples	193
2D Sample Symbols	195
Composite Sample Symbols	196

NOTES

Chapter 1

Getting Started

The Magellan™ 1100i Omni-Directional Imaging Scanner offers hands-free scanning for small, easily handled items and handheld scanning for bulkier items. Its aggressive imaging performance and intuitive operation reduces user training and speeds checkout for better customer service.

About This Manual

This manual presents advanced user information which includes connection, programming, product and cable specifications, and other useful references. For additional information, such as installation, maintenance, troubleshooting and warranty information, see the Quick Reference Guide (QRG). Copies of other publications for this product are downloadable free of charge from the website listed on the back cover of this manual.

On leaving the factory, units are programmed for the most common terminal and communications settings. If you need to change these settings, custom programming can be accomplished by scanning the barcodes in this guide.

Bold text and a yellow-highlighted background indicates the most common default setting for a feature/option.

Manual Conventions

The symbols listed below are used in this manual to notify the reader of key issues or procedures that must be observed when using the scanner:



Notes contain information necessary for properly diagnosing, repairing and operating the scanner.

NOTE



The CAUTION symbol advises you of actions that could damage equipment or property.

CAUTION

Connecting the Scanner

The scanner kit you ordered to match your interface should provide a compatible cable for your installation. Use the appropriate instructions below to connect the scanner to the terminal, PC or other host device.

Upon completing the connection via the appropriate interface instructions below, proceed to the [Interface Related Features](#) section of this manual and scan the barcode to select the correct interface type.

RS-232 Serial Connection — Turn off power to the terminal/PC and connect the scanner to the terminal/PC serial port via the RS-232 cable as shown in [Figure 1](#). If the terminal will not support POT (Power Off the Terminal) to supply scanner power, use the approved power supply (AC Adapter). Plug the AC Adapter barrel connector into the socket on the RS-232 cable connector and the AC Adapter plug into a standard power outlet.

Figure 1. RS-232 Serial or USB Connection using A/C Adapter

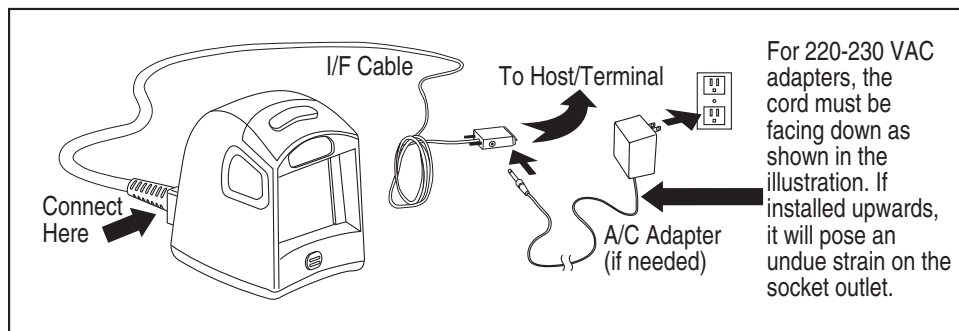

USB Connection — Connect the scanner to a USB port on the terminal/PC using the correct USB cable for the interface type you ordered. Reference [Figure 1](#) and [Figure 2](#).



NOTE

USB installations may require a power connection via an approved A/C Adapter as shown in [Figure 1](#). For example, this would be the case if the scanner is connected along with a number of other devices to a non-powered USB hub.

Figure 2. Other Connection Types

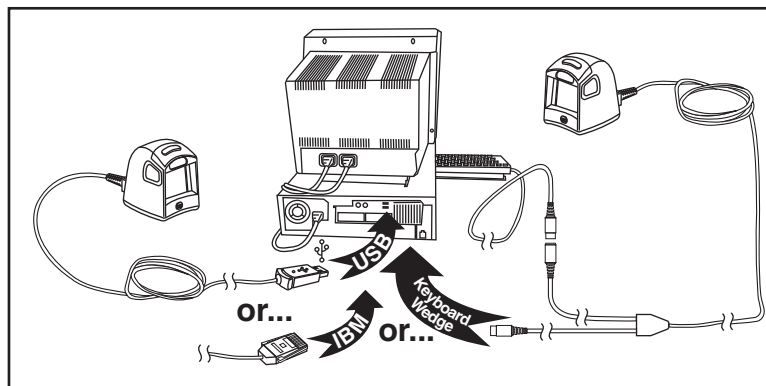

IBM Connection — Connect the scanner to the IBM port on the terminal/PC using the correct IBM cable. Reference [Figure 2](#).

Keyboard Wedge Connection — Before connection, turn off power to the terminal/PC. The Keyboard Wedge cable has a ‘Y’ connection from the scanner. Connect the female to the male end from the keyboard and the remaining end at the keyboard port at the terminal/PC. Reference [Figure 2](#).

Programming

The scanner is typically factory-configured with a set of default features standard to the interface type you ordered. After scanning the interface barcode from the [Interface Related Features](#) section, you can select other options and customize your scanner through use of the instructions and programming barcodes available in that section and also the [Data Editing](#) and [Symbologies](#) chapters of this manual.

Using the Programming Barcodes

This manual contains feature descriptions and barcodes which allow you to reconfigure your scanner. Some programming barcode labels, like the label below for resetting defaults, require only the scan of that single label to enact the change. Most of the programming labels in this manual, however, require the scanner to be placed in Programming Mode prior to scanning them. Scan a START/END barcode once to enter Programming Mode. Once the scanner is in Programming Mode, you can scan a number of parameter settings before scanning the START/END barcode a second time, which will then accept your changes, exit Programming Mode and return the scanner to normal operation.

Resetting the Standard Product Defaults

If you are unsure of what programming options are in your scanner, or you’ve changed some options and want the factory settings restored, scan the *Standard Product Default Settings* barcode below. This will copy the factory configuration for the currently active interface to the current configuration.



Standard Product Default Set-

The programming section lists the factory default settings for each of the menu commands for the standard RS-232 interface in **BOLD** text on the following pages. Exceptions to default settings for the other interfaces can be found in [Appendix D, Default Settings](#).

LED and Beeper Indicators

The scanner's beeper sounds and its green LED illuminates to indicate various functions or errors on the scanner. The tables below list these indications. One exception to the behaviors listed in the tables is that the scanner's functions are programmable, and may or may not be turned on. For example, certain indications, such as the power-up beep can be disabled using programming barcode labels.

Green LED Indications

LED INDICATION	INDICATION	COMMENT
Power-on indication	Bright green flash	Indicates the scanner has finished all its power up tests and is now ready for operation.
Good Read Indication	Bright green flash	Indicates a barcode has been read and decoded.
Scanner Ready	Constant dim green	The scanner is ready for operation.
Sleep Mode	Constant green flash (100mS on, 1900mS off)	The scanner is in Sleep Mode. To wake the scanner up, move an object in front of its window or press the button atop the unit.
Host Disable	Constant green flash at 1 Hz (100mS on, 900mS off)	The scanner is disabled due to receiving a disable command from the POS terminal.
Diagnostics	Varies (see Error Codes on page 1-5 for more information)	The LED can provide diagnostic feedback if the scanner discovers a problem during SelfTest.
Prog. Mode	See Host Disable above.	The scanner is in Programming Mode.

BEEPER FUNCTIONS

BEEPER INDICATION	INDICATION	COMMENT
Power On Beep	Single beep	The Power-On LED indication is a configurable feature which can be enabled or disabled. When enabled, this beep indicates the scanner has finished all its power up tests and is now ready for operation.
Good Read Indication	Single beep	The good read beep indication is configurable. Options include: Enable/disable, frequency, duration and volume. See the Product Reference Guide (PRG) for more information.
Diagnostics	Varies (see Error Codes on page 1-5 for more information)	The Beeper can provide diagnostic feedback if the scanner discovers a problem during SelfTest.
Programming Mode Indications	Varies depending upon the feature(s) being configured.	The Beeper will sound as programming barcode labels are scanned, indicating progress during scanner configuration.

Error Codes

Upon startup, if the scanner flashes its indicator LED or sounds an unexpected series of beep tones (other than normal power-up indications), this means the scanner has not passed its automatic Selftest and has entered FRU¹ isolation mode. If the scanner is reset or the trigger is pulled, the sequence will be repeated. The following table describes the LED flashes/beep codes associated with an error found.

NUMBER OF LED FLASHES/ BEEPS	ERROR	CORRECTIVE ACTION
1	Configuration	Contact Helpdesk for assistance
2	Interface PCB	
6	Main PCB	
10	Button Error	
12	Imager Module	
13	Software ID Failure	
14	CPLD/Code Mismatch	

1. Field Replaceable Unit (FRU)





NOTES

Chapter 2



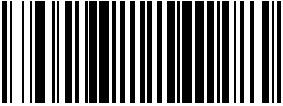
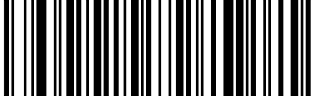

General Features

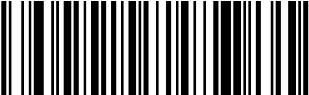
Double Read Timeout for Linear Labels

This Double Read Timeout feature sets a time limit that determines how much time must pass before reading the same linear label again (e.g. two identical items in succession).

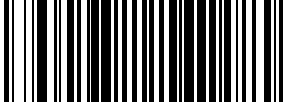
	START / END
PROGRAMMING BARCODES	
0.1 Second	
	0.2 Second
0.3 Second	
	0.4 Second DEFAULT
0.5 Second	
	0.6 Second

Double Read Timeout for Linear Labels – cont.

	START / END
PROGRAMMING BARCODES	
0.7 Second	
	0.8 Second
0.9 Second	
	1 Second



Double Read Timeout for 2D Labels

This Double Read Timeout feature specifies the minimum allowable time between consecutive good reads of the same PDF 417, Micro PDF 417 Data Matrix, QR Code, Maxicode, Aztec or Composite label.

	START / END
PROGRAMMING BARCODES	
1.5 Seconds	
	1.65 Seconds
1.8 Seconds DEFAULT	
	1.95 Seconds
2 Seconds	
	2.55 Seconds

Label Gone Timeout

This feature sets the time after the last label segment is seen before the scanner prepares for a new label.

START / END	
PROGRAMMING BARCODES	
<p>Sets the label gone timeout duration using hex values from 000 to 255 in increments of ten milliseconds (10ms or 0.01 seconds). To configure this feature, scan the “START/END” barcode above to place the unit in Programming Mode, then the “Set Linear Label Gone Timeout,” followed by the three digits (zero padded) from the Alphanumeric table in Appendix C, Alpha-Numeric Pad representing the desired time value. Exit programming mode by scanning the “START/END” barcode again.</p> <p style="text-align: center;">DEFAULT SETTING FOR THIS FEATURE: 320 milliseconds (032)</p>	
	Set Linear Label Gone Timeout



Productivity Index Reporting (PIR)

When PIR is enabled, label quality data is appended to decoded data before being presented to the POS. The PIR feature allows the scanner to provide information to an external computer, indicating how easy the label was to read.





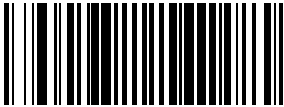



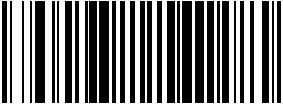

NOTE

This value-added feature is a factory-programmed option. Contact your dealer for information about upgrading your system to include this advanced capability.





	START / END
PROGRAMMING BARCODES	
Disable DEFAULT	
	Enable

Sleep Mode

This feature specifies the amount of time with no barcode reads before the scanner enters sleep mode.

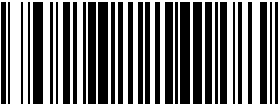
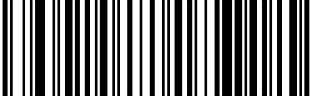
	START / END
PROGRAMMING BARCODES	
	Disable Sleep Mode
15 Seconds	
	30 Seconds
1 Minute	
	2 Minutes
3 Minutes	
	4 Minutes
5 Minutes	



Sleep Mode – cont.

START / END	
PROGRAMMING BARCODES	
	6 Minutes
7 Minutes	
	8 Minutes
9 Minutes	
	10 Minutes DEFAULT
12 Minutes	
	15 Minutes
30 Minutes	
	1 Hour

LED and Beeper Indicators

Power On Alert

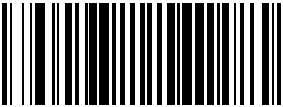
Disables or enables the indication (a single beep) that the scanner has finished all its power up tests and is now ready for operation.

	START / END
PROGRAMMING BARCODES	
Disable	
	Enable DEFAULT

ERI Active State High

This setting specifies the active-state polarity of the External Read Indicator signal to High; the inactive state is the opposite polarity.



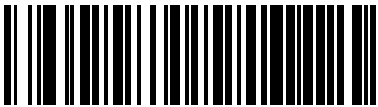

NOTE

Contact Technical Support for assistance in changing the ERI Active State to Low if needed. Configuration of this feature is available only through use of a special cable.

START / END	
PROGRAMMING BARCODES	
	ERI Active State = High

ERI Timeout

Specifies the amount of time the External Read Indicator (ERI) signal is held active for a good read.

START / END	
PROGRAMMING BARCODES	
<p>Sets the ERI timeout duration using hex values from 000 to 255 in increments of ten milliseconds (10ms or 0.01 seconds). To configure this feature, scan the “START/END” barcode above to place the unit in Programming Mode, then the “Set ERI Timeout,” followed by the two digits (zero padded) from the Alphanumeric table in Appendix C, Alpha-Numeric Pad representing the desired time value. Exit programming mode by scanning the “START/END” barcode again.</p> <p style="text-align: center;">DEFAULT SETTING FOR THIS FEATURE: 20 milliseconds (02)</p>	
	Set ERI Timeout

Good Read: When to Indicate





This feature specifies when the scanner will provide indication (beep and/or flash its green LED) upon successfully reading a barcode. Choices are:

- Good Read = Indicate after decode
- Good Read = Indicate after transmit
- Good Read = Indicate after CTS goes inactive, then active



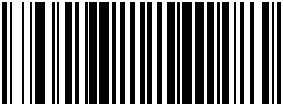

This option (Indicate after CTS goes inactive, then active), which uses CTS, is only valid for RS-232 interfaces.

NOTE

	START / END
PROGRAMMING BARCODES	
After Decode DEFAULT	
	After Transmit
After CTS goes inactive, then active	



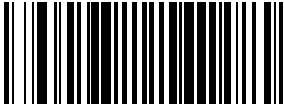

Good Read Beep Control

This feature enables/disables the scanner's ability to beep upon a successful decode of a barcode.

	START / END
PROGRAMMING BARCODES	
Disable	
	Enable DEFAULT

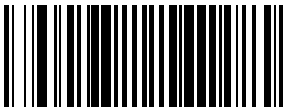

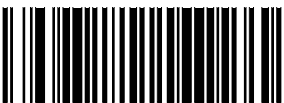



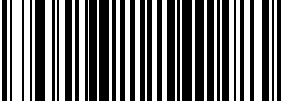

Good Read Beep Frequency

Adjusts the good read beep to sound at a selectable low, medium or high frequency, selectable from the list below. (Controls the beeper's pitch/tone.)

	START / END
PROGRAMMING BARCODES	
Low	
	Medium DEFAULT
High	



Good Read Beep Length

Specifies the duration of a good read beep.

	START / END
PROGRAMMING BARCODES	
60msec	
	80msec DEFAULT
100msec	
	120msec
140msec	
	160msec
180msec	
	200msec

Good Read Beep Volume

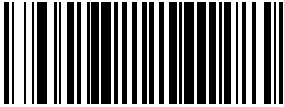
Selects the beeper volume (loudness) upon a good read beep. There are three selectable volume levels.

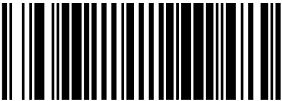
	START / END
PROGRAMMING BARCODES	
Low	
	Medium
High DEFAULT	

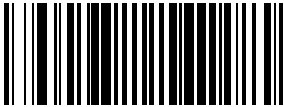
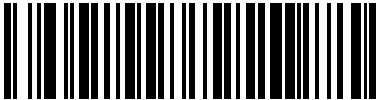
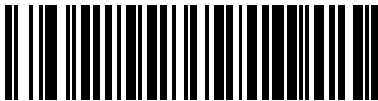

Green Spot

This feature enables / disables the green spot activation when good read is activated.

	START / END
PROGRAMMING BARCODES	
Disable DEFAULT	
	Enable

Aiming Pointer Settings

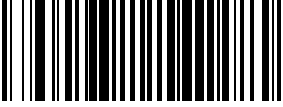
Enables/disables Aiming Pointer for all symbologies.

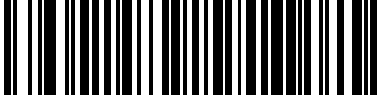
	START / END
PROGRAMMING BARCODES	
Disable DEFAULT	
	Enable

Scanning Features

Targeted Scanning Mode

Upon pressing the button, the scanner will project an aiming pattern to assist in centering over the barcode. Scanning then takes place as soon as the button is released.



NOTE

When add-ons are enabled and a barcode is being read while in Targeted Mode, position the pointer at or near the end of the base label to ensure the scanner will read both the base and add-on label.

Targeted Scanning Mode will read barcodes in any orientation.

The scanner will return to full pattern Omni-directional Mode after Target Mode Active Time has elapsed.

Configuration options for Targeted Scanning Mode are:

- Target Mode Active Time
- Target Mode Linger Time





Target Mode Active Time

Specifies the time duration the scanner attempts to decode labels while in the targeted mode of operation.

	START / END
PROGRAMMING BARCODES	
Extra Short Duration	
	Short Duration
Medium Duration DEFAULT	
	Long Duration

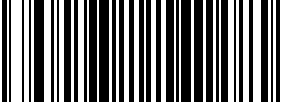





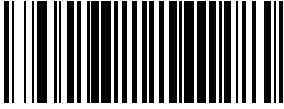

Target Mode Linger Time

Specifies the time duration the scanner remains in the targeted mode of operation after reading a barcode before reverting to Omni-directional Mode.

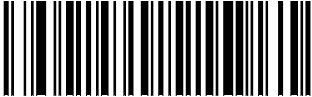
START / END	
PROGRAMMING BARCODES	
	Short Duration
Medium Duration DEFAULT	
	Long Duration

Wake Up Intensity

This feature indicates the percentage of ambient light change which will trigger the scanner to wake up from Sleep Mode. Lower settings provide greater sensitivity. The selectable range for this setting is 5% to 15%.

	START / END
PROGRAMMING BARCODES	
5%	
	6%
7%	
	8%
9%	
	10% DEFAULT
11%	
	12%

Wake Up Intensity – cont.





	START / END
PROGRAMMING BARCODES	
13%	
	14%
15%	

Image Capture

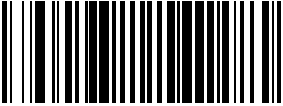

NOTE

This function is **ONLY** available for scanners having a button.

Image capture requires that the scanner use the Standard RS-232 or USB COM interface **ONLY**.

The scanner reverts to default reading mode after image capture and transfer.

How to Capture an Image

To initiate an Image Capture, scan the IMAGE CAPTURE label below, and press the button. A targeting “pointer” will be illuminated while the button is pressed.

Upon release of the button, the image is captured and transmitted to the host. If the button is not pushed within 30 seconds, the scanner will return to barcode reading (scanning) mode.

By default, images are captured as 752 x 480 JPEG format with a minimum compression ratio, and are displayed via the host application software.



IMAGE CAPTURE

Image Compression

Specifies the starting image compression factor for JPEG images. A higher number specifies a higher quality image with less compression than a relative lower number for the same image.

A value of 100 means minimal compression. A value of 1 means maximum compression at a loss of quality. Follow these steps to program this feature:

1. Scan the START barcode.
2. Scan the Set Image Compression barcode.
3. Turn to **Alpha-Numeric Pad** and scan the two digits (zero-padded) representing the desired compression. The configurable range is 01-0x64 by increments of 01.
4. Scan the END barcode.



START / END	
PROGRAMMING BARCODES	
	Set Image Compression DEFAULT SETTING IS 100 (minimal compression — higher quality)

Image Size

Specifies the size of the image capture. Choices are:

- WVGA
- VGA

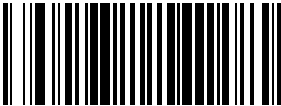

START / END	
PROGRAMMING BARCODES	
	Image Size = WVGA DEFAULT
Image Size = VGA	

Image Brightness

This feature sets the image brightness value. Follow these instructions to configure this feature:

1. Scan the START barcode.
2. Scan the Set Image Brightness barcode.
3. Turn to [Alpha-Numeric Pad](#) and scan the two digits (zero-padded) representing the desired brightness in decimal notation. The configurable range is 01-0x0A by increments of 01.
4. Scan the END barcode.

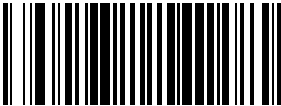
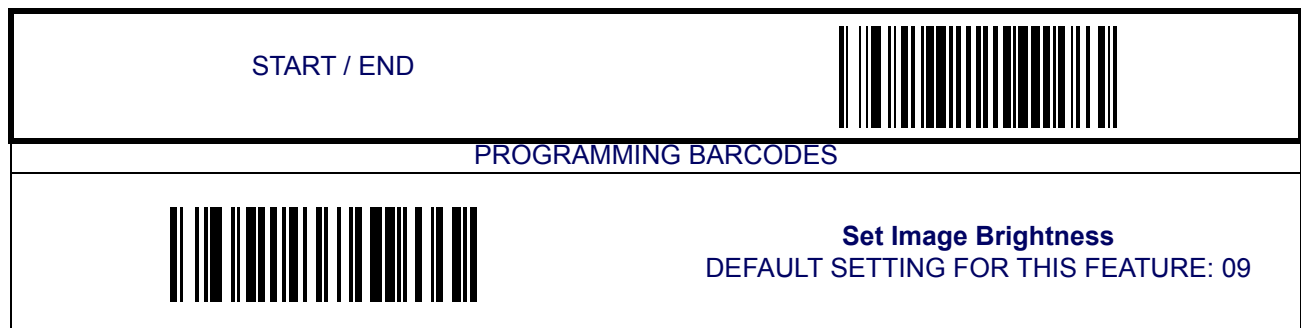
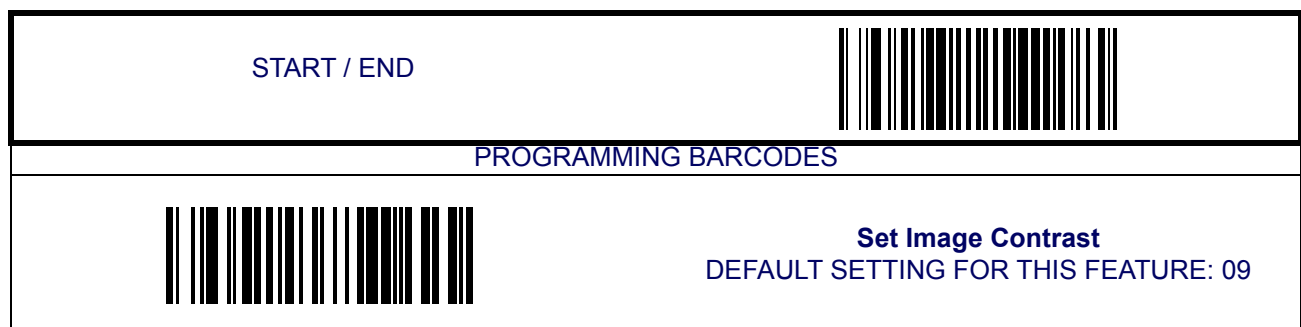

Image Contrast

This feature sets the image contrast value. Follow these instructions to configure this feature:

1. Scan the START barcode.
2. Scan the Set Image Contrast barcode.
3. Turn to [Alpha-Numeric Pad](#) and scan the two digits (zero-padded) representing the desired contrast in decimal notation. The configurable range is 01-0x0A by increments of 01.
4. Scan the END barcode.





Cell Phone Mode

Cell Phone Mode enables the scanner to read barcodes on a cell phone display.

Cell Phone Mode Enable

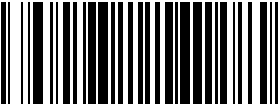
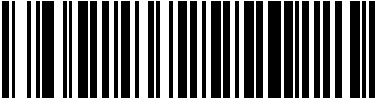
Enables/disables Cell Phone Mode.

START / END	
PROGRAMMING BARCODES	
	Cell Phone Mode = Disable DEFAULT
Cell Phone Mode = Enable	

Cell Phone Detection Sensitivity

These settings control various pixel characteristics in order to optimize cell phone detection. Follow these instructions to configure this feature:

1. Determine which sensitivity level is desired (high, medium or low).
2. Scan the START barcode to place the scanner in Programming Mode.
3. Scan the three barcodes for the detection sensitivity desired.









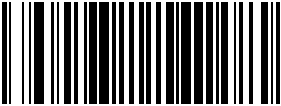
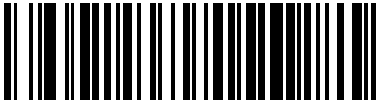
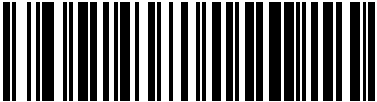
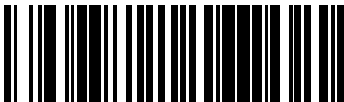



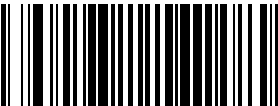

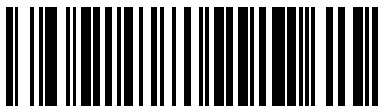

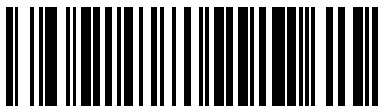
Unlike typical feature settings, Cell Phone Detection Sensitivity requires the scanning of THREE barcodes to set the level. For example, to set a high detection sensitivity level, scan barcodes HIGH #1, HIGH #2 and HIGH #3.

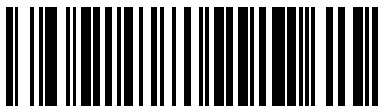
NOTE

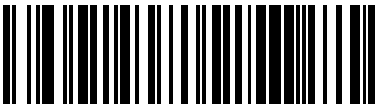
4. Scan the END barcode.

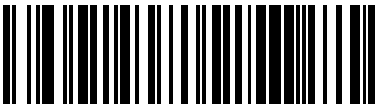
START / END	
PROGRAMMING BARCODES	
<p>Cell Phone Detection Sensitivity = HIGH</p> <div style="display: flex; justify-content: space-around; align-items: center;"> <div style="text-align: center;">  HIGH #1 </div> <div style="text-align: center;">  HIGH #2 </div> </div> <div style="display: flex; justify-content: space-around; align-items: center; margin-top: 20px;"> <div style="text-align: center;">  HIGH #3 </div> </div>	

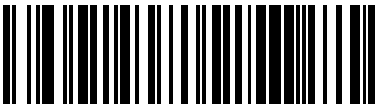
Cell Phone Detection Sensitivity — continued

START / END							
PROGRAMMING BARCODES							
<p style="text-align: center;">Cell Phone Detection Sensitivity = MEDIUM [This is the DEFAULT setting]</p> <table><tr><td data-bbox="267 525 649 630"></td><td data-bbox="1031 556 1177 588">MEDIUM #1</td></tr><tr><td data-bbox="389 714 535 745">MEDIUM #2</td><td data-bbox="909 682 1291 787"></td></tr><tr><td data-bbox="267 850 609 955"></td><td data-bbox="1031 871 1177 903">MEDIUM #3</td></tr></table>			MEDIUM #1	MEDIUM #2			MEDIUM #3
	MEDIUM #1						
MEDIUM #2							
	MEDIUM #3						
PROGRAMMING BARCODES							
<p style="text-align: center;">Cell Phone Detection Sensitivity = LOW</p> <table><tr><td data-bbox="267 1123 649 1228"></td><td data-bbox="1047 1155 1153 1186">LOW #1</td></tr><tr><td data-bbox="406 1312 511 1344">LOW #2</td><td data-bbox="917 1281 1291 1386"></td></tr><tr><td data-bbox="267 1438 609 1543"></td><td data-bbox="1047 1470 1153 1501">LOW #3</td></tr></table>			LOW #1	LOW #2			LOW #3
	LOW #1						
LOW #2							
	LOW #3						

Cell Phone in Target Mode

This feature sets the reader's Cell Phone Mode when it is in Target Mode:



This feature is only available when Cell Phone Mode is enabled.

NOTE



No Cell Phone Mode — Will not read cell phone labels when in Target Mode.

Auto Detection Cell Phone Mode — Automatically detects cell phone labels and shifts to Cell Phone Mode when in Target Mode.

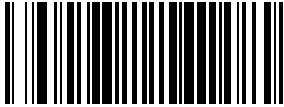
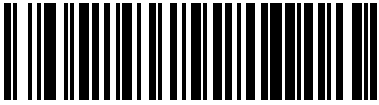

Always Enter Cell Phone Mode — The reader will always enter Cell Phone Mode whenever it is in Target Mode.

Follow these instructions to configure this feature:

1. Determine which mode is desired from the selections above.
2. Scan the START barcode to place the scanner in Programming Mode.
3. Scan the two barcodes which configure the desired mode.
4. Scan the END barcode.

START / END	
PROGRAMMING BARCODES	
<p>Cell Phone in Target Mode = No Cell Phone Mode [This is the DEFAULT setting]</p>	
	No Cell Phone Mode #1
No Cell Phone Mode #2	

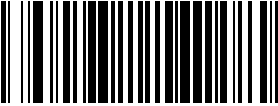
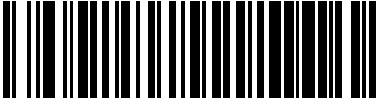
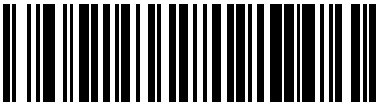
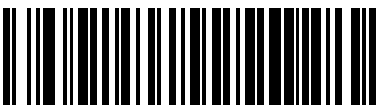
Cell Phone in Target Mode — continued

START / END	
PROGRAMMING BARCODES	
Cell Phone in Target Mode = Auto Detection Cell Phone Mode	
	Auto Detection Cell Phone Mode #1
Auto Detection Cell Phone Mode #2	
Cell Phone in Target Mode = Always Enter Cell Phone Mode	
	Always Enter Cell Phone Mode #1
Always Enter Cell Phone Mode #2	

Interface Related Features

At the time of this writing, the reader supports the interfaces listed in [Table 3-1](#). Select the desired interface type from the table, then reference the page number given for the customizable features section associated with each interface. See [Table 3-2](#) for a description of each Keyboard Wedge interface type (A through Y as listed).

Table 3-1. Interfaces Supported

Interface Type	Page	Keyboard Wedge	Page
RS-232		Keyboard Wedge	3-34
RS-232 Standard	3-33	Keyboard Wedge A ^a	3-34
RS-232 Wincor-Nixdorf	3-33	Keyboard Wedge B ^a	3-34
IBM		Keyboard Wedge C ^a	3-34
IBM 4683 Port 5B	3-33	Keyboard Wedge D ^a	3-34
IBM 4683 Port 9B	3-33	Keyboard Wedge E ^a	3-34
IBM 4683 Port 17	3-33	Keyboard Wedge F ^a	3-34
USB		Keyboard Wedge G ^a	3-34
USB-OEM	3-33	Keyboard Wedge H ^a	3-34
USB Keyboard	3-33	Keyboard Wedge I ^a	3-34
USB COM Interface	3-33	Keyboard Wedge J ^a	3-34

a. Consult [Table 3-2](#) for more information regarding keyboard interface types.



The correct interface cable is included for the reader interface type you ordered.

NOTE

Table 3-2. Keyboard Wedge Interface Reference

I/F Type	PCs Supported
A	PC/XT w/Alternate Key Encoding
B	AT, PS/2 25-286, 30-286, 50, 50Z, 60, 70, 80, 90 & 95 w/Alternate Key Encoding
C	PS/2 25 and 30 w/Alternate Key Encoding
D	PC/XT w/Standard Key Encoding
E	AT, PS/2 25-286, 30-286, 50, 50Z, 60, 70, 80, 90 & 95 w/Standard Key Encoding
F	PS/2 25 and 30 w/Standard Key Encoding
G	IBM 3xxx w/122 keyboard
H	IBM 3xxx w/102 keyboard
I	PS/55 5530T w/104 keyboard
J	NEC 9801

**NOTE**

Reference [Appendix E, Keyboard Function Key Mappings](#) for more information about keyboards.

Interface Selection

START / END	
PROGRAMMING BARCODES	
	RS-232 Standard
RS-232 Wincor-Nixdorf	
	IBM 4683 Port 5B
IBM 4683 Port 9B	
	IBM 4683 Port 17
USB-OEM	
	USB Keyboard
USB COM Interface	



Interface Selection – cont.

START / END	
PROGRAMMING BARCODES	
Keyboard Wedge A	
	Keyboard Wedge B
Keyboard Wedge C	
	Keyboard Wedge D
Keyboard Wedge E	
	Keyboard Wedge F
Keyboard Wedge G	
	Keyboard Wedge H
Keyboard Wedge I	
	Keyboard Wedge J

Interface Features

Obey/Ignore Host Commands

When set to ignore host commands, the scanner will ignore all host commands except for the minimum set necessary to keep the interface active and transmit labels. For normal operation of the interface, select Obey Host Commands.



START / END	
PROGRAMMING BARCODES	
	Obey Host Commands DEFAULT
Ignore Host Commands	

Interface Features – cont.





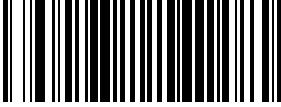

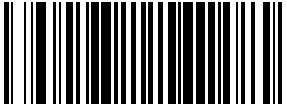

Host Transmission Buffers

Specifies the number of host transmission(s) that may be buffered. By buffering data from a barcode, the scanner can continue to read a new barcode while the old one is being transmitted to the host. Selecting **BUFFERS = 1** means that the first barcode must be transmitted before a new one can be read. A selection of **BUFFERS = 2** means that a new barcode can be read while data from the first barcode is transmitted.







When a **DISABLE SCANNER** command is received from the host, the scanner will continue to transmit all data that is buffered.

START / END	
PROGRAMMING BARCODES	
	Host Transmission Buffers = 1
Host Transmission Buffers = 2 DEFAULT	

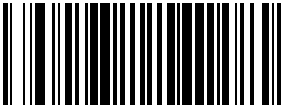
RS-232 Interface Features

START / END	
PROGRAMMING BARCODES	
	1200 Baud
2400 Baud	
	4800 Baud
9600 Baud DEFAULT	
	19200 Baud
38400 Baud	
	57600 Baud
115200 Baud	

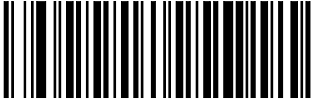
RS-232 Interface Features – cont.

START / END	
PROGRAMMING BARCODES	
	7 Data Bits
8 Data Bits DEFAULT	
	1 Stop Bit DEFAULT
2 Stop Bits	
	Parity = None DEFAULT
Parity = Even	
	Parity = Odd



RS-232 Interface Features — cont.

Hardware Flow Control

Disable Hardware Control— The scanner transmits to the host regardless of any activity on the CTS line.

Enable CTS Flow Control— The CTS signal controls transmission of data to the host.

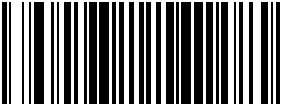
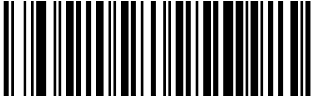





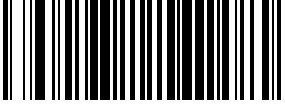

Enable CTS Scan Control— The CTS line must be active for the scanner to read and transmit data. While the CTS line is inactive, the scanner remains in a host-disabled state; following a successful label transmission, the CTS signal must transition to inactive and then to active to enable scanning for the next label.

START / END	
PROGRAMMING BARCODES	
	Disable Hardware Control DEFAULT
Enable CTS Flow Control	
	Enable CTS Scan Control

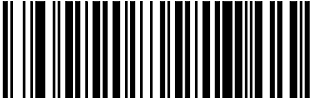

RS-232 Interface Features – cont.

Intercharacter Delay

This delay is inserted after each data character transmitted. If the transmission speed is too high, the system may not be able to receive all characters. You may need to adjust the delay to make the system work properly.

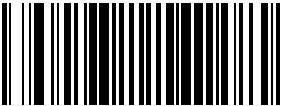

START / END	
PROGRAMMING BARCODES	
	Inter-Char Delay = No Delay DEFAULT
Interchar Delay = 10 msec	
	Interchar Delay = 20 msec
Interchar Delay = 30 msec	
	Interchar Delay = 40 msec
Interchar Delay = 50 msec	
	Interchar Delay = 60 msec
Interchar Delay = 70 msec	

Intercharacter Delay – cont.

START / END	
PROGRAMMING BARCODES	
	Interchar Delay = 80 msec
Interchar Delay = 90 msec	

Software Flow Control

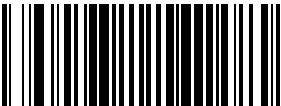
Disables/Enables software control using XON/XOFF characters.

START / END	
PROGRAMMING BARCODES	
	Disable Software Flow Control DEFAULT
Enable Software Flow Control	





RS-232 Interface Features – cont.

Host Echo Quiet Interval

This setting specifies the time interval of RS-232 channel inactivity which must transpire before the scanner will break the host echo loop to transmit the barcode data that has just been scanned to the host.

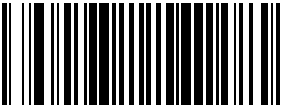
START / END	
PROGRAMMING BARCODES	
	Host Echo Quiet Interval = 0msec
Host Echo Quiet Interval = 10msec DEFAULT	
	Host Echo Quiet Interval = 20msec
Host Echo Quiet Interval = 30msec	
	Host Echo Quiet Interval = 40msec
Host Echo Quiet Interval = 50msec	
	Host Echo Quiet Interval = 60msec
Host Echo Quiet Interval = 70msec	

Host Echo Quiet Interval – cont.

START / END	
PROGRAMMING BARCODES	
	Host Echo Quiet Interval = 80msec
Host Echo Quiet Interval = 90msec	
	Host Echo Quiet Interval = 100msec

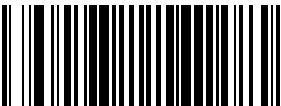
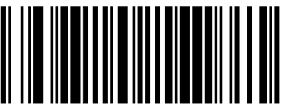
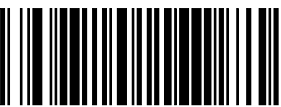

Signal Voltage: Normal/TTL

Specifies whether the RS-232 interface provides TTL levels on the output pins TxD and RTS.

START / END	
PROGRAMMING BARCODES	
	Signal Voltage: Normal RS-232 DEFAULT
Signal Voltage: TTL	

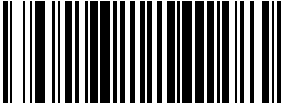

Beep on ASCII BEL

Enables/disables ability of scanner to beep (sound a good read tone) on receiving an ASCII BEL (07 hex).

START / END	
PROGRAMMING BARCODES	
	Disable Beep on ASCII BEL DEFAULT
Enable Beep on ASCII BEL	

Beep on Not on File





Select for the host to beep (or not) when a not-on-file (host command) condition is detected by the host.

START / END	
PROGRAMMING BARCODES	
	Disable Beep on Not On File
Enable Beep on Not On File DEFAULT	

ACK NAK Options

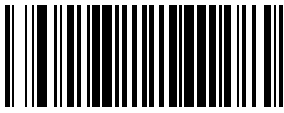

This enables/disables the ability of the scanner to support the RS-232 ACK/NAK protocol. When configured, the scanner and/or host sends an “ACK” when it receives data properly, and sends “NAK” when the data is in error. Selections for this option are:

- Disable
- Enable for label transmission — the scanner expects an ACK/NAK response from the host when a label is sent
- Enable for host-command acknowledge — the scanner will respond with ACK/NAK when the host sends a command
- Enable for label transmission and host-command acknowledge

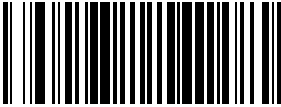

START / END	
PROGRAMMING BARCODES	
	Disable ACK NAK DEFAULT
Enable ACK NAK for Transmission	
	Enable ACK NAK for host command acknowledge
Enable ACK NAK for transmission and host command	

RS-232 Interface Features – cont. – cont.

ACK Character

START / END	
PROGRAMMING BARCODES	
<p>Sets the ACK character from the set of ASCII characters or any decimal value from 000 to 255. Pad entries of less than three digits with zeros, as in “005”. To configure this feature, scan the “START/END” barcode above to place the unit in Programming Mode, then the “Set ACK Character,” followed by the digits from the Alphanumeric table in Appendix C, Alpha-Numeric Pad representing your desired character. Exit programming mode by again scanning the “START/END” barcode above.</p> <p style="text-align: center;">DEFAULT SETTING FOR THIS FEATURE: 006</p>	
	Set ACK Character

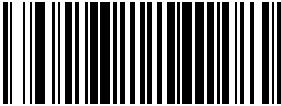

NAK Character

START / END	
PROGRAMMING BARCODES	
<p>Sets the NAK character from the set of ASCII characters or any decimal value from 000 to 255. Pad entries of less than three digits with zeros, as in “005”. To configure this feature, scan the “START/END” barcode above to place the unit in Programming Mode, then the “Set NAK Character,” followed by the digits from the Alphanumeric table in Appendix C, Alpha-Numeric Pad representing your desired character. Exit programming mode by again scanning the “START/END” barcode above.</p> <p style="text-align: center;">DEFAULT SETTING FOR THIS FEATURE: 021</p>	
	Set NAK Character

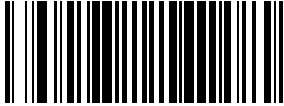

RS-232 Interface Features — cont.

Retry on ACK NAK Timeout

Enables/disables retry after the configurable ACK NAK Timeout Value (set in the following feature) has expired.

START / END	
PROGRAMMING BARCODES	
	Disable Retry on ACK NAK Timeout
Enable Retry on ACK NAK Timeout DEFAULT	

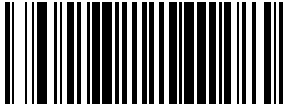
ACK NAK Timeout Value

START / END	
PROGRAMMING BARCODES	
<p>This item specifies the time the scanner will wait for an ACK character from the host following a label transmission.</p> <p>000 = Infinite timeout 001 - 075 = Timeout in 200-millisecond increments</p> <p>To configure this feature, scan the “START/END” barcode above to place the unit in Programming Mode, then the “Set ACK NAK Timeout Value,” followed by the three digits (zero padded) from the Alphanumeric table in Appendix C, Alpha-Numeric Pad representing your desired value. Exit programming mode by again scanning the “START/END” barcode above.</p> <p style="text-align: center;">DEFAULT SETTING FOR THIS FEATURE: 001 (200 msec)</p>	
	Set ACK NAK Timeout Value

RS-232 Interface Features – cont.

ACK NAK Retry Count

START / END



PROGRAMMING BARCODES

This feature sets the number of times for the scanner to retry a label transmission under a retry condition.

000 = No retry

001 - 254 = Retry for the specified number of times

255 = Retry forever

To configure this feature, scan the “START/END” barcode above to place the unit in Programming Mode, then the “Set ACK NAK Retry Count,” followed by the three digits (zero padded) from the Alphanumeric table in [Appendix C, Alpha-Numeric Pad](#) representing your desired retry count. Exit programming mode by again scanning the “START/END” barcode above

DEFAULT SETTING FOR THIS FEATURE: 003



Set ACK NAK Timeout Value

RS-232 Interface Features — cont.





ACK NAK Error Handling

This item specifies the method the scanner will use to handle errors detected while waiting to receive the ACK character from the host. Errors include unrecognized host commands and communication errors such as parity or framing errors. Choices are:

00 = Ignore errors detected (recommended setting)

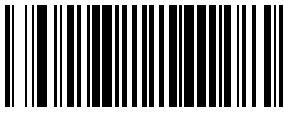
01 = Process error as valid ACK character (risk of lost label data)



02 = Process error as valid NAK character (risk of duplicate label data)

START / END	
PROGRAMMING BARCODES	
	Ignore Errors Detected DEFAULT
Process error as valid ACK character	
	Process error as valid NAK character

RS-232 Interface Features – cont.

Transmission Failure Indication

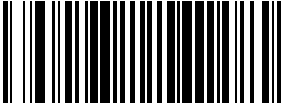
Enables/disables bad-label indication upon transmission failure.



START / END	
PROGRAMMING BARCODES	
	Disable Transmission Error Indication
Enable Transmission Error Indication DEFAULT	

USB-OEM Interface Features

USB-OEM Device usage

The USB-OEM protocol allows for the scanner to be identified as one of two different types of barcode scanners. Depending on what other scanners you may already have connected to a USB-OEM POS, you may need to change this setting to enable all devices to communicate. Options are:

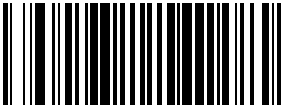

- Table Top Scanner
- Handheld Scanner

START / END	
PROGRAMMING BARCODES	
	Configure as Table Top Scanner DEFAULT
Configure as Handheld Scanner	

IBM

IBM Transmit Labels in Code 39 Format

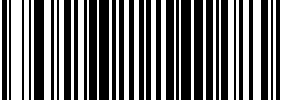
This feature enables/disables scanner's ability to set a symbology identifier for a specified label to Code 39 before transmitting that label data to an IBM host. This applies to: Code 128, Codabar and Code 93 for USB-OEM; Code 128, Codabar and Code 93 for IBM Port 5B; and Codabar and Code 93 for IBM Port 9B.

START / END	
PROGRAMMING BARCODES	
	Disable Convert to Code 39 DEFAULT
Enable Convert to Code 39	

Keyboard Wedge and USB Keyboard

As a keyboard interface, the scanner supports most popular PCs and IBM terminals. The installation of the wedge is a fairly simple process that doesn't require any changes of software or hardware.



NOTE

All of the options in this section apply to the Keyboard Wedge, however, only some apply to USB Keyboard.

Keyboard Layout

The Keyboard Layout option supports many countries. For details about Keyboard Layout, please refer to your operating system manual.

START / END	
PROGRAMMING BARCODES	
	USA DEFAULT
Belgium	
	Britain
Denmark	
	France
Germany	

Keyboard Wedge – cont.



START / END	
PROGRAMMING BARCODES	
	Italy
Norway	
	Portugal
Spain	
	Sweden
Switzerland	
	Japan 106 Key
Hungary	
	Czech Republic

Keyboard Wedge – cont.

START / END		
PROGRAMMING BARCODES		
	Slovakia	
Romania		
	Croatia	
Poland		

Caps Lock State

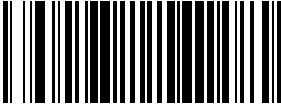
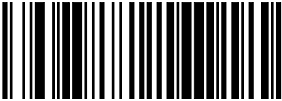
Specifies the format in which the scanner sends character data.

START / END		
PROGRAMMING BARCODES		
	Disable Caps Lock DEFAULT	
Caps Lock “ON”		
	Shift Lock “ON”	

Keyboard Wedge – cont.



Power-On Simulation



This feature does not apply to the USB Keyboard interface.

NOTE

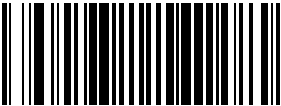

All PCs check the keyboard status during the power-on Selftest. It is recommended that you enable this function if you are working without a keyboard installation. It simulates keyboard timing and passes the keyboard status to the PC during power-on.

START / END	
PROGRAMMING BARCODES	
	Disable Power-on Simulation DEFAULT
Enable Power-on Simulation	

Control Characters

Specifies how the scanner transmits ASCII control characters to the host. Choices are:

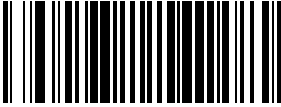
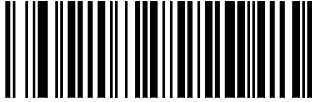
- Disable Control Characters
- Enable transmission of control characters to host
- Send characters between 00H and 1FH according to a special function-key mapping table. (This is used to send keys that are not in the normal ASCII set; a unique set is provided for each available scancode set. Reference [Appendix E, Keyboard Function Key Mappings.](#))

START / END	
PROGRAMMING BARCODES	
	Disable Control Characters DEFAULT
Enable Transmission of Control Characters	
	Enable Function Key Mapping

Keyboard Wedge – cont.



Wedge Quiet Interval



NOTE



This feature does not apply to the USB Keyboard interface.

Quiet Interval is the amount of time to look for keyboard activity before the scanner breaks the keyboard connection in order to transmit data to the host.

START / END	
PROGRAMMING BARCODES	
<p>Selectable from 001 to 100 in 10 msec increments. To configure this feature, scan the “START/END” bar code above to place the unit in Programming Mode, then the Set Wedge Quiet Interval bar code followed by the three digits (zero padded) from the Alphanumeric table in Appendix C, Alpha-Numeric Pad representing your desired length. Exit programming mode by again scanning the “START/END” bar code above.</p> <p style="text-align: center;">DEFAULT SETTING FOR THIS FEATURE: 010 (100 msec)</p>	
	Set Wedge Quiet Interval

Keyboard Wedge – cont.

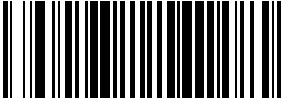
Intercharacter Delay

START / END	
PROGRAMMING BARCODES	
<p>One-half of the delay specified below is inserted between scancodes within each character. If the transmission speed is too high, the system may not be able to receive all characters. You may need to adjust the delay to make the system work properly. Selectable from 00 to 99 in 10msec increments.</p> <p>To configure this feature, scan the “START/END” barcode above to place the unit in Programming Mode, then the “Set Intercharacter Delay,” followed by the three digits (zero padded) from the Alphanumeric table in Appendix C, Alpha-Numeric Pad representing your desired length. Exit programming mode by again scanning the “START/END” barcode above/</p>	
<p>DEFAULT SETTING FOR THIS FEATURE: 00 (No Delay)</p>	
	Set Intercharacter Delay

USB COM Interface Set-up

This interface uses the Microsoft Windows USB COM driver. Before plugging your reader into the host PC, please ensure you have already copied the DLS_EUG_CDC_ACM.inf file provided by Datalogic to your PC and the reader’s interface is set to USB COM.

1. When you first plug the scanner into the PC, Windows will bring up the “Found New Hardware Wizard.” Select “Install from a list” and click on “Next.”
2. Click on “Include this location in the search” and enter the path where the file DLS_EUG_CDC_ACM.inf file is stored. Click on “Next.”
3. If a message appears that says the software has not passed Windows logo testing, press “Continue” anyway.
4. Click on “Finish.”
5. Once the install is complete, reboot the PC.

Chapter 4

Data Editing

Data Editing Overview



CAUTION

It is not recommended to use these features with IBM interfaces.

When a barcode is scanned, additional information can be sent to the host computer along with the barcode data. This combination of barcode data and supplementary user-defined data is called a “message string.” The features in this chapter can be used to build specific user-defined data into a message string.

There are several types of selectable data characters that can be sent before and after scanned data. You can specify if they should be sent with all symbologies, or only with specific symbologies. [Figure 4-1](#) shows the available elements you can add to a message string:

Figure 4-1. Breakdown of a Message String

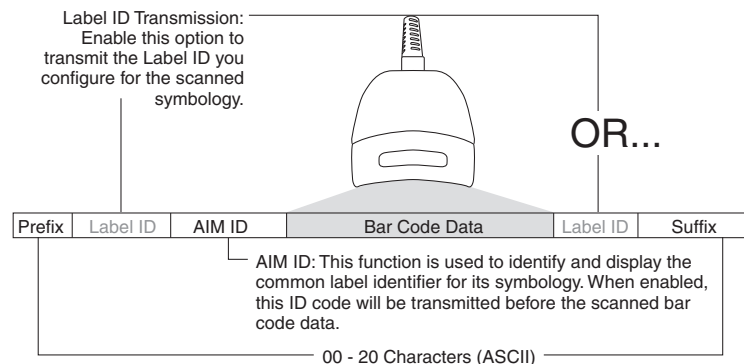

Please Keep In Mind...

- Modifying a message string is not a mandatory requirement. Data editing is sophisticated feature allowing highly customizable output for advanced users. Factory default settings for data editing is typically set to NONE.
- A prefix or suffix may be applied (reference the [Symbologies](#) chapter for these settings) across all symbologies (set via the Global features in this chapter).
- You can add any character from the [ASCII Chart](#) (from 00-7F) on the inside back cover of this manual as a prefix, suffix or Label ID.
- Enter prefixes and suffixes in the order in which you want them to appear on the output.

Global Prefix/Suffix

Up to 20 ASCII characters may be added as a prefix (in a position before the barcode data) and/or as a suffix (in a position following the barcode data) as indicated in [Figure 4-2](#).

Figure 4-2. Prefix and Suffix Positions

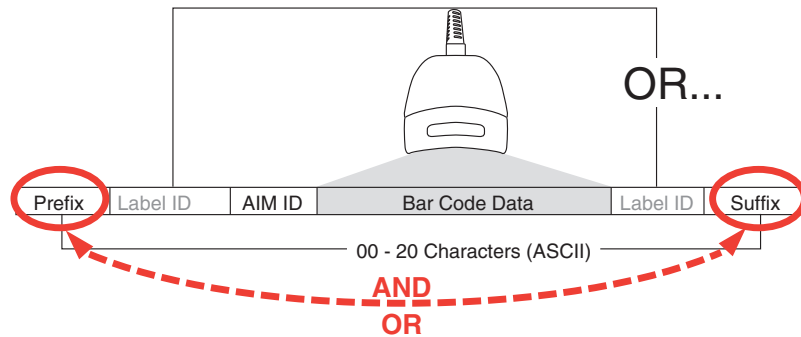

Example: Setting a Prefix

In this example, we'll set a prefix for all symbologies.

1. Determine which ASCII character(s) are to be added to scanned barcode data. In this example, we'll add a dollar sign ('\$') as a prefix.
2. Scan the START barcode.
3. Scan the SET PREFIX barcode.
4. Reference the [ASCII Chart](#) on the inside back cover of this manual, to find the hex value assigned to the desired character. The corresponding hex number for the '\$' character is 24. To enter this selection code, scan the '2' and '4' barcodes from [Appendix C, Alpha-Numeric Pad](#).
5. Scan the END barcode once to finish the string, then scan END again to exit Programming Mode.



If all 20 characters will be used in the prefix or suffix, do not scan the END barcode to finish the string. It is done automatically.



NOTE

6. The resulting message string would appear as follows:

Scanned barcode data:12345

Resulting message string output: \$12345

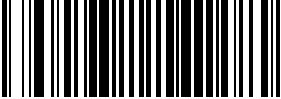
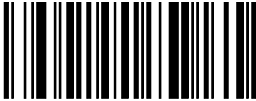
Global Prefix/Suffix – cont.

START / END	
PROGRAMMING BARCODES	
<p>Sets up to 20 characters each from the set of ASCII characters or any hex value from 00 to 7F. To configure this feature, scan the “START/END” barcode above to place the unit in Programming Mode, then the “Set Prefix” or “Set Suffix,” followed by the digits from the Alphanumeric table in Appendix C, Alpha-Numeric Pad representing your desired character(s). Reference the section, "Example: Setting a Prefix", for more information. Exit programming mode by scanning the “START/END” barcode again (scan “START/END” twice if less than 20 characters have been selected).</p> <p style="text-align: center;">DEFAULT SETTING PREFIX: 00 (None) DEFAULT SETTING SUFFIX: 0D (CR)</p>	
	Set Prefix
Set Suffix	

AIM ID

AIM (Automatic Identification Manufacturers) label identifiers are assigned from a globally standardized list — as opposed to custom label ID characters you select yourself — and can be included with scanned barcode data. AIM label identifiers consist of three characters as follows:



- A close brace character (ASCII ‘]’), followed by...
- A code character (see the table below), followed by...
- A modifier character (the modifier character is symbol dependent)

SYMBOLGY	CHA R	SYMBOLGY	CHA R
UPC/EAN	E	Code 128/EAN 128	C
Code 39	A	MSI/Plessey	M
Codabar	F	RSS (GS1 Omnidirectional, GS1 Expanded)	e
Interleaved 2 of 5	I	Standard 2 of 5	S
Code 93	G	ISBN	X ^a

a. ISBN (X with a 0 modifier character)

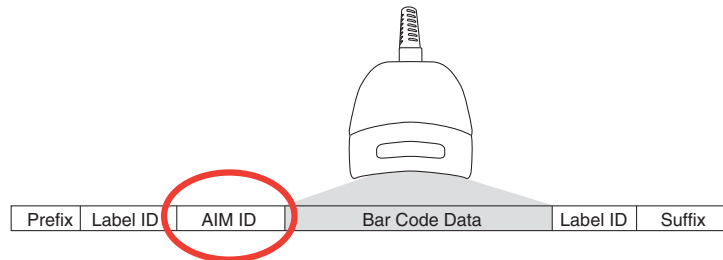
Figure 4-3. AIM ID

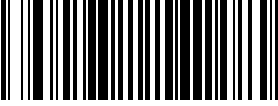

START / END	
PROGRAMMING BARCODES	
	Disable AIM ID DEFAULT
Enable AIM ID	

Label ID

A Label ID is used to identify a barcode (symbology) type. See [Appendix D, Default Settings](#), for a listing for common symbologies. It can be appended previous to or following the transmitted barcode data depending upon how this option is enabled. This feature provides options for configuring custom Label IDs individually per symbology. If you wish to program the scanner to always include an industry standard label identifier for ALL symbology types, see the previous feature, [AIM ID](#).

The Label ID is a customizable code of up to three ASCII characters (each of which are 00-7F) followed by a control character (00-01). This control character, when set to zero, does nothing. When set to one, it appends the symbology's AIM ID to the Label ID.



NOTE

When the control character is set to 01 for UPC-A and UPC-E, it expands the label to EAN-13 and thus follows the EAN-13 Label ID settings.



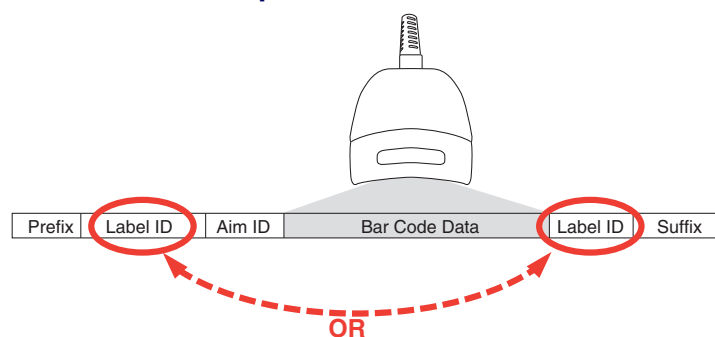

To configure a Label ID:

1. Scan the START barcode.
2. Select Label ID position as either BEFORE or AFTER by scanning the appropriate barcode.
3. Scan a barcode to select the symbology for which you wish to configure a custom Label ID.
4. Determine the desired character(s) (you may choose up to three) which will represent the Label ID for the selected symbology. Next, turn to the [ASCII Chart](#) on the inside back cover of this manual and find the equivalent hex digits associated with your choice of Label ID. For example, if you wish to select an equal sign (=) as a Label ID, the chart indicates its associated hex characters as 3D.
5. Turn to [Appendix C, Alpha-Numeric Pad](#) and scan the barcodes representing the hex characters determined in the previous step. For example, to make an equal sign (=), scan '3' and 'D' followed by '0' six times. Since this is a three-character buffer, '00' is scanned for character two, '00' for character three and '00' for the control character. ('00' indicates no character.)
6. Scan the END barcode to exit programming mode.

Figure 4-4. Label ID Position Options

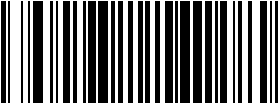

Label ID – cont.

START / END	
PROGRAMMING BARCODES	
	Label ID Transmission: Disable
Label ID Position: Before Barcode Data DEFAULT	
	Label ID Position: After Barcode Data
Set UPC-A Label ID Character(s)	 DEFAULT SETTING FOR THIS FEATURE: A (41 hex)
 DEFAULT SETTING FOR THIS FEATURE: A (41 hex)	Set UPC-A w/P2 Addon Label ID Character(s)
Set UPC-A w/P5 Addon Label ID Character(s)	 DEFAULT SETTING FOR THIS FEATURE: A (41 hex)
 DEFAULT SETTING FOR THIS FEATURE: A (41 hex)	Set UPC-A w/C128 Addon Label ID Character(s)
Set UPC-E Label ID Character(s)	 DEFAULT SETTING FOR THIS FEATURE: E (45 hex)

Label ID – cont.

START / END	
PROGRAMMING BARCODES	
 DEFAULT SETTING FOR THIS FEATURE: E (45 hex)	Set UPC-E w/P2 Addon Label ID Character(s)
Set UPC-E w/P5 Addon Label ID Character(s)	 DEFAULT SETTING FOR THIS FEATURE: E (45 hex)
 DEFAULT SETTING FOR THIS FEATURE: E (45 hex)	Set UPC-E w/C128 Addon Label ID Character(s)
Set EAN-8 Label ID Character(s)	 DEFAULT SETTING FOR THIS FEATURE: FF (4646 hex)
 DEFAULT SETTING FOR THIS FEATURE: FF (4646 hex)	Set EAN-8 w/P2 Addon Label ID Character(s)
Set EAN-8 w/P5 Addon Label ID Character(s)	 DEFAULT SETTING FOR THIS FEATURE: FF (4646 hex)
 DEFAULT SETTING FOR THIS FEATURE: FF (4646 hex)	Set EAN-8 w/C128 Addon Label ID Character(s)
Set EAN-13 Label ID Character(s)	 DEFAULT SETTING FOR THIS FEATURE: F (46 hex)







Label ID – cont.

START / END	
PROGRAMMING BARCODES	
 DEFAULT SETTING FOR THIS FEATURE: F (46 hex)	Set EAN-13 w/P2 Addon Label ID Character(s)
Set EAN-13 w/P5 Addon Label ID Character(s)	 DEFAULT SETTING FOR THIS FEATURE: F (46 hex)
 DEFAULT SETTING FOR THIS FEATURE: F (46 hex)	Set EAN-13 w/C128 Addon Label ID Character(s)
Set ISBN Label ID Character(s)	 DEFAULT SETTING FOR THIS FEATURE: I (49 hex)
 DEFAULT SETTING FOR THIS FEATURE: IA (4941 hex)	Set IATA Label ID Character(s)
Set GTIN Label ID Character(s)	 DEFAULT SETTING FOR THIS FEATURE: G (47 hex)
 DEFAULT SETTING FOR THIS FEATURE: G2 (4732 hex)	Set GTIN w/P2 addon Label ID Character(s)
Set GTIN w/P5 addon Label ID Character(s)	 DEFAULT SETTING FOR THIS FEATURE: G5 (4735 hex)

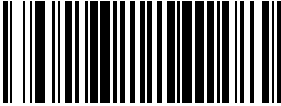
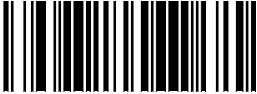
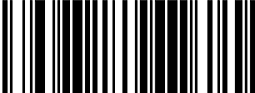
Label ID – cont.

START / END	
PROGRAMMING BARCODES	
 DEFAULT SETTING FOR THIS FEATURE: G8 (4738 hex)	Set GTIN w/C128 addon Label ID Character(s)
Set GS1 Omnidirectional Label ID Character(s)	 DEFAULT SETTING FOR THIS FEATURE: R4 (5234 hex)
 DEFAULT SETTING FOR THIS FEATURE: RX (5258 hex)	Set GS1 Expanded Label ID Character(s)
Set Code GS1 DataBar Limited Label ID Character(s)	 DEFAULT SETTING FOR THIS FEATURE: * (524C0000 hex)
 DEFAULT SETTING FOR THIS FEATURE: * (2A hex)	Set Code 39 Label ID Character(s)
Set Pharmacode 39 Label ID Character(s)	 DEFAULT SETTING FOR THIS FEATURE: A (41 hex)
 DEFAULT SETTING FOR THIS FEATURE: # (23 hex)	Set Code 128 Label ID Character(s)
Set I 2 of 5 Label ID Character(s)	 DEFAULT SETTING FOR THIS FEATURE: i (69 hex)

Label ID – cont.

START / END	
PROGRAMMING BARCODES	
 DEFAULT SETTING FOR THIS FEATURE: % (25 hex)	Set Codabar Label ID Character(s)
Set Code 93 Label ID Character(s)	 DEFAULT SETTING FOR THIS FEATURE: & (26 hex)
 DEFAULT SETTING FOR THIS FEATURE: @ (40 hex)	Set Code 11 Label ID Character(s)
Set MSI/Plessey Label ID Character(s)	 DEFAULT SETTING FOR THIS FEATURE: @ (40 hex)
 DEFAULT SETTING FOR THIS FEATURE: s (73 hex)	Set Std 2 of 5 Label ID Character(s)
Set EAN UCC Composite Label ID Character(s)	 DEFAULT SETTING FOR THIS FEATURE: 0
 DEFAULT SETTING FOR THIS FEATURE: P (5000 hex) ^a	Set PDF 417 Label ID Character(s)
Set Datamatrix Label ID Character(s)	 DEFAULT SETTING FOR THIS FEATURE: Dm (446D hex)

^a. Default setting exceptions for PDF 417 Label ID are as follows: Default for RS-232 WN is 'Q' (0x5100). Default for USB-HID-POS is 'P' (0x5020), or 'P-Space'.

Label ID – cont.



NOTE

For the 2D symbologies on this page, the Label ID is 4 bytes. The first 3 bytes are characters for the label ID. A 00 (hex) value in the first 3 bytes indicates the end of the label ID characters. The 4th byte is a control byte.

The use of the control byte is as follows:
bit 0-if set to 1, the AIM Id is appended for that label type

START / END	
PROGRAMMING BARCODES	
 DEFAULT SETTING FOR THIS FEATURE: mP (6D500000 hex)	Set Micro PDF 417 Label ID Character(s)
Set QR Code Label ID Character(s)	 DEFAULT SETTING FOR THIS FEATURE: QR (51520000 hex)
 DEFAULT SETTING FOR THIS FEATURE: MC (4D430000 hex)	Set Maxicode Label ID Character(s)
Set Aztec Label ID Character(s)	 DEFAULT SETTING FOR THIS FEATURE: Az (417A0000 hex)
 DEFAULT SETTING FOR THIS FEATURE: R4 (52340000 hex)	Set GS1 DataBar Omnidirectional 2D Composite Label ID Character(s)
Set GS1 DataBar Limited 2D Composite Label ID Character(s)	 DEFAULT SETTING FOR THIS FEATURE: RL (524C0000 hex)
 DEFAULT SETTING FOR THIS FEATURE: RX (52340000 hex)	Set GS1 DataBar Expanded 2D Composite Label ID Character(s)





Case Conversion

This feature can convert scanned barcode data to either all lower case (a through z) or all upper case (A through Z) characters.

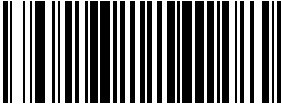

NOTE

Case conversion affects ONLY scanned barcode data, and does not affect Label ID, Prefix, Suffix, or other appended data.

START / END	
PROGRAMMING BARCODES	
	Disable DEFAULT
Convert to Upper Case	
	Convert to Lower Case

Character Conversion

Character conversion is an eight byte configuration item. The eight bytes are 4 character pairs represented in hexadecimal ASCII values. The first character in the pair is the character that will be converted. The second character in the pair is the character to convert to. If the character to convert in a pair is **FF**, then no conversion is done.

For example, if you have the character conversion configuration item set to the following:

41423132FFFFFFF

The first pair is **4142** or AB (**41** hex is an ASCII capital A, **42** hex is an ASCII capital B) and the second pair is **3132** or 12 (**31** hex is an ASCII 1, **32** is an ASCII 2). The other two pairs are **FFFF** and **FFFF**.

With the label, AG15TA81, it would look as follows after the character conversion:
BG25TB82.

The A characters were converted to the B character and the 1 characters were converted to the numeral 2 character. Nothing is done with the last two character pairs, since they are all **FF**.

To set Character Conversion:



1. Scan the START/END barcode.
2. Scan the Character Conversion barcode.
3. Determine the desired string. Up to sixteen positions can be determined as in the above example. Next, turn to the [ASCII Chart](#) on the inside back cover of this manual and find the equivalent hex digits needed to fulfill the string.



The positions not used must be filled with the character 'F'.

NOTE

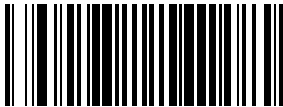
4. Turn to [Appendix C, Alpha-Numeric Pad](#) and scan the barcodes representing the hex characters determined in the previous step. When the last character is scanned, the scanner will sound a triple beep.
5. Scan the START/END barcode to exit Programming Mode.

START / END	
PROGRAMMING BARCODES	
	Character Conversion
DEFAULT SETTING FOR THIS FEATURE: FFFFFFFFFFFFFF hex (no conversion)	

NOTES

Chapter 5

Symbologies

The scanner supports the following symbologies (barcode types). Options for each symbology are included in this chapter.



- UPC-A
- UPC-E
- EAN-13
- EAN-8
- GS1 DataBar Omnidirectional / Stacked Omnidirectional
- GS1 DataBar Expanded / Expanded Stacked
- GS1 DataBar Limited
- Code 39
- Code 32 Italian Pharmacode
- Code 128
- Interleaved 2 of 5
- Codabar
- Code 93
- MSI/Plessey
- Standard 2 of 5

Factory Defaults— for the standard RS-232 interface are indicated in bold text throughout this section. Reference [Appendix D, Default Settings](#) for default exceptions for your interface.

UPC-A

Disable/Enable UPC-A

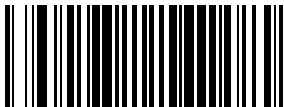

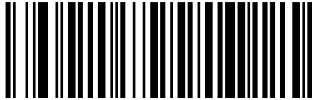
When disabled, the scanner will not read UPC-A barcodes.

START / END	
PROGRAMMING BARCODES	
	Disable UPC-A
Enable UPC-A DEFAULT	

UPC-A — continued



Check Digit Transmission

Enable this option to transmit the check digit along with UPC-A barcode data.

START / END	
PROGRAMMING BARCODES	
	Don't Send Check Digit
Send Check Digit DEFAULT	

Expand UPC-A to EAN-13

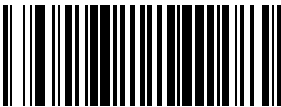

Expands UPC-A data to the EAN-13 data format. Selecting this feature also changes the symbology ID to match those required for EAN-13.

START / END	
PROGRAMMING BARCODES	
	Don't Expand to EAN-13 DEFAULT
Expand to EAN-13	

UPC-A — continued



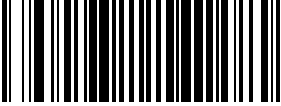

Number System Transmission

This feature enables/disables transmission of UPC-A System Number.

START / END	
PROGRAMMING BARCODES	
	Disable Number System Transmission
Enable Number System Transmission DEFAULT	

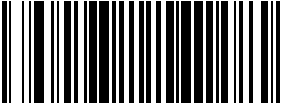
UPC-A Minimum Reads

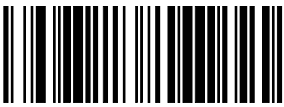



This feature specifies the minimum number of consecutive times a UPC-A label must be decoded before it is accepted as good read.

START / END	
PROGRAMMING BARCODES	
	Minimum = 1 Read DEFAULT
Minimum = 2 Reads	
	Minimum = 3 Reads
Minimum = 4 Reads	

UPC-A — continued

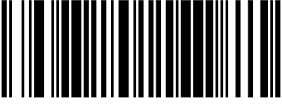
UPC-A In-store Minimum Reads

This feature specifies the minimum number of consecutive times an in-store printed label must be decoded before it is accepted as good read.



START / END	
PROGRAMMING BARCODES	
	Minimum = 1 Read DEFAULT
Minimum = 2 Reads	
	Minimum = 3 Reads
Minimum = 4 Reads	

UPC-E

The following options apply to the UPC-E symbology.

Disable/Enable UPC-E

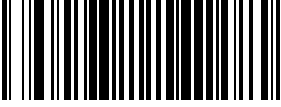
When disabled, the scanner will not read UPC-E barcodes.

START / END	
PROGRAMMING BARCODES	
	Disable UPC-E
Enable UPC-E DEFAULT	

Check Digit Transmission



Enable this option to transmit the check digit along with UPC-E barcode data.

START / END	
PROGRAMMING BARCODES	
	Don't Send Check Digit
Send Check Digit DEFAULT	

UPC-E — continued

Number System Digit

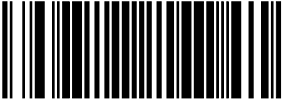
The Number System Digit (NSD) which is always a zero (0) in the leading position can be optionally included (or not) with scanned barcode data.

START / END	
PROGRAMMING BARCODES	
	Exclude Number System Digit DEFAULT
Include Number System Digit	

Expand to UPC-E to UPC-A

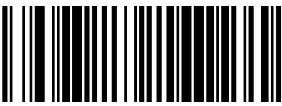
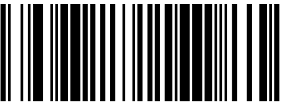

Enables/disables expansion of UPC-E labels to UPC-A. Selecting this feature also changes the symbology ID to match those required for UPC-A.

START / END	
PROGRAMMING BARCODES	
	Don't Expand UPC-E to UPC-A DEFAULT
Expand UPC-E to UPC-A	

UPC-E — continued



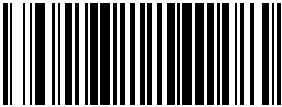

Expand UPC-E to EAN13

Enables/disables expansion of UPC-E labels to EAN-13. Selecting this feature also changes the symbology ID to match those required for EAN-13.

START / END	
PROGRAMMING BARCODES	
	Don't Expand UPC-E to EAN-13 DEFAULT
Expand UPC-E to EAN-13	

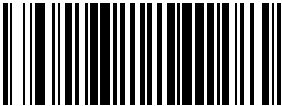
Minimum Reads

This feature specifies the minimum number of consecutive times a UPC-E label must be decoded before it is accepted as good read.



START / END	
PROGRAMMING BARCODES	
	Minimum = 1 Read
Minimum = 2 Reads DEFAULT	
	Minimum = 3 Reads
Minimum = 4 Reads	

GTIN

The following options apply to the GTIN label data format.

Expand UPC/EAN to GTIN

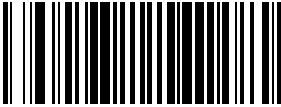
When this feature is enabled, the scanner will translate UPC/EAN labels to the 14 digit GTIN format.



START / END	
PROGRAMMING BARCODES	
	Don't Expand to GTIN DEFAULT
Expand to GTIN	

EAN-13

The following options apply to the EAN-13 symbology.

Disable/Enable EAN-13

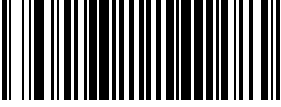
When disabled, the scanner will not read EAN-13 barcodes.

START / END	
PROGRAMMING BARCODES	
	Disable EAN-13
Enable EAN-13 DEFAULT	

Check Digit Transmission



Enable this option to transmit the check digit along with EAN-13 barcode data.

START / END	
PROGRAMMING BARCODES	
	Don't Send Check Digit
Send Check Digit DEFAULT	

EAN-13 — continued

EAN-13 Flag 1 Character

Enables/disables transmission of an EAN/JAN13 Flag1 character.

START / END	
PROGRAMMING BARCODES	
	Don't Transmit EAN-13 Flag 1 Char
Transmit EAN-13 Flag 1 Char DEFAULT	

ISBN

When enabled, this feature truncates the leading three digits from labels that contain ISBN (International Standard Book Number) and appends an ISBN check character to the end of the label. These codes are used for books and magazines. Labels with ISBN codes start with "978".

Example:

Barcode data: "9789572222720"



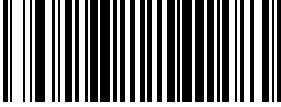

Output: "9572222724"

START / END	
PROGRAMMING BARCODES	
	Disable ISBN DEFAULT
Enable ISBN	

EAN-13 — continued

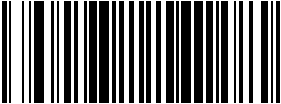
Minimum Reads

This feature specifies the minimum number of consecutive times an EAN-13 label must be decoded before it is accepted as good read.



START / END	
PROGRAMMING BARCODES	
	Minimum = 1 Read DEFAULT
Minimum = 2 Reads	
	Minimum = 3 Reads
Minimum = 4 Reads	

EAN-8

The following options apply to the EAN-8 symbology.

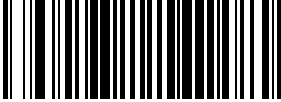

Disable/Enable EAN-8

When disabled, the scanner will not read EAN-8 barcodes.

START / END	
PROGRAMMING BARCODES	
	Disable EAN-8
Enable EAN-8 DEFAULT	

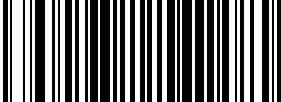

Check Digit Transmission

Enable this option to transmit the check Digit along with EAN-8 barcode data.

START / END	
PROGRAMMING BARCODES	
	Don't Send Check Digit
Send Check Digit DEFAULT	



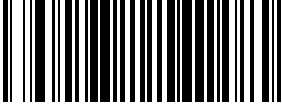

EAN-8 — continued

Expand EAN-8 to EAN-13— Expands EAN-8 data to the EAN-13 data format. Selecting this feature also changes the symbology ID to match those required for EAN-13.

START / END	
PROGRAMMING BARCODES	
	Don't Expand to EAN-13 DEFAULT
Expand to EAN-13	

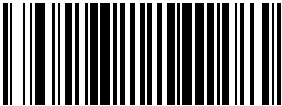
Minimum Reads

This feature specifies the minimum number of consecutive times an EAN-8 label must be decoded before it is accepted as good read.

START / END	
PROGRAMMING BARCODES	
	Minimum = 1 Read DEFAULT
Minimum = 2 Reads	
	Minimum = 3 Reads
Minimum = 4 Reads	

EAN Two-Label





Enables/disables the ability of the scanner to decode EAN two-label pairs.

START / END	
PROGRAMMING BARCODES	
	Disable EAN Two-Label
Enable EAN Two-Label	

EAN Two-Label Type 1

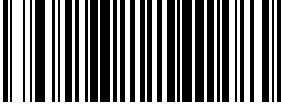
Specifies label types and number of flag digits for EAN/JAN two-label pair 1. Options are:

- EAN/JAN13, EAN/JAN13 - 2 flag digits each
- EAN/JAN13 - 2 flag digits, EAN/JAN8 - 1 flag digit
- EAN/JAN13, EAN/JAN8 - 1 flag digit each
- Disable pairs





START / END	
PROGRAMMING BARCODES	
	EAN Two-Label Type 1 = EAN/JAN13, EAN/JAN13 - 2 flag digits each DEFAULT
EAN Two-Label Type 1 = EAN/JAN13 - 2 flag digits, EAN/JAN8 - 1 flag digit	
	EAN Two-Label Type 1 = EAN/JAN13, EAN/JAN8 - 1 flag digit each
EAN Two-Label Type 1 = Disable pairs	

EAN Two-Label — continued

EAN Two-Label Type 2

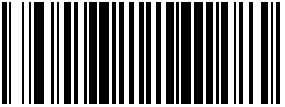
Specifies label types and number of flag digits for EAN/JAN two-label pair 2. Options are:

- EAN/JAN13, EAN/JAN13 - 2 flag digits each
- EAN/JAN13 - 2 flag digits, EAN/JAN8 - 1 flag digit
- EAN/JAN13, EAN/JAN8 - 1 flag digit each
- Disable pairs





START / END	
PROGRAMMING BARCODES	
	EAN Two-Label Type 2 = EAN/JAN13, EAN/JAN13 - 2 flag digits each DEFAULT
EAN Two-Label Type 2 = EAN/JAN13 - 2 flag digits, EAN/JAN8 - 1 flag digit	
	EAN Two-Label Type 2 = EAN/JAN13, EAN/JAN8 - 1 flag digit each
EAN Two-Label Type 2 = Disable pairs	

EAN Two-Label — continued

EAN Two-Label Type 3

Specifies label types and number of flag digits for EAN/JAN two-label pair 3. Options are:

- EAN/JAN13, EAN/JAN13 - 2 flag digits each
- EAN/JAN13 - 2 flag digits, EAN/JAN8 - 1 flag digit
- EAN/JAN13, EAN/JAN8 - 1 flag digit each
- Disable pairs



START / END	
PROGRAMMING BARCODES	
	EAN Two-Label Type 3 = EAN/JAN13, EAN/JAN13 - 2 flag digits each DEFAULT
EAN Two-Label Type 3 = EAN/JAN13 - 2 flag digits, EAN/JAN8 - 1 flag digit	
	EAN Two-Label Type 3 = EAN/JAN13, EAN/JAN8 - 1 flag digit each
EAN Two-Label Type 3 = Disable pairs	

EAN Two-Label — continued

EAN Two-Label Type 4

Specifies label types and number of flag digits for EAN/JAN two-label pair 4. Options are:

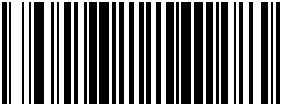
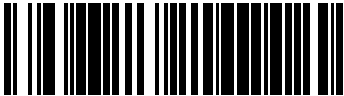
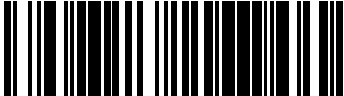

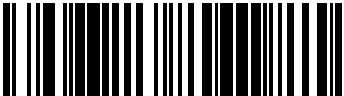
- EAN/JAN13, EAN/JAN13 - 2 flag digits each
- EAN/JAN13 - 2 flag digits, EAN/JAN8 - 1 flag digit
- EAN/JAN13, EAN/JAN8 - 1 flag digit each
- Disable pairs

START / END	
PROGRAMMING BARCODES	
	EAN Two-Label Type 4 = EAN/JAN13, EAN/JAN13 - 2 flag digits each
EAN Two-Label Type 4 = EAN/JAN13 - 2 flag digits, EAN/JAN8 - 1 flag digit	
	EAN Two-Label Type 4 = EAN/JAN13, EAN/JAN8 - 1 flag digit each DEFAULT
EAN Two-Label Type 4 = Disable pairs	

EAN Two-Label — continued

EAN Two-Label Combined Transmission

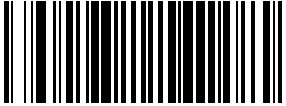

Enables/disables the transmitting of an EAN two label pair as one label.

START / END	
PROGRAMMING BARCODES	
	EAN Two-Label Combined Transmission = Disable DEFAULT
EAN Two-Label Combined Transmission = Enable	

EAN Two-Label — continued

EAN Two-Label Minimum Reads

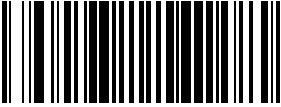
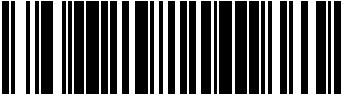
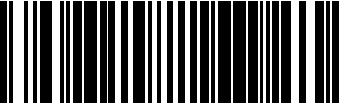
This feature specifies the minimum consecutive decodes of an EAN two-label pair before it is accepted as good read..

START / END	
PROGRAMMING BARCODES	
	Minimum = 1 Read DEFAULT
Minimum = 2 Reads	
	Minimum = 3 Reads
Minimum = 4 Reads	

Price Weight Check Digit

Enables/disables calculation and verification of price/weight check digits.



Applies to all UPC-A labels with a number-system character of 2 and EAN/JAN 13 labels with a Flag1 digit of 2

NOTE

Here are the available options for this feature:

- Disable
- Enable 4-digit price/wt check-digit calculation
- Enable 5-digit price/wt check-digit calculation
- Enable European 4-digit price-weight check-digit calculation
- Enable European 5-digit price-weight check-digit calculation

START / END	
PROGRAMMING BARCODES	
	Price Weight Check Digit = Disable DEFAULT
Price Weight Check Digit = Enable 4-digit price/wt	
	Price Weight Check Digit = Enable 5-digit price/wt
Price Weight Check Digit = Enable European 4-digit price/wt	
	Price Weight Check Digit = Enable European 5-digit price/wt

Add-ons

Add-ons (or supplemental characters) are commonly added to the end of UPC/EAN barcodes. The scanner will read the add-ons if they are enabled and in the field of view. Three add-on types are supported: 2-digit, 5-digit and Code 128 add-ons. Supported options are:

None— This option directs the scanner to ignore add-on portion of a UPC/EAN barcode but still read the main portion of the barcode.

2 Digits— The scanner will optionally read 2-digit add-ons with the UPC/EAN label.

5 Digits— The scanner will optionally read 5-digit add-ons with the UPC/EAN label.

Code 128 Add-on— The scanner will optionally read Code 128 add-ons with the UPC/EAN label.



NOTE

Contact Customer Support for advanced programming of optional and conditional add-ons.



Add-ons — continued

START / END	
PROGRAMMING BARCODES	
	Disable Optional 2-Digit Add-ons DEFAULT
Enable Optional 2-Digit Add-ons	
	Disable Optional 5-Digit Add-ons DEFAULT
Enable Optional 5-Digit Add-ons	
	Disable Optional Code 128 Add-ons DEFAULT
Enable Optional Code 128 Add-ons	

Add-ons — continued

2-Digit Addons Minimum Reads

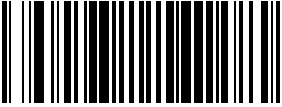
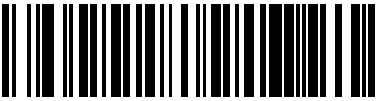

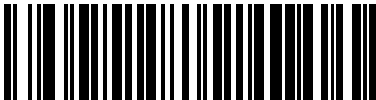
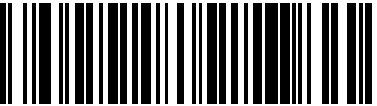
This setting configures the minimum number of times a 2-digit addon must decode before it is marked valid.

START / END	
PROGRAMMING BARCODES	
	Minimum = 1 Read
Minimum = 2 Reads DEFAULT	
	Minimum = 3 Reads
Minimum = 4 Reads	

Add-ons — continued

5-Digit Addons Minimum Reads

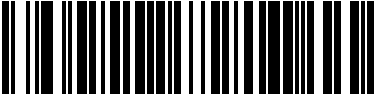
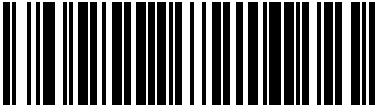
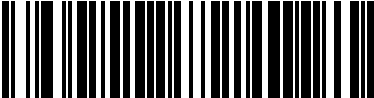
This setting configures the minimum number of times a 5-digit addon must decode before it is marked valid.

START / END	
PROGRAMMING BARCODES	
	Minimum = 1 Read DEFAULT
Minimum = 2 Reads	
	Minimum = 3 Reads
Minimum = 4 Reads	

GS1 DataBar Omnidirectional / Stacked Omnidirectional

The following options apply to the GS1 DataBar Omnidirectional symbology.



Disable/Enable GS1 DataBar Omnidirectional

When this feature is disabled, the scanner will not read GS1 DataBar Omnidirectional barcodes.

START / END	
PROGRAMMING BARCODES	
	Disable GS1 DataBar Omnidirectional DEFAULT
Enable GS1 DataBar Omnidirectional	

UCC/EAN 128 Emulation





When enabled, GS1 DataBar Omnidirectional barcodes will be translated to the UCC/EAN 128 label data format.

START / END	
PROGRAMMING BARCODES	
	Disable UCC/EAN 128 Emulation DEFAULT
Enable UCC/EAN 128 Emulation	

GS1 DataBar Omnidirectional / Stacked Omnidirectional — continued

Minimum Reads

This feature specifies the minimum number of consecutive times an GS1 DataBar Omnidirectional label must be decoded before it is accepted as good read.



START / END	
PROGRAMMING BARCODES	
	Minimum = 1 Read DEFAULT
Minimum = 2 Reads	
	Minimum = 3 Reads
Minimum = 4 Reads	

GS1 DataBar Expanded / Expanded Stacked

The following options apply to the GS1 DataBar Expanded symbology.



Disable/Enable GS1 DataBar Expanded

When this feature is disabled, the scanner will not read GS1 DataBar Expanded barcodes.

START / END	
PROGRAMMING BARCODES	
	Disable GS1 DataBar Expanded DEFAULT
Enable GS1 DataBar Expanded	

GS1-128 Emulation

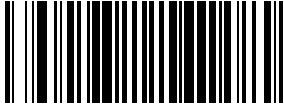
When enabled, GS1 DataBar Expanded barcodes will be translated to the GS1-128 label data format.

START / END	
PROGRAMMING BARCODES	
	Disable GS1-128 Emulation DEFAULT
Enable GS1-128 Emulation	

GS1 DataBar Expanded / Expanded Stacked — continued

Length Control

Fixed Length Decoding— When fixed length decoding is enabled, the scanner will decode a barcode if the label length matches one of the configurable fixed lengths.



Variable Length Decoding— When variable length decoding is enabled, the scanner will decode a barcode if the label length falls in the range of the configurable minimum and maximum length.

Configuring Fixed Length Decoding:

1. Scan the START/END barcode.
2. Scan the Fixed Length Decoding barcode.
3. Scan the START/END barcode.
4. Set Length 1 to the first fixed length by following the [GS1 DataBar Expanded Length 1, Length 2 Programming Instructions](#) below.
5. Set Length 2 to the second fixed length (or to '00' if there is only one fixed length) by following the [GS1 DataBar Expanded Length 1, Length 2 Programming Instructions](#) below.

Configuring Variable Length Decoding:

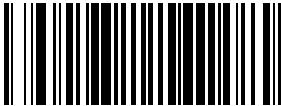
1. Scan the START/END barcode.
2. Scan the Variable Length Decoding barcode.
3. Scan the START/END barcode.
4. Set Length 1 to the first variable length by following the [GS1 DataBar Expanded Length 1, Length 2 Programming Instructions](#) below.
5. Set Length 2 to the second variable length by following the [GS1 DataBar Expanded Length 1, Length 2 Programming Instructions](#) below.

START / END	
PROGRAMMING BARCODES	
	Variable Length Decoding DEFAULT
Fixed Length Decoding	

GS1 DataBar Expanded / Expanded Stacked — continued

GS1 DataBar Expanded Length 1, Length 2 Programming Instructions

1. Scan the START/END barcode.
2. Scan either the Set Length 1 or Set Length 2 barcode.
3. Turn to [Appendix C, Alpha-Numeric Pad](#) and scan the two digits (zero padded) representing the length in decimal notation.



For GS1 DataBar Expanded barcodes, only the data characters are included in the length calculations.

NOTE



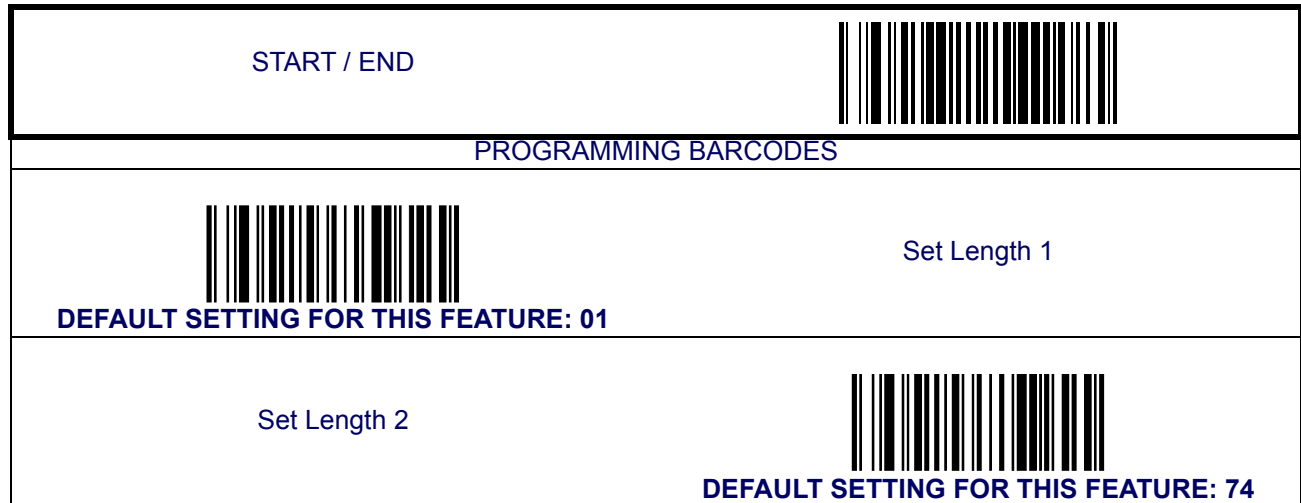

4. Scan the START/END barcode.



GS1 DataBar Expanded / Expanded Stacked — continued

Minimum Reads



This feature specifies the minimum number of consecutive times an GS1 DataBar Expanded label must be decoded before it is accepted as good read.

START / END	
PROGRAMMING BARCODES	
	Minimum = 1 Read DEFAULT
Minimum = 2 Reads	
	Minimum = 3 Reads
Minimum = 4 Reads	

GS1 DataBar Expanded / Expanded Stacked — continued

Coupon Read Control

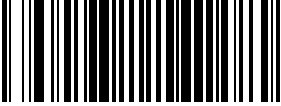
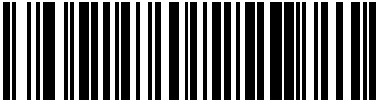
This feature controls coupon reading.

START / END	
PROGRAMMING BARCODES	
	Disable coupon filtering
Enable UPCA coupon decoding Disable GS1 DataBar coupon decoding DEFAULT	
	Enable GS1 DataBar coupon decoding Disable UPCA coupon decoding

GS1 DataBar Limited

The following options apply to the GS1 DataBar Limited symbology.

Disable/Enable GS1 DataBar Limited

When this feature is disabled, the scanner will not read GS1 DataBar Limited barcodes.

START / END	
PROGRAMMING BARCODES	
	Disable GS1 DataBar Limited DEFAULT
Enable GS1 DataBar Limited	

GS1-128 Emulation



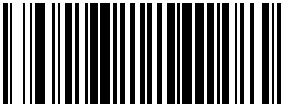
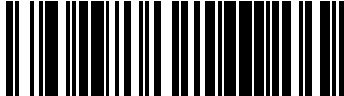
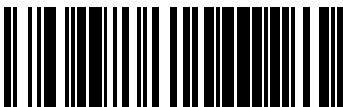

When enabled, GS1 DataBar Limited barcodes will be translated to the GS1-128 label data format.

START / END	
PROGRAMMING BARCODES	
	Disable GS1-128 Emulation DEFAULT
Enable GS1-128 Emulation	

GS1 DataBar Limited — continued

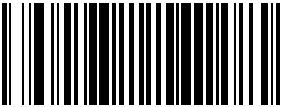
Minimum Reads

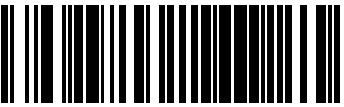
This feature specifies the minimum number of consecutive times an GS1 DataBar Limited label must be decoded before it is accepted as good read.

START / END	
PROGRAMMING BARCODES	
	Minimum = 1 Read DEFAULT
Minimum = 2 Reads	
	Minimum = 3 Reads
Minimum = 4 Reads	

Code 39

The following options apply to the Code 39 symbology.



Disable/Enable Code 39

When this feature is disabled, the scanner will not read Code 39 barcodes.

START / END	
PROGRAMMING BARCODES	
	Disable Code 39
Enable Code 39 DEFAULT	

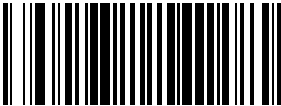

Check Character Calculation

When enabled, the scanner will calculate the check character of the labels. Turn this option on only when a checksum is present in the Code 39 labels.

START / END	
PROGRAMMING BARCODES	
	Disable Check Char Calculation DEFAULT
Enable Check Char Calculation	

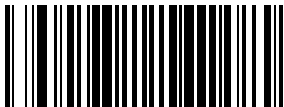

Check Character Transmit

Enable this option to transmit the check character with scanned barcode data.

START / END	
PROGRAMMING BARCODES	
	Disable Check Char Transmission
Enable Check Char Transmission DEFAULT	

Start/Stop Characters

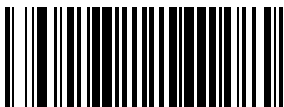
Enables/disables transmission of Code39 start and stop characters.

START / END	
PROGRAMMING BARCODES	
	Don't Transmit Start/Stop Characters DEFAULT
Transmit Start/Stop Characters	

Code 39 Full ASCII

Enables/disables the translation of Code 39 characters to Code 39 full-ASCII characters.

START / END	
PROGRAMMING BARCODES	
	Disable Code 39 Full ASCII DEFAULT
Enable Code 39 Full ASCII	

Code 39 — continued

Length Control

Fixed Length Decoding— When fixed length decoding is enabled, the scanner will decode a barcode if the label length matches one of the configurable fixed lengths.



Variable Length Decoding— When variable length decoding is enabled, the scanner will decode a barcode if the label length falls in the range of the configurable minimum and maximum length.

Configuring Fixed Length Decoding:

1. Scan the START/END barcode.
2. Scan the Fixed Length Decoding barcode.
3. Scan the START/END barcode.
4. Set Length 1 to the first fixed length by following the [Code 39 Length 1, Length 2 Programming Instructions](#) below.
5. Set Length 2 to the second fixed length (or to '00' if there is only one fixed length) by following the [Code 39 Length 1, Length 2 Programming Instructions](#) below.

Configuring Variable Length Decoding:

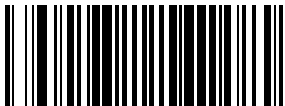
1. Scan the START/END barcode.
2. Scan the Variable Length Decoding barcode.
3. Scan the START/END barcode.
4. Set Length 1 to the first variable length by following the [Code 39 Length 1, Length 2 Programming Instructions](#) below.
5. Set Length 2 to the second variable length by following the [Code 39 Length 1, Length 2 Programming Instructions](#) below.

START / END	
PROGRAMMING BARCODES	
	Variable Length Decoding DEFAULT
Fixed Length Decoding	

Code 39 Length 1, Length 2 Programming Instructions



1. Scan the START/END barcode.
2. Scan either the Set Length 1 or Set Length 2 barcode.
3. Turn to [Appendix C, Alpha-Numeric Pad](#) and scan the two digits (zero padded) representing the length in decimal notation.



NOTE

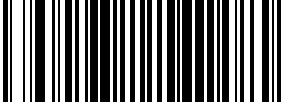

For Code 39 barcodes, all check, data and full ASCII shift characters are included in the length calculations. Start/Stop characters are not included.

4. Scan the START/END barcode.

START / END	
PROGRAMMING BARCODES	
	Set Length 1
DEFAULT SETTING FOR THIS FEATURE: 02	
Set Length 2	
DEFAULT SETTING FOR THIS FEATURE: 50	

Quiet Zones

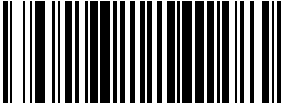

This feature enables/disables the requirement that quiet zones must be present for Code 39 barcodes.

START / END	
PROGRAMMING BARCODES	
	Don't require Quiet Zones DEFAULT
Require Quiet Zones	

Code 39 — continued



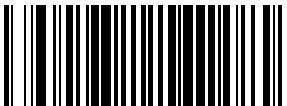

Code 39 Stitching

Enables/disables stitching for Code 39 labels. When parts of a Code 39 barcode are presented to the scanner with this feature enabled, the barcode parts will be assembled by the scanner's software, and the data will be decoded if all barcode proofing requirements are met.

START / END	
PROGRAMMING BARCODES	
	Disable Code 39 Stitching
Enable Code 39 Stitching DEFAULT	

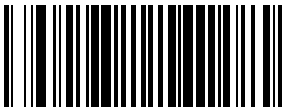
Minimum Reads

This feature specifies the minimum number of consecutive times a Code 39 label must be decoded before it is accepted as good read.

START / END	
PROGRAMMING BARCODES	
	Minimum = 1 Read DEFAULT
Minimum = 2 Reads	
	Minimum = 3 Reads
Minimum = 4 Reads	

Code 32 Italian Pharmacode

The following options apply to the Code 32 Italian Pharmacode symbology.



Disable/Enable Code 32 Italian Pharmacode

When this feature is disabled, the scanner will not read Code 32 Italian Pharmacode barcodes.

START / END	
PROGRAMMING BARCODES	
	Disable Code 32 Italian Pharmacode DEFAULT
Enable Code 32 Italian Pharmacode	

Start/Stop Characters



Enables or disables transmission of Code 32 Italian Pharmacode start/stop characters.

START / END	
PROGRAMMING BARCODES	
	Don't Transmit Start/Stop Characters DEFAULT
Transmit Start/Stop Characters	

Code 32 Italian Pharmacode – continued

Check Character Transmit

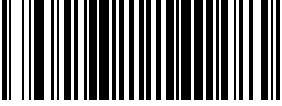
Enable this option to transmit the check character with scanned barcode data.

START / END	
PROGRAMMING BARCODES	
	Disable Check Char Transmission
Enable Check Char Transmission DEFAULT	

Code 128

The following options apply to the Code 128 symbology.

Disable/Enable Code 128

When this feature is disabled, the scanner will not read Code 128 barcodes.

START / END	
PROGRAMMING BARCODES	
	Disable Code 128
Enable Code 128 DEFAULT	

Disable/Enable EAN 128

When this feature is disabled, the scanner will not read EAN 128 barcodes.

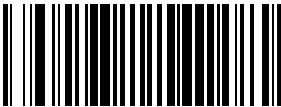
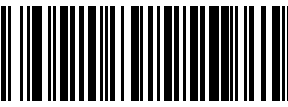

START / END	
PROGRAMMING BARCODES	
	Disable EAN 128
Enable EAN 128 DEFAULT	

Code 128 — continued

Transmit Function Characters

Enables/disables transmission of Code128 function characters 1, 2, 3, and 4.
Function codes are transmitted as follows:

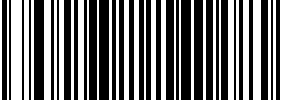
- FNC1 = 80 hex
- FNC2 = 81 hex
- FNC3 = 82 hex
- FNC4 = 83 hex

START / END	
PROGRAMMING BARCODES	
	Don't Transmit Function Characters DEFAULT
Transmit Function Characters	

Code 128 — continued

Length Control

Fixed Length Decoding— When fixed length decoding is enabled, the scanner will decode a barcode if the label length matches one of the configurable fixed lengths.



Variable Length Decoding— When variable length decoding is enabled, the scanner will decode a barcode if the label length falls in the range of the configurable minimum and maximum length.

Configuring Fixed Length Decoding:

1. Scan the START barcode.
2. Scan the Fixed Length Decoding barcode.
3. Scan the END barcode.
4. Set Length 1 to the first fixed length by following the [Code 128 Length 1, Length 2 Programming Instructions](#) below.
5. Set Length 2 to the second fixed length (or to '00' if there is only one fixed length) by following the [Code 128 Length 1, Length 2 Programming Instructions](#) below.

Configuring Variable Length Decoding:

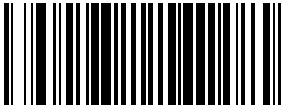
1. Scan the START barcode.
2. Scan the Variable Length Decoding barcode.
3. Scan the END barcode.
4. Set Length 1 to the first variable length by following the [Code 128 Length 1, Length 2 Programming Instructions](#) below.
5. Set Length 2 to the second variable length by following the [Code 128 Length 1, Length 2 Programming Instructions](#) below.

START / END	
PROGRAMMING BARCODES	
	Variable Length Decoding DEFAULT
Fixed Length Decoding	

Code 128 — continued

Code 128 Length 1, Length 2 Programming Instructions



1. Scan the START barcode.
2. Scan either the Set Length 1 or Set Length 2 barcode.
3. Turn to [Appendix C, Alpha-Numeric Pad](#) and scan the two digits (zero padded) representing the length in decimal notation.



For Code 128 barcodes, only the data characters are included in the length calculations.

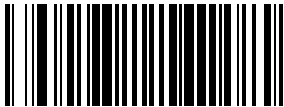

NOTE

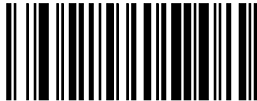
4. Scan the END barcode.

START / END	
PROGRAMMING BARCODES	
 DEFAULT SETTING FOR THIS FEATURE: 01	Set Length 1
Set Length 2	 DEFAULT SETTING FOR THIS FEATURE: 80

Code 128 Conversion to Code 39

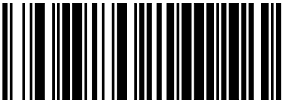

Enables/disables expansion of Code 128 labels to Code 39.

START / END	
PROGRAMMING BARCODES	
	Disable DEFAULT
Enable	

Code 128 — continued





Code 128 Stitching

Enables/disables stitching for Code 128 labels. When parts of a Code 128 barcode are presented to the scanner with this feature enabled, the barcode parts will be assembled by the scanner's software, and the data will be decoded if all barcode proofing requirements are met.

START / END	
PROGRAMMING BARCODES	
	Disable Code 128 Stitching
Enable Code 128 Stitching DEFAULT	

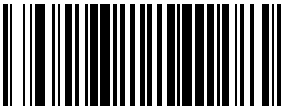
Minimum Reads

This feature specifies the minimum number of consecutive times a Code 128 label must be decoded before it is accepted as good read.



START / END	
PROGRAMMING BARCODES	
	Minimum = 1 Read DEFAULT
Minimum = 2 Reads	
	Minimum = 3 Reads
Minimum = 4 Reads	

Interleaved 2 of 5

The following options apply to the Interleaved 2 of 5 (I 2 of 5) symbology.



Disable/Enable Interleaved 2 of 5

When this feature is disabled, the scanner will not read Interleaved 2 of 5 barcodes.

START / END	
PROGRAMMING BARCODES	
	Disable Interleaved 2 of 5 DEFAULT
Enable Interleaved 2 of 5	

Check Digit Calculation

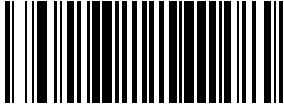

When enabled, the scanner will calculate the check digit of the labels.

START / END	
PROGRAMMING BARCODES	
	Disable Check Digit Calculation DEFAULT
Enable Check Digit Calculation	

Interleaved 2 of 5 — continued

Check Digit Transmit

Enable this option to transmit the check digit with scanned barcode data.

START / END	
PROGRAMMING BARCODES	
	Disable Check Digit Transmission DEFAULT
Enable Check Digit Transmission	

Interleaved 2 of 5 — continued

Length Control

Fixed Length Decoding— When fixed length decoding is enabled, the scanner will decode a barcode if the label length matches one of the configurable fixed lengths.



Variable Length Decoding— When variable length decoding is enabled, the scanner will decode a barcode if the label length falls in the range of the configurable minimum and maximum length.

Configuring Fixed Length Decoding:

1. Scan the START barcode.
2. Scan the Fixed Length Decoding barcode.
3. Scan the END barcode.
4. Set Length 1 to the first fixed length by following the [Interleaved 2 of 5 Length 1, Length 2 Programming Instructions](#) below.
5. Set Length 2 to the second fixed length (or to '00' if there is only one fixed length) by following the [Interleaved 2 of 5 Length 1, Length 2 Programming Instructions](#) below.

Configuring Variable Length Decoding:

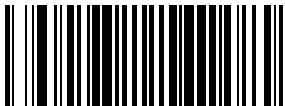
1. Scan the START barcode.
2. Scan the Variable Length Decoding barcode.
3. Scan the END barcode.
4. Set Length 1 to the first variable length by following the [Interleaved 2 of 5 Length 1, Length 2 Programming Instructions](#) below.
5. Set Length 2 to the second variable length by following the [Interleaved 2 of 5 Length 1, Length 2 Programming Instructions](#) below.

START / END	
PROGRAMMING BARCODES	
	Variable Length Decoding DEFAULT
Fixed Length Decoding	

Interleaved 2 of 5 — continued

Interleaved 2 of 5 Length 1, Length 2 Programming Instructions



1. Scan the START barcode.
2. Scan either the Set Length 1 or Set Length 2 barcode.
3. Turn to [Appendix C, Alpha-Numeric Pad](#) and scan the two digits (zero padded) representing the length in decimal notation.



NOTE

For Interleaved 2 of 5 barcodes, lengths must be an even number. Additionally, all check and data characters are included in the length calculations.

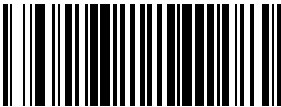
4. Scan the END barcode.

START / END	
PROGRAMMING BARCODES	
 DEFAULT SETTING FOR THIS FEATURE: 06	Set Length 1
Set Length 2	 DEFAULT SETTING FOR THIS FEATURE: 50

Interleaved 2 of 5 — continued

Interleaved 2 of 5 Stitching

Enables/disables stitching for Interleaved 2 of 5 labels. When parts of an Interleaved 2 of 5 barcode are presented to the scanner with this feature enabled, the barcode parts will be assembled by the scanner's software, and the data will be decoded if all barcode proofing requirements are met.



Only functions when Fixed Length Decoding is enabled.



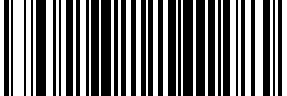

NOTE

START / END	
PROGRAMMING BARCODES	
	Disable Interleaved 2 of 5 Stitching DEFAULT
Enable Interleaved 2 of 5 Stitching	

Interleaved 2 of 5 — continued

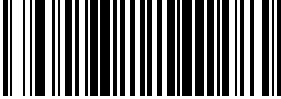
Minimum Reads

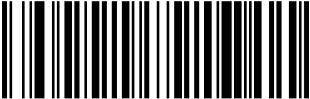
This feature specifies the minimum number of consecutive times an Interleaved 2 of 5 label must be decoded before it is accepted as good read.



START / END	
PROGRAMMING BARCODES	
	Minimum = 1 Read DEFAULT
Minimum = 2 Reads	
	Minimum = 3 Reads
Minimum = 4 Reads	

Codabar

The following options apply to the Codabar symbology.

Disable/Enable Codabar

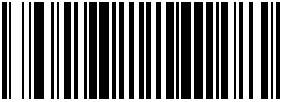
When this feature is disabled, the scanner will not read Codabar barcodes.

START / END	
PROGRAMMING BARCODES	
	Disable Codabar DEFAULT
Enable Codabar	

Check Character Verification

When enabled, the scanner will verify the check character of the labels.

START / END	
PROGRAMMING BARCODES	
	Disable Check Char Verification DEFAULT
Enable Check Char Verification	

Check Character Transmit

Enable this option to transmit the check character with scanned barcode data.

START / END	
PROGRAMMING BARCODES	
	Disable Check Char Transmission
Enable Check Char Transmission DEFAULT	

Codabar — continued

Length Control

Fixed Length Decoding— When fixed length decoding is enabled, the scanner will decode a barcode if the label length matches one of the configurable fixed lengths.



Variable Length Decoding— When variable length decoding is enabled, the scanner will decode a barcode if the label length falls in the range of the configurable minimum and maximum length.

Configuring Fixed Length Decoding:

1. Scan the START barcode.
2. Scan the Fixed Length Decoding barcode.
3. Scan the END barcode.
4. Set Length 1 to the first fixed length by following the [Codabar Length 1, Length 2 Programming Instructions](#) below.
5. Set Length 2 to the second fixed length (or to '00' if there is only one fixed length) by following the [Codabar Length 1, Length 2 Programming Instructions](#) below.

Configuring Variable Length Decoding:

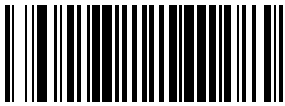
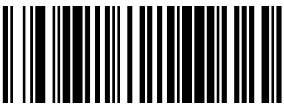
1. Scan the START barcode.
2. Scan the Variable Length Decoding barcode.
3. Scan the END barcode.
4. Set Length 1 to the first variable length by following the [Codabar Length 1, Length 2 Programming Instructions](#) below.
5. Set Length 2 to the second variable length by following the [Codabar Length 1, Length 2 Programming Instructions](#) below.

START / END	
PROGRAMMING BARCODES	
	Variable Length Decoding DEFAULT
Fixed Length Decoding	

Codabar — continued

Codabar Length 1, Length 2 Programming Instructions



1. Scan the START barcode.
2. Scan either the Set Length 1 or Set Length 2 barcode.
3. Turn to [Appendix C, Alpha-Numeric Pad](#) and scan the two digits (zero padded) representing the length in decimal notation.



For Codabar barcodes, all start, stop, check and data characters are included in the length calculations.

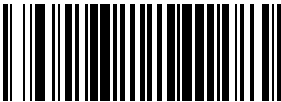

NOTE

4. Scan the END barcode.

START / END	
PROGRAMMING BARCODES	
	Set Length 1
DEFAULT SETTING FOR THIS FEATURE: 03	
Set Length 2	
DEFAULT SETTING FOR THIS FEATURE: 50	

Quiet Zones

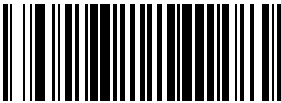



This feature enable/disables the requirement that quiet zones must be present for Codabar barcodes.

START / END	
PROGRAMMING BARCODES	
	Don't require Quiet Zones DEFAULT
Require Quiet Zones	

Codabar — continued

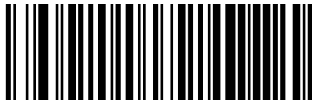

Start/Stop Character Type

Codabar has four pairs of Start/Stop patterns. Select one pair to match your application.

START / END		
PROGRAMMING BARCODES		
	Start/Stop Type: ABCD/TN*E	
Start/Stop Type: ABCD/ABCD		
	Start/Stop Type: abcd/tn*e	
Start/Stop Type: abcd/abcd DEFAULT		

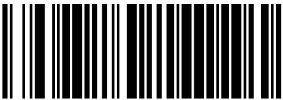

Start/Stop Character Transmission

The transmission of start and end characters of Codabar is selected below.

START / END		
PROGRAMMING BARCODES		
	Disable Start/Stop Char Transmission	
Enable Start/Stop Char Transmission DEFAULT		

Start/Stop Character Match

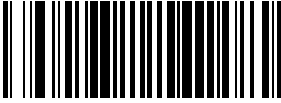
This feature enables/disables the requirement that start and stop characters match.

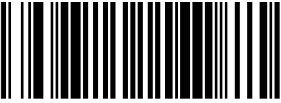
START / END	
PROGRAMMING BARCODES	
	Disable Start/Stop Char Match DEFAULT
Enable Start/Stop Char Match	

Codabar Stitching

Enables/disables stitching for Codabar labels. When parts of a Codabar label are presented to the scanner with this feature enabled, the barcode parts will be assembled by the scanner's software, and the data will be decoded if all barcode proofing requirements are met.



NOTE





Only functions when **Fixed Length Decoding** is enabled.

START / END	
PROGRAMMING BARCODES	
	Disable Codabar Stitching DEFAULT
Enable Codabar Stitching	

Codabar — continued

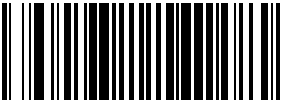
Minimum Reads

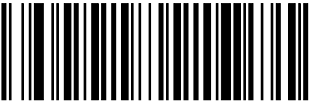
This feature specifies the minimum number of consecutive times a Codabar label must be decoded before it is accepted as a good read.

START / END	
PROGRAMMING BARCODES	
	Minimum = 1 Read DEFAULT
Minimum = 2 Reads	
	Minimum = 3 Reads
Minimum = 4 Reads	

Code 93

The following options apply to the Code 93 symbology.

Disable/Enable Code 93

When this feature is disabled, the scanner will not read Code 93 barcodes.

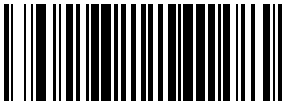
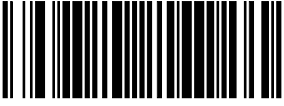
START / END	
PROGRAMMING BARCODES	
	Disable Code 93 DEFAULT
Enable Code 93	

Code 93 — continued

Length Control

Fixed Length Decoding— When fixed length decoding is enabled, the scanner will decode a barcode if the label length matches one of the configurable fixed lengths.



Variable Length Decoding— When variable length decoding is enabled, the scanner will decode a barcode if the label length falls in the range of the configurable minimum and maximum length.

Configuring Fixed Length Decoding:

1. Scan the START/END barcode.
2. Scan the Fixed Length Decoding barcode.
3. Scan the START/END barcode.
4. Set Length 1 to the first fixed length by following the [Code 93 Length 1, Length 2 Programming Instructions](#) below.
5. Set Length 2 to the second fixed length (or to '00' if there is only one fixed length) by following the [Code 93 Length 1, Length 2 Programming Instructions](#) below.

Configuring Variable Length Decoding:

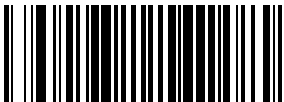
1. Scan the START/END barcode.
2. Scan the Variable Length Decoding barcode.
3. Scan the START/END barcode.
4. Set Length 1 to the first variable length by following the [Code 93 Length 1, Length 2 Programming Instructions](#) below.
5. Set Length 2 to the second variable length by following the [Code 93 Length 1, Length 2 Programming Instructions](#) below.

START / END	
PROGRAMMING BARCODES	
	Variable Length Decoding DEFAULT
Fixed Length Decoding	

Code 93 — continued

Code 93 Length 1, Length 2 Programming Instructions



1. Scan the START barcode.
2. Scan either the Set Length 1 or Set Length 2 barcode.
3. Turn to [Appendix C, Alpha-Numeric Pad](#) and scan the two digits (zero padded) representing the length in decimal notation.



For Code 93 barcodes, only the data characters are included in the length calculations.

NOTE

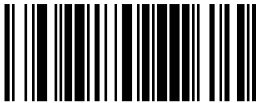
4. Scan the END barcode.

START / END	
PROGRAMMING BARCODES	
 DEFAULT SETTING FOR THIS FEATURE: 01	Set Length 1
Set Length 2	 DEFAULT SETTING FOR THIS FEATURE: 50

Code 93 — continued





Code 93 Stitching

Enables/disables stitching for Code 93 barcodes. When parts of a Code 93 label are presented to the scanner with this feature enabled, the barcode parts will be assembled by the scanner's software, and the data will be decoded if all barcode proofing requirements are met.

START / END	
PROGRAMMING BARCODES	
	Disable Code 93 Stitching DEFAULT
Enable Code 93 Stitching	

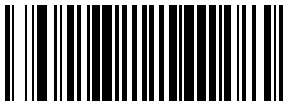
Minimum Reads

This feature specifies the minimum number of consecutive times a Code 93 label must be decoded before it is accepted as a good read.

START / END	
PROGRAMMING BARCODES	
	Minimum = 1 Read DEFAULT
Minimum = 2 Reads	
	Minimum = 3 Reads
Minimum = 4 Reads	

MSI/Plessey

The following options apply to the MSI/Plessey symbology.



Disable/Enable MSI/Plessey

When this feature is disabled, the scanner will not read MSI/Plessey barcodes.

START / END	
PROGRAMMING BARCODES	
	Disable MSI/Plessey DEFAULT
Enable MSI/Plessey	

Check Digit Verification

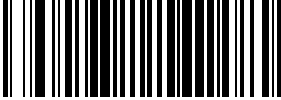
This feature specifies whether one or two check digits are to be calculated and verified.

START / END	
PROGRAMMING BARCODES	
	Disable Check Digit Verification DEFAULT
Enable Check Digit Verification	

MSI/Plessey — continued



Check Digit Transmit

When this option is enabled, the scanner will transmit one-digit or two-digit check digits, depending upon the setting for check digit verification.

START / END	
PROGRAMMING BARCODES	
	Disable Check Digit Transmission
Enable Check Digit Transmission DEFAULT	

Number of Check Characters

Specifies number of MSI/Plessey check characters to be calculated and verified

START / END	
PROGRAMMING BARCODES	
	1 Check Character DEFAULT
2 Check Characters	

MSI/Plessey — continued

Length Control

Fixed Length Decoding— When fixed length decoding is enabled, the scanner will decode a barcode if the label length matches one of the configurable fixed lengths.



Variable Length Decoding— When variable length decoding is enabled, the scanner will decode a barcode if the label length falls in the range of the configurable minimum and maximum length.

Configuring Fixed Length Decoding:

1. Scan the START/END barcode.
2. Scan the Fixed Length Decoding barcode.
3. Scan the START/END barcode.
4. Set Length 1 to the first fixed length by following the [MSI/Plessey Length 1, Length 2 Programming Instructions](#) below.
5. Set Length 2 to the second fixed length (or to '00' if there is only one fixed length) by following the [MSI/Plessey Length 1, Length 2 Programming Instructions](#) below.

Configuring Variable Length Decoding:

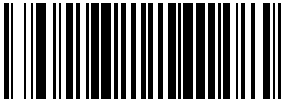
1. Scan the START/END barcode.
2. Scan the Variable Length Decoding barcode.
3. Scan the START/END barcode.
4. Set Length 1 to the first variable length by following the [MSI/Plessey Length 1, Length 2 Programming Instructions](#) below.
5. Set Length 2 to the second variable length by following the [MSI/Plessey Length 1, Length 2 Programming Instructions](#) below.

START / END	
PROGRAMMING BARCODES	
	Variable Length Decoding DEFAULT
Fixed Length Decoding	

MSI/Plessey — continued

MSI/Plessey Length 1, Length 2 Programming Instructions



1. Scan the START barcode.
2. Scan either the Set Length 1 or Set Length 2 barcode.
3. Turn to [Appendix C, Alpha-Numeric Pad](#) and scan the two digits (zero padded) representing the length in decimal notation.



For MSI/Plessey barcodes, all check and data characters are included in the length calculations.

NOTE

4. Scan the END barcode.

START / END	
PROGRAMMING BARCODES	
 DEFAULT SETTING FOR THIS FEATURE: 04	Set Length 1
Set Length 2	 DEFAULT SETTING FOR THIS FEATURE: 16

MSI/Plessey — continued



MSI/Plessey Stitching

Enables/disables stitching for MSI/Plessey barcodes. When parts of an MSI/Plessey label are presented to the scanner with this feature enabled, the barcode parts will be assembled by the scanner's software, and the data will be decoded if all barcode proofing requirements are met.



Only functions when Fixed Length Decoding is enabled.

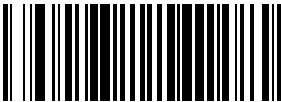



NOTE

START / END	
PROGRAMMING BARCODES	
	Disable MSI/Plessey Stitching DEFAULT
Enable MSI/Plessey Stitching	

MSI/Plessey — continued

Minimum Reads

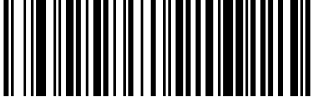
This feature specifies the minimum number of consecutive times an MSI/Plessey label must be decoded before it is accepted as good read.



START / END	
PROGRAMMING BARCODES	
	Minimum = 1 Read DEFAULT
Minimum = 2 Reads	
	Minimum = 3 Reads
Minimum = 4 Reads	

Standard 2 of 5

The following options apply to the Standard 2 of 5 symbology.

Disable/Enable Standard 2 of 5

When this feature is disabled, the scanner will not read Standard 2 of 5 barcodes.

START / END	
PROGRAMMING BARCODES	
	Disable Std 2 of 5 DEFAULT
Enable Std 2 of 5	

Check Digit Verification

When enabled, the scanner will verify the check digit of the labels.

START / END	
PROGRAMMING BARCODES	
	Disable Check Digit Verification DEFAULT
Enable Check Digit Verification	

Standard 2 of 5 — continued

Check Digit Transmit

When this option is enabled, the scanner will transmit the check digit.

START / END	
PROGRAMMING BARCODES	
	Disable Check Digit Transmission
Enable Check Digit Transmission DEFAULT	

Standard 2 of 5 — continued

Length Control

Fixed Length Decoding— When fixed length decoding is enabled, the scanner will decode a barcode if the label length matches one of the configurable fixed lengths.



Variable Length Decoding— When variable length decoding is enabled, the scanner will decode a barcode if the label length falls in the range of the configurable minimum and maximum length.

Configuring Fixed Length Decoding:

1. Scan the START/END barcode.
2. Scan the Fixed Length Decoding barcode.
3. Scan the START/END barcode.
4. Set Length 1 to the first fixed length by following the [Standard 2 of 5 Length 1, Length 2 Programming Instructions](#) below.
5. Set Length 2 to the second fixed length (or to '00' if there is only one fixed length) by following the [Standard 2 of 5 Length 1, Length 2 Programming Instructions](#) below.

Configuring Variable Length Decoding:

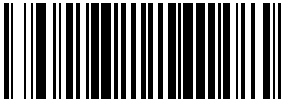
1. Scan the START/END barcode.
2. Scan the Variable Length Decoding barcode.
3. Scan the START/END barcode.
4. Set Length 1 to the first variable length by following the [Standard 2 of 5 Length 1, Length 2 Programming Instructions](#) below.
5. Set Length 2 to the second variable length by following the [Standard 2 of 5 Length 1, Length 2 Programming Instructions](#) below.

START / END	
PROGRAMMING BARCODES	
	Variable Length Decoding DEFAULT
Fixed Length Decoding	

Standard 2 of 5 — continued

Standard 2 of 5 Length 1, Length 2 Programming Instructions



1. Scan the START barcode.
2. Scan either the Set Length 1 or Set Length 2 barcode.
3. Turn to [Appendix C, Alpha-Numeric Pad](#) and scan the two digits (zero padded) representing the length in decimal notation.



For Standard 2 of 5 barcodes, all check and data characters are included in the length calculations.

NOTE

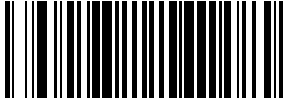
4. Scan the END barcode.

START / END	
PROGRAMMING BARCODES	
 DEFAULT SETTING FOR THIS FEATURE: 08	Set Length 1
Set Length 2	 DEFAULT SETTING FOR THIS FEATURE: 50

Standard 2 of 5 — continued



Standard 2 of 5 Stitching

Enables/disables stitching for Standard 2 of 5 barcodes. When parts of a Standard 2 of 5 label are presented to the scanner with this feature enabled, the barcode parts will be assembled by the scanner's software, and the data will be decoded if all barcode proofing requirements are met.



Only functions when Fixed Length Decoding is enabled.

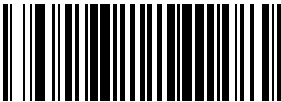

NOTE

START / END	
PROGRAMMING BARCODES	
	Disable Std 2 of 5 Stitching DEFAULT
Enable Std 2 of 5 Stitching	

Standard 2 of 5 — continued

Minimum Reads

This feature specifies the minimum number of consecutive times a Standard 2 of 5 label must be decoded before it is accepted as good read.

START / END	
PROGRAMMING BARCODES	
	Minimum = 1 Read DEFAULT
Minimum = 2 Reads	
	Minimum = 3 Reads
Minimum = 4 Reads	

NOTES

2D Symbologies



The features in this section are available **ONLY** for models with **2D features activated**.

NOTE

2D Symbologies

The scanner supports the 2D symbologies (barcode types) listed below. Available options for each 2D symbology are included in this chapter.

- PDF 417
- Micro PDF 417
- Datamatrix
- QR Code
- Maxicode
- Aztec
- Composite Labels

Factory Defaults— for the standard RS-232 interface are indicated in bold text throughout.

2D Decode Time Max

This feature sets the maximum amount of time the software will spend attempting to decode a 2D label. Follow these instructions to configure this feature:

1. Scan the START barcode.
2. Scan the Set 2D Decode Time Max barcode.
3. Turn to **Alpha-Numeric Pad** and scan the two digits (zero-padded) representing the desired contrast in decimal notation. The configurable range is 01-0xFF by 01 in increments of 10 msec.
4. Scan the END barcode.

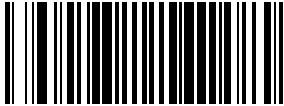
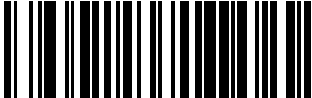
START / END	
PROGRAMMING BARCODES	
	Set 2D Decode Time Max DEFAULT SETTING FOR THIS FEATURE: 350 msec

PDF 417

Disable/Enable PDF 417

When disabled, the scanner will not read PDF 417 barcodes.

START / END	
PROGRAMMING BARCODES	
	Disable PDF 417
Enable PDF 417 DEFAULT	

PDF 417 — continued

Length Control

Fixed Length Decoding— When fixed length decoding is enabled, the scanner will decode a barcode if the label length matches one of the configurable fixed lengths.



Variable Length Decoding— When variable length decoding is enabled, the scanner will decode a barcode if the label length falls in the range of the configurable minimum and maximum length.

Configuring Fixed Length Decoding:

1. Scan the START barcode.
2. Scan the Fixed Length Decoding barcode.
3. Scan the END barcode.
4. Set Length 1 to the first fixed length by following the Length 1, Length 2 Programming Instructions below.
5. Set Length 2 to the second fixed length (or to '0000' if there is only one fixed length) by following the [PDF 417 Length 1, Length 2 Programming Instructions](#) below.

Configuring Variable Length Decoding:

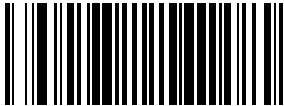
1. Scan the START barcode.
2. Scan the Variable Length Decoding barcode.
3. Scan the END barcode.
4. Set Length 1 to the minimum length by following the [PDF 417 Length 1, Length 2 Programming Instructions](#) below.
5. Set Length 2 to the maximum length by following the [PDF 417 Length 1, Length 2 Programming Instructions](#) below.

START / END	
PROGRAMMING BARCODES	
	Variable Length Decoding DEFAULT
Fixed Length Decoding	

PDF 417 – continued

PDF 417 Length 1, Length 2 Programming Instructions

1. Scan the START barcode.
2. Scan either the Set Length 1 or Set Length 2 barcode.
3. Turn to **Alpha-Numeric Pad** and scan the four digits (zero-padded) representing the length.





For PDF 417 barcodes, only the data characters are included in the length calculations.

NOTE

Any value set higher than 2710 will be considered to be 2710.

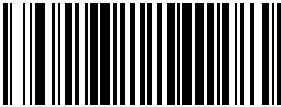
Scan the END barcode.

START / END	
PROGRAMMING BARCODES	
 DEFAULT SETTING FOR THIS FEATURE: 0001	Set Length 1
Set Length 2	 DEFAULT SETTING FOR THIS FEATURE: 2710

Micro PDF 417

Disable/Enable Micro PDF 417

When disabled, the scanner will not read Micro PDF 417 barcodes.

START / END	
PROGRAMMING BARCODES	
	Disable Micro PDF 417 DEFAULT
Enable Micro PDF 417	

Micro PDF 417 – continued

Length Control

Fixed Length Decoding— When fixed length decoding is enabled, the scanner will decode a barcode if the label length matches one of the configurable fixed lengths.



Variable Length Decoding— When variable length decoding is enabled, the scanner will decode a barcode if the label length falls in the range of the configurable minimum and maximum length.

Configuring Fixed Length Decoding:

1. Scan the START barcode.
2. Scan the Fixed Length Decoding barcode.
3. Scan the END barcode.
4. Set Length 1 to the first fixed length by following the Length 1, Length 2 Programming Instructions below.
5. Set Length 2 to the second fixed length (or to '0000' if there is only one fixed length) by following the [Micro PDF 417 Length 1, Length 2 Programming Instructions](#) below.

Configuring Variable Length Decoding:

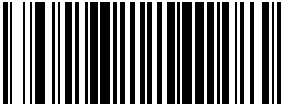
1. Scan the START barcode.
2. Scan the Variable Length Decoding barcode.
3. Scan the END barcode.
4. Set Length 1 to the minimum length by following the [Micro PDF 417 Length 1, Length 2 Programming Instructions](#) below.
5. Set Length 2 to the maximum length by following the [Micro PDF 417 Length 1, Length 2 Programming Instructions](#) below.

START / END	
PROGRAMMING BARCODES	
	Variable Length Decoding DEFAULT
Fixed Length Decoding	

Micro PDF 417 — continued

Micro PDF 417 Length 1, Length 2 Programming Instructions

1. Scan the START barcode.
2. Scan either the Set Length 1 or Set Length 2 barcode.
3. Turn to [Alpha-Numeric Pad](#) and scan the four digits (zero-padded) representing the length.



For Micro PDF 417 barcodes, only the data characters are included in the length calculations.

NOTE

Any value set higher than 366 will be considered to be 366.

Scan the END barcode.

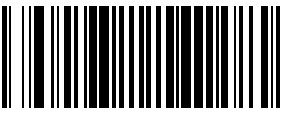
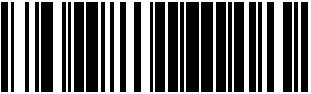
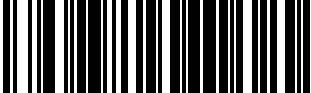
START / END	
PROGRAMMING BARCODES	
 DEFAULT SETTING FOR THIS FEATURE: 0001	Set Length 1
Set Length 2	 DEFAULT SETTING FOR THIS FEATURE: 0366

Datamatrix

Disable/Enable Datamatrix

When disabled, the scanner will not read Datamatrix barcodes.

START / END	
PROGRAMMING BARCODES	
	Disable Datamatrix
Enable Datamatrix DEFAULT	

Datamatrix — continued

Length Control

Fixed Length Decoding— When fixed length decoding is enabled, the scanner will decode a barcode if the label length matches one of the configurable fixed lengths.



Variable Length Decoding— When variable length decoding is enabled, the scanner will decode a barcode if the label length falls in the range of the configurable minimum and maximum length.

Configuring Fixed Length Decoding:

1. Scan the START barcode.
2. Scan the Fixed Length Decoding barcode.
3. Scan the END barcode.
4. Set Length 1 to the first fixed length by following the Length 1, Length 2 Programming Instructions below.
5. Set Length 2 to the second fixed length (or to '0000' if there is only one fixed length) by following the [Datamatrix Length 1, Length 2 Programming Instructions](#) below.

Configuring Variable Length Decoding:

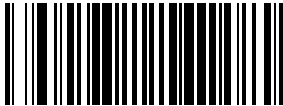
1. Scan the START barcode.
2. Scan the Variable Length Decoding barcode.
3. Scan the END barcode.
4. Set Length 1 to the minimum length by following the [Datamatrix Length 1, Length 2 Programming Instructions](#) below.
5. Set Length 2 to the maximum length by following the [Datamatrix Length 1, Length 2 Programming Instructions](#) below.

START / END	
PROGRAMMING BARCODES	
	Variable Length Decoding DEFAULT
Fixed Length Decoding	

Datamatrix – continued

Datamatrix Length 1, Length 2 Programming Instructions

1. Scan the START barcode.
2. Scan either the Set Length 1 or Set Length 2 barcode.
3. Turn to [Alpha-Numeric Pad](#) and scan the four digits (zero-padded) representing the length.





For Datamatrix barcodes, only the data characters are included in the length calculations.

NOTE

Any value set higher than 800 will be considered to be 800.

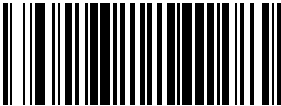
Scan the END barcode.

START / END	
PROGRAMMING BARCODES	
 DEFAULT SETTING FOR THIS FEATURE: 0001	Set Length 1
Set Length 2	 DEFAULT SETTING FOR THIS FEATURE: 0800

QR Code

Disable/Enable QR Code

When disabled, the scanner will not read QR Code labels.

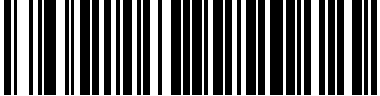
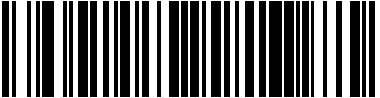
START / END	
PROGRAMMING BARCODES	
	Disable QR Code DEFAULT
Enable QR Code	

QR Code — continued

Length Control

Fixed Length Decoding— When fixed length decoding is enabled, the scanner will decode a barcode if the label length matches one of the configurable fixed lengths.



Variable Length Decoding— When variable length decoding is enabled, the scanner will decode a barcode if the label length falls in the range of the configurable minimum and maximum length.

Configuring Fixed Length Decoding:

1. Scan the START barcode.
2. Scan the Fixed Length Decoding barcode.
3. Scan the END barcode.
4. Set Length 1 to the first fixed length by following the Length 1, Length 2 Programming Instructions below.
5. Set Length 2 to the second fixed length (or to '0000' if there is only one fixed length) by following the [QR Code Length 1, Length 2 Programming Instructions](#) below.

Configuring Variable Length Decoding:

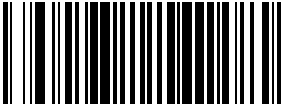
1. Scan the START barcode.
2. Scan the Variable Length Decoding barcode.
3. Scan the END barcode.
4. Set Length 1 to the minimum length by following the [QR Code Length 1, Length 2 Programming Instructions](#) below.
5. Set Length 2 to the maximum length by following the [QR Code Length 1, Length 2 Programming Instructions](#) below.

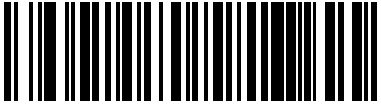
START / END	
PROGRAMMING BARCODES	
	Variable Length Decoding DEFAULT
Fixed Length Decoding	

QR Code – continued

QR Code Length 1, Length 2 Programming Instructions

1. Scan the START barcode.
2. Scan either the Set Length 1 or Set Length 2 barcode.
3. Turn to [Alpha-Numeric Pad](#) and scan the four digits (zero-padded) representing the length.





For QR Code labels, only the data characters are included in the length calculations.

NOTE

Any value set higher than 2710 will be considered to be 2710.

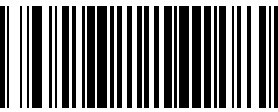
Scan the END barcode.

START / END	
PROGRAMMING BARCODES	
 DEFAULT SETTING FOR THIS FEATURE: 0001	Set Length 1
Set Length 2	 DEFAULT SETTING FOR THIS FEATURE: 2710

Maxicode

Disable/Enable Maxicode

When disabled, the scanner will not read Maxicode labels.

START / END	
PROGRAMMING BARCODES	
	Disable Maxicode DEFAULT
Enable Maxicode	

Maxicode — continued

Length Control

Fixed Length Decoding— When fixed length decoding is enabled, the scanner will decode a barcode if the label length matches one of the configurable fixed lengths.

Variable Length Decoding— When variable length decoding is enabled, the scanner will decode a barcode if the label length falls in the range of the configurable minimum and maximum length.

Configuring Fixed Length Decoding:

1. Scan the START barcode.
2. Scan the Fixed Length Decoding barcode.
3. Scan the END barcode.
4. Set Length 1 to the first fixed length by following the Length 1, Length 2 Programming Instructions below.
5. Set Length 2 to the second fixed length (or to '0000' if there is only one fixed length) by following the [Maxicode Length 1, Length 2 Programming Instructions](#) below.

Configuring Variable Length Decoding:

1. Scan the START barcode.
2. Scan the Variable Length Decoding barcode.
3. Scan the END barcode.
4. Set Length 1 to the minimum length by following the [Maxicode Length 1, Length 2 Programming Instructions](#) below.
5. Set Length 2 to the maximum length by following the [Maxicode Length 1, Length 2 Programming Instructions](#) below.

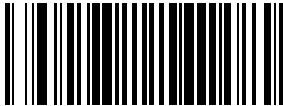
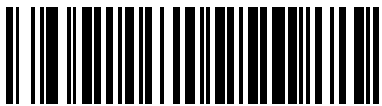
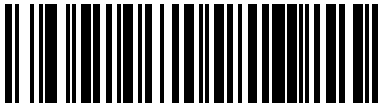
START / END	
PROGRAMMING BARCODES	
	Variable Length Decoding DEFAULT
Fixed Length Decoding	

Maxicode – continued

Maxicode Length 1, Length 2 Programming Instructions

1. Scan the START barcode.
2. Scan either the Set Length 1 or Set Length 2 barcode.
3. Turn to [Alpha-Numeric Pad](#) and scan the four digits (zero-padded) representing the length.





For Maxicode labels, only the data characters are included in the length calculations.

NOTE

Any value set higher than 138 will be considered to be 138.

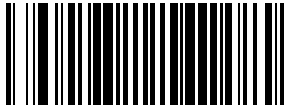
Scan the END barcode.

START / END	
PROGRAMMING BARCODES	
 DEFAULT SETTING FOR THIS FEATURE: 0001	Set Length 1
Set Length 2	 DEFAULT SETTING FOR THIS FEATURE: 0138

Aztec

Disable/Enable Aztec

When disabled, the scanner will not read Aztec labels.

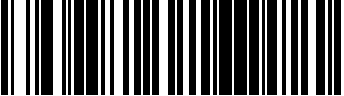
START / END	
PROGRAMMING BARCODES	
	Disable Aztec DEFAULT
Enable Aztec	

Aztec – continued

Length Control

Fixed Length Decoding— When fixed length decoding is enabled, the scanner will decode a barcode if the label length matches one of the configurable fixed lengths.

Variable Length Decoding— When variable length decoding is enabled, the scanner will decode a barcode if the label length falls in the range of the configurable minimum and maximum length.

Configuring Fixed Length Decoding:

1. Scan the START barcode.
2. Scan the Fixed Length Decoding barcode.
3. Scan the END barcode.
4. Set Length 1 to the first fixed length by following the Length 1, Length 2 Programming Instructions below.
5. Set Length 2 to the second fixed length (or to '0000' if there is only one fixed length) by following the [Aztec Length 1, Length 2 Programming Instructions](#) below.

Configuring Variable Length Decoding:

1. Scan the START barcode.
2. Scan the Variable Length Decoding barcode.
3. Scan the END barcode.
4. Set Length 1 to the minimum length by following the [Aztec Length 1, Length 2 Programming Instructions](#) below.
5. Set Length 2 to the maximum length by following the [Aztec Length 1, Length 2 Programming Instructions](#) below.

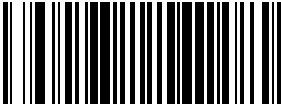
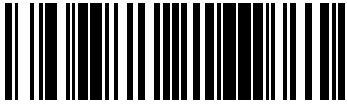
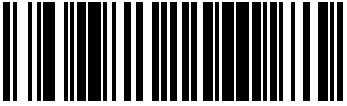
START / END	
PROGRAMMING BARCODES	
	Variable Length Decoding DEFAULT
Fixed Length Decoding	

Aztec – continued

Aztec Length 1, Length 2 Programming Instructions

1. Scan the START barcode.
2. Scan either the Set Length 1 or Set Length 2 barcode.
3. Turn to [Alpha-Numeric Pad](#) and scan the four digits (zero-padded) representing the length.



For Aztec labels, only the data characters are included in the length calculations.

NOTE

Any value set higher than 3700 will be considered to be 2710.

Scan the END barcode.

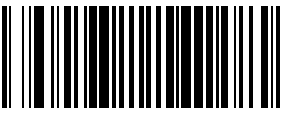
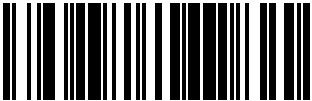
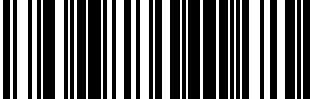
START / END	
PROGRAMMING BARCODES	
 DEFAULT SETTING FOR THIS FEATURE: 0001	Set Length 1
Set Length 2	 DEFAULT SETTING FOR THIS FEATURE: 2710

Composite Labels

Disable/Enable GS1 DataBar Omnidirectional 2D Component

When enabled, if a GS1 DataBar Omnidirectional label is decoded which has the 2D linkage flag set, the 2D component must also be decoded or the base label will be discarded.

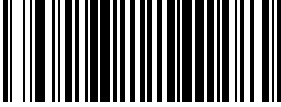
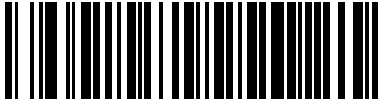
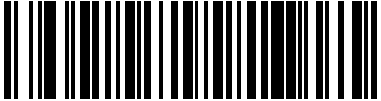

When disabled, only the GS1 DataBar Omnidirectional base label will be decoded and transmitted regardless of the state of the linkage flag.

START / END	
PROGRAMMING BARCODES	
	Disable GS1 DataBar Omnidirectional 2D Component DEFAULT
Enable GS1 DataBar Omnidirectional 2D Component	

Disable/Enable GS1 DataBar Expanded 2D Component

When enabled, if a GS1 DataBar Expanded label is decoded which has the 2D linkage flag set, the 2D component must also be decoded or the base label will be discarded.

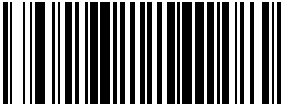

When disabled, only the GS1 DataBar Expanded base label will be decoded and transmitted regardless of the state of the linkage flag.

START / END	
PROGRAMMING BARCODES	
	Disable GS1 DataBar Expanded 2D Component DEFAULT
Enable GS1 DataBar Expanded 2D Component	

Disable/Enable GS1 DataBar Limited 2D Component

When enabled, if a GS1 DataBar Limited label is decoded which has the 2D linkage flag set, the 2D component must also be decoded or the base label will be discarded.

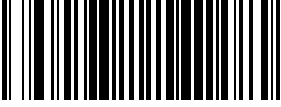
When disabled, only the GS1 DataBar Limited base label will be decoded and transmitted regardless of the state of the linkage flag.

START / END	
PROGRAMMING BARCODES	
	Disable GS1 DataBar Limited 2D Component DEFAULT
Enable GS1 DataBar Limited 2D Component	

NOTES

Advanced Decoding Features

Pharmacy Patterns

Enables/disables using the pharmacy patterns.

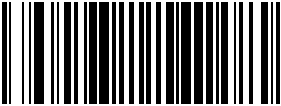
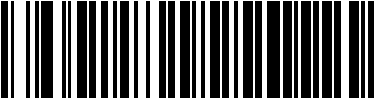
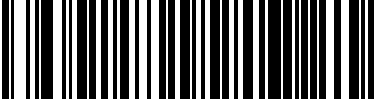
START / END	
PROGRAMMING BARCODES	
	Pharmacy Patterns = Disable DEFAULT
Pharmacy Patterns = Enable	

Inverse Label Reading

This controls the method of reading inverse labels (white label on black background).



This feature is only available for GS1 DataBar and 2D symbologies.

NOTE

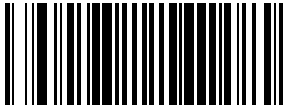
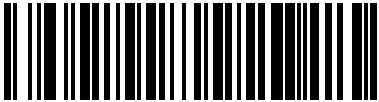
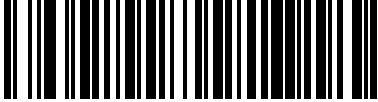
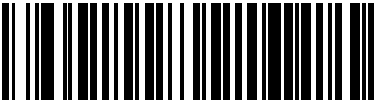
START / END	
PROGRAMMING BARCODES	
	2D Read Mode = Reads only normal labels DEFAULT
2D Read Mode = Reads both normal and inverse labels	
	2D Read Mode = Reads only inverse labels

Chapter A

Product Specifications

Optical and Read Performance Parameters

Parameter	Specification
Scan Volume	70 cubic inches
Scan Pattern	136 Scan Lines
Scan Rate	1,768 scan lines/second
Minimum Resolution	5 mil
Depth of Field (100% UPC Labels)	0 - 7"
Minimum Print Contrast Ratio	25%
Skew (Yaw)	$\pm 75^\circ$
Pitch	$\pm 65^\circ$
Roll	Between 0 and 360°

Scanner Dimensions

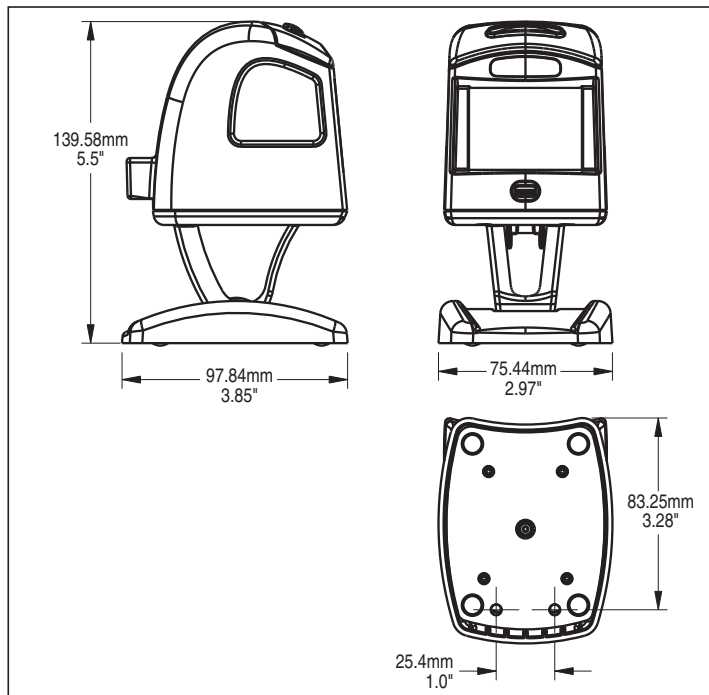

Physical Properties

Parameter	Specification
Dimensions (Scanner only):	3.3" x2.8" x3.7"
Dimensions (Scanner w/ Base Station):	5.5" x2.9" x3.8"
Weight (Scanner)	7.0 oz.
Weight (Base Station)	6.6 oz.

Electrical Parameters

Parameter	Specification
Operating Voltage	Input voltage 4.5 to 14 VDC
Input Current	
Operating (idle)	<300mA
Operating (label read)	<400 mA

Environmental Parameters

Parameter	Specification
Mechanical Shock	Multi 1.2m drops
Contaminants Water and Dust	IP52
Temperature Ranges:	
Operating	32° F to +104° F (0° C to +40° C)
Storage	-40° F to +158° F (-40° C to + 70° C)
Ambient Light Indoor	0 - 6000 lux
Ambient Light Outdoor	0 - 86,100 lux
Humidity	5 to 95% non-condensing
Beeper/Speaker	65-85dBA at a distance of 3'-3" (1 meter)
Vibration	Retail/Office

Other Parameters

Parameter	Specification
EAS Support	YES (Checkpoint)

Chapter B

Cable Pinouts

Standard Cable Pinouts (Primary Interface Cables)

RS-232

- 1
- 2 CTS
- 3
- 4 RTS
- 5 RXD
- 6 TXD
- 7
- 8 VCC IN
- 9 GND
- 10

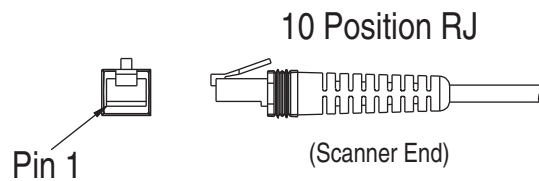

IBM Port 5B/9B/17

- 1
- 2
- 3
- 4 DATA -
- 5
- 6 DATA +
- 7
- 8 VCC_IN
- 9 GND
- 10

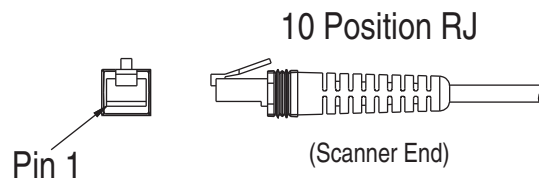

USB-OEM

- 1
- 2
- 3
- 4 D -
- 5
- 6 D +
- 7
- 8 VIN
- 9 GND
- 10

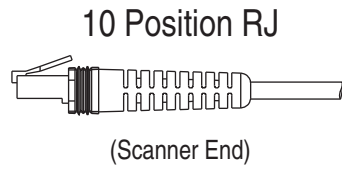
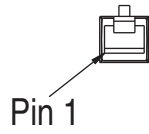

USB, USB Keyboard & USB COM

- 1
- 2
- 3
- 4 D -
- 5
- 6 D +
- 7
- 8 VBUS_VIN
- 9 GND
- 10

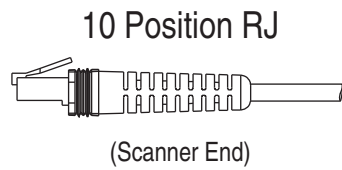
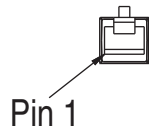

Keyboard Wedge

- 1
- 2 KB_DATA
- 3 AT_CLK
- 4 KB_CLK
- 5
- 6 AT_DATA
- 7
- 8 VCC_IN
- 9 GND
- 10

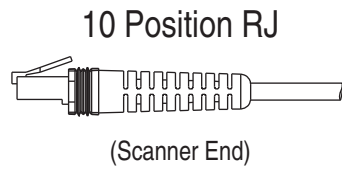
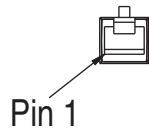

Chapter C

Alpha-Numeric Pad



A



B



C



D



E



F

Alpha-Numeric Pad



Appendix D

Default Settings

Defaults by Symbology

The following is a partial list of key settings for each symbology type.

Code Type	Read Enable	Checksum Verification Enable	Checksum Transmission Enable	Label ID
UPC-A	✓	✓	✓	A
UPC-E	✓	✓	✓	E
EAN-13	✓	✓	✓	F
EAN-8	✓	✓	✓	FF
GS1 DataBar Omnidirectional				R4
GS1 Expanded				RX
Code 39	✓		✓	*
PharmaCode 39				A
Code 128	✓			#
Interleaved 2 of 5			✓	i
Codabar			✓	%
Code 93				&
MSI/Plessey			✓	@
Standard 2 of 5			✓	s
PDF 417				P
Micro PDF 417				mP
Datamatrix				Dm
QR Code				QR
Maxicode				MC
Aztec				Az
GS1 DataBar Omnidirectional 2D Composite				R4
GS1 DataBar Expanded 2D Composite				RX
GS1 DataBar Limited 2D Composite				RL

Interface Default Exceptions

The factory default settings indicated in the programming sections (in bold text) reflect factory configuration for the RS-232 standard interface. The following tables list default exceptions by interface for the remaining available interfaces.

IBM Interfaces

IBM Interfaces include USB-OEM, IBM Port 9B, IBM Port5B and IBM Port17.

Parameter	Default Setting
IBM Interface Type	IBM Port 9B
Number of Host Transmit Buffers	One Buffer
Label I.D. Transmission	Disable
Suffix Characters	No Suffix

Interface Default Exceptions – continued

RS-232 Wincor/Nixdorf

Parameter	Default Setting
Interface Type	RS-232-WN
Number of Host Transmit Buffers	One Buffer
RS-232 Parity	Odd
RS-232 Hardware Control	CTS Flow Control
UPC-E Check Character Conversion	Disabled
UCC/EAN-128 Label ID	'P'
Code 39 Label ID	'M'
Code 93 Label ID	'L'
Code 128 Label ID	'K'
Codabar Label ID	'N'
EAN-8 Label ID	'B'
EAN-13 Label ID	'A'
ISBN Label ID	'A'
Interleaved 2 of 5 Label ID	'I'
Standard 2 of 5 Label ID	'H'
MSI/Plessey Label ID	'O'
UPC-E Label ID	'C'
GS1 DataBar Omnidirectional Label ID	'E'
GS1 Expanded Label ID	'E'

Interface Default Exceptions — continued

Keyboards

Keyboard interfaces include USB Keyboard and Keyboard Wedge A-J.

Parameter	Default Setting
Keyboard Wedge Interface Type	USB Keyboard
Label ID Transmission	Disable

Appendix E

Keyboard Function Key Mappings

Keyboard Model Cross Reference

Table E-1 summarizes the keyboard models, their defined protocol, scancode set, and some unique features. The remaining tables in this chapter provide the function key maps associated with each of the scancode sets.

Table E-1. Keyboard Model Cross Reference

Model Type	I/F ID	Transmission Protocol	Scancode Set	Func. Key Map Support	Use Country Mode
PC/XT Foreign ALT Mode	Wedge A	PC/XT	Scan Set 1	No	No
AT; PS/2 25-286; PS/2 30-286; PS/2 50, 50Z; PS/2 60,70,80,90,95 Foreign ALT Mode	Wedge B	AT/PS2	Scan Set 2	No	No
PS/2 25 and 30 Foreign ALT Mode	Wedge C	AT/PS2	Scan Set 1	No	No
PC/XT U.S. Mode	Wedge D	PC/XT	Scan Set 1	Yes	No
AT; PS/2 25-286; PS/2 30-286; PS/2 50, 50Z; PS/2 60,70,80,90,95 U.S. Mode + specific country support	Wedge E	AT/PS2	Scan Set 2	Yes	Yes
PS/2 25 and 30 U.S. Mode	Wedge F	AT/PS2	Scan Set 1	Yes	No
IBM 3xxx Terminals (122-key keyboard)	Wedge G	AT/PS2	Scan Set 3	Yes	No
IBM 3xxx Terminals (102-key keyboard)	Wedge H	AT/PS2	Scan Set 3	Yes	No
PS55 5530T with JAPANESE DOS (TDOS)	Wedge I	AT/PS2	Japanese DOS	Yes	No
NEC 9801	Wedge J	NEC 9801	NEC 9801	Yes	No

Table E-2. USB Function Key Usage Map

ASCII	Key value	Usage Name	Modifier/Scancode
00	NUL	ALT right Make	40h 00h
01	SOH	ALT right Break	00h 00h ¹
02	STX	F11	00h 44h
03	ETX	F12	00h 45h
04	EOT	GUI right Make	80h 00h
05	ENQ	GUI right Break	00h 00h ¹
06	ACK	CTRL right Make	10h 00h
07	BEL	CTRL right Break	00h 00h ¹
08	BS	BS	00h 2Ah
09	HT	TAB right	00h 2Bh
0A	LF	RIGHT arrow (inner keypad)	00h 4Fh
0B	VT	TAB left	02h 2Bh
0C	FF	Enter (right keypad)	00h 58h
0D	CR	CR	00h 28h
0E	SO	INSERT (inner keypad)	00h 49h
0F	SI	PAGE UP (inner keypad)	00h 4Bh
10	DLE	PAGE DOWN (inner keypad)	00h 4Eh
11	DC1	HOME (inner keypad)	00h 4Ah
12	DC2	LEFT arrow (inner keypad)	00h 50h
13	DC3	DOWN arrow (inner keypad)	00h 51h
14	DC4	UP arrow (inner keypad)	00h 52h
15	NAK	F6	00h 3Fh
16	SYN	F1	00h 3Ah
17	ETB	F2	00h 3Bh
18	CAN	F3	00h 3Ch
19	EM	F4	00h 3Dh
1A	SUB	F5	00h 3Eh
1B	ESC	ESC	00h 29h
1C	FS	F7	00h 40h
1D	GS	F8	00h 41h
1E	RS	F9	00h 42h
1F	US	F10	00h 43h

Table E-3. Scanset 1 Function Key Map

ASCII (hex)	ASCII code	Key	Scancode
00	NUL	ALT right Make	E0h 38h
01	SOH	ALT right Break	E0h B8h
02	STX	ALT left Make	38h
03	ETX	ALT left Break	B8h
04	EOT	CTRL left Make	1Dh
05	ENQ	CTRL left Break	9Dh
06	ACK	CTRL right Make	E0h 1Dh
07	BEL	CTRL right Break	E0h 9Dh
08	BS	BS	0Eh
09	HT	TAB right	0Fh
0A	LF	RIGHT arrow (inner keypad)	4Dh + E0
0B	VT	TAB left	0Fh + S
0C	FF	Enter (inner keypad)	1Ch + E0
0D	CR	CR	1Ch
0E	SO	INSERT (inner keypad)	52h + E0
0F	SI	PAGE UP (inner keypad)	49h + E0
10	DLE	PAGE DOWN (inner keypad)	51h + E0
11	DC1	HOME (inner keypad)	47h + E0
12	DC2	LEFT arrow (inner keypad)	4Bh + E0
13	DC3	DOWN arrow (inner keypad)	50h + E0
14	DC4	UP arrow (inner keypad)	48h + E0

Table E-4. Scanset 2 Function Key Map

ASCII (hex)	ASCII code	Key	Scancode
00	NUL	ALT right Make	E0h 11h
01	SOH	ALT right Break	E0h F0h 11h
02	STX	ALT left Make	11h
03	ETX	ALT left Break	F0h 11h
04	EOT	CTRL left Make	14h
05	ENQ	CTRL left Break	F0h 14h
06	ACK	CTRL right Make	E0h 14h
07	BEL	CTRL right Break	E0h F0h 14h
08	BS	BS	66h
09	HT	TAB right	0Dh
0A	LF	RIGHT arrow (inner keypad)	74h + E0
0B	VT	TAB left	0Dh + S
0C	FF	Enter (right keypad)	5Ah + E0
0D	CR	CR	5Ah
0E	SO	INSERT (inner keypad)	70h + E0
0F	SI	PAGE UP (inner keypad)	7Dh + E0
10	DLE	PAGE DOWN (inner keypad)	7Ah + E0
11	DC1	HOME (inner keypad)	6Ch + E0
12	DC2	LEFT arrow (inner keypad)	6Bh + E0
13	DC3	DOWN arrow (inner keypad)	72h + E0
14	DC4	UP arrow (inner keypad)	75h + E0
15	NAK	F6	0Bh
16	SYN	F1	05h
17	ETB	F2	06h
18	CAN	F3	04h

19	EM	F4	0Ch
1A	SUB	F5	03h
1B	ESC	ESC	76h
1C	FS	F7	83h
1D	GS	F8	0Ah
1E	RS	F9	01h
1F	US	F10	09h

Table E-5. Scanset 3, 102-Key Function Key Map

ASCII (hex)	ASCII code	Key	Scancode
00	NUL	ALT right Make	39h
01	SOH	ALT right Break	F0h 39h
02	STX	ALT left Make	19h
03	ETX	ALT left Break	F0h 19h
04	EOT	CTRL left Make	11h
05	ENQ	CTRL left Break	F0h 11h
06	ACK	CTRL right Make	58h
07	BEL	CTRL right Break	F0h 58h
08	BS	BS	66h
09	HT	TAB right	0Dh
0A	LF	RIGHT arrow (inner keypad)	6Ah
0B	VT	TAB left	0Dh + S
0C	FF	Enter (inner keypad)	79h
0D	CR	CR	5Ah
0E	SO	INSERT (inner keypad)	67h
0F	SI	PAGE UP (inner keypad)	6Fh
10	DLE	PAGE DOWN (inner keypad)	6Dh
11	DC1	HOME (inner keypad)	6Eh
12	DC2	LEFT arrow (inner keypad)	61h
13	DC3	DOWN arrow (inner keypad)	60h
14	DC4	UP arrow (inner keypad)	63h
15	NAK	F6	2Fh
16	SYN	F1	07h
17	ETB	F2	0Fh
18	CAN	F3	17h
19	EM	F4	1Fh
1A	SUB	F5	27h
1B	ESC	ESC	08h
1C	FS	F7	37h
1D	GS	F8	3Fh
1E	RS	F9	47h
1F	US	F10	4Fh

Table E-6. Scanset 3 122-Key Function Key Map

ASCII (hex)	ASCII code	Key	Scancode
00	NUL	ALT Right Make	39h
01	SOH	ALT Right Break	F0h 39h
02	STX	ALT left Make	19h
03	ETX	ALT left Break	F0h 19h
04	EOT	CTRL left (RESET) Make only	11h
05	ENQ	CTRL left (RESET) Make/Break	11h F0h 11h
06	ACK	ONLINE Enter Make only	58h
07	BEL	ONLINE Enter Make/Break	58h F0h 58h
08	BS	BS	66h
09	HT	TAB right	0Dh
0A	LF	RIGHT arrow (inner keypad)	6Ah
0B	VT	TAB left	0Dh + S
0C	FF	CR (FIELD EXIT) Make only	5Ah F0h 5Ah
0D	CR	CR (FIELD EXIT) Make/Break	5Ah
0E	SO	INSERT (inner keypad)	65h
0F	SI	FIELD +	79h
10	DLE	FIELD -	7Ch
11	DC1	HOME (inner keypad)	62h
12	DC2	LEFT arrow (inner keypad)	61h
13	DC3	DOWN arrow (inner keypad)	60h
14	DC4	UP arrow (inner keypad)	63h
15	NAK	F6	2Fh
16	SYN	F1	07h
17	ETB	F2	0Fh
18	CAN	F3	17h
19	EM	F4	1Fh
1A	SUB	F5	27h
1B	ESC	ESC	08h
1C	FS	F7	37h
1D	GS	F8	3Fh
1E	RS	F9	47h
1F	US	F10	4Fh

Table E-7. Japanese DOS Function Key Map

ASCII value	ASCII code	Key	Scancode
00h	NUL	ALT right Make	31h
01h	SOH	ALT right Break	B1h
02h	STX	ALT left Make	31h
03h	ETX	ALT left Break	B1h
04h	EOT	CTRL left Make	41h
05h	ENQ	CTRL left Break	C1h
06h	ACK	CTRL right Make	41h
07h	BEL	CTRL right Break	C1h
08h	BS	BS	3Eh
09h	HT	TAB right	3Ch
0Ah	LF	RIGHT arrow (inner keypad)	4Dh
0Bh	VT	TAB left	3Ch + S
0Ch	FF	Enter (right keypad)	60h
0Dh	CR	CR	3Bh
0Eh	SO	INSERT (inner keypad)	52h
0Fh	SI	PAGE UP (inner keypad)	49h
10h	DLE	PAGE DOWN (inner keypad)	51h
11h	DC1	HOME (inner keypad)	4Ch
12h	DC2	LEFT arrow (inner keypad)	4Bh
13h	DC3	DOWN arrow (inner keypad)	4Ah
14h	DC4	UP arrow (inner keypad)	4Eh
15h	NAK	F6	6Dh
16h	SYN	F1	68h
17h	ETB	F2	69h
18h	CAN	F3	6Ah
19h	EM	F4	6Bh
1Ah	SUB	F5	6Ch
1Bh	ESC	ESC	3Dh
1Ch	FS	F7	6Eh
1Dh	GS	F8	6Fh
1Eh	RS	F9	70h
1Fh	US	F10	71h

Table E-8. NEC 9801-Key Function Key Map

ASCII value	ASCII code	Key	Scancode
00h	NUL	unused	n/a
01h	SOH	CR	1Ch
02h	STX	CAPS LOCK ON (make)	71h
03h	ETX	CAPS LOCK OFF (break)	F1h
04h	EOT	CTRL left Make	74h
05h	ENQ	CTRL left Break	F4h
06h	ACK	CTRL-C	60h
07h	BEL	n/a	n/a
08h	BS	BS	0Eh
09h	HT	TAB right	0Fh
0Ah	LF	RIGHT arrow (inner keypad)	3Ch
0Bh	VT	TAB left	0Fh + S
0Ch	FF	DELETE	39h
0Dh	CR	CR	1Ch
0Eh	SO	INSERT (inner keypad)	38h
0Fh	SI	KATAKANA LOCK ON (Make)	72h
10h	DLE	KATAKANA LOCK OFF (Break)	F2h
11h	DC1	HOME (inner keypad)	3Eh
12h	DC2	LEFT arrow (inner keypad)	3Bh
13h	DC3	DOWN arrow (inner keypad)	3Dh
14h	DC4	UP arrow (inner keypad)	3Ah
15h	NAK	F6	67h
16h	SYN	F1	62h
17h	ETB	F2	63h
18h	CAN	F3	64h
19h	EM	F4	65h
1Ah	SUB	F5	66h
1Bh	ESC	ESC	00h
1Ch	FS	F7	68h
1Dh	GS	F8	69h
1Eh	RS	F9	6Ah
1Fh	US	F10	6Bh

NOTES

Chapter F

Host Commands

Accepting RS-232 Commands

The scanner responds to the following RS-232 commands:

COMMAND	ASCII	HEX	COMMENT
Enable Scanner	E	0x45	
Disable Scanner	D	0x44	
Reset Scanner	R	0x52	
Not On File Indication	F	0x46	Long series of beeps
Beep Good Read Tone	B	0x42	Beeps if Good Read Beep is enabled
Force Good Read Tone	!	0x01	Beeps regardless of beep setting
Bel	'	0x07	Force Good Read Tone
Identification request	i	0x69	Returns long response ^a
Health request	h	0x68	Returns long response ^a
Status request	s	0x73	Returns long response ^a

a. Call Tech Support for information.

If one of the above commands is received, the scanner will perform the steps indicated for the command. Host commands for other interfaces are also available. Contact Tech Support for more details.

NOTES

Chapter G

Sample Symbols

1D Symbol Samples

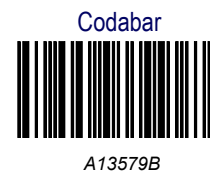
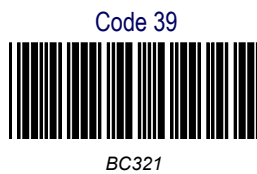
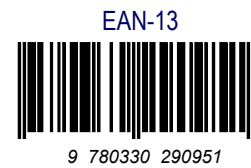
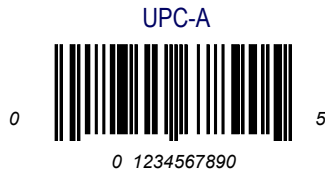

1D Symbol Samples — continued

Code 2 of 5

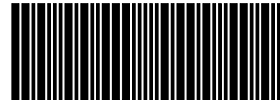

123456

GS1 DataBar Omnidirectional



(01)00123456789012

GS1 DataBar Expanded



0100123456789050

GS1 DataBar Limited

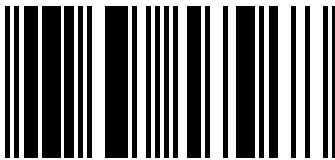

(01)16543210987654

2D Sample Symbols

PDF 417

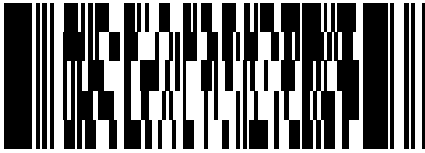

A12B3C

Micro PDF 417



BV17453

Datamatrix

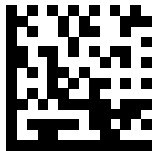

1314H17LL

QR Code

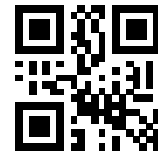

35900G9

Maxicode

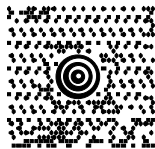

111TUVCCIUL7-1

Aztec



This is an Aztec Code

Composite Sample Symbols

GS1 DataBar Limited Composite

(17) 050923 (10) ABC123



(01) 0 4012345 67890 1

GS1 DataBar Truncated Composite

(17)050923(10)ABC123



(01) 09876543217899

NOTES

NOTES

ASCII Chart

ASCII Char.	Hex No.	ASCII Char.	Hex No.	ASCII Char.	Hex No.	ASCII Char.	Hex No.
NUL	00	SP	20	@	40	'	60
SOH	01	!	21	A	41	a	61
STX	02	"	22	B	42	b	62
ETX	03	#	23	C	43	c	63
EOT	04	\$	24	D	44	d	64
ENQ	05	%	25	E	45	e	65
ACK	06	&	26	F	46	f	66
BEL	07	'	27	G	47	g	67
BS	08	(28	H	48	h	68
HT	09)	29	I	49	i	69
LF	0A	*	2A	J	4A	j	6A
VT	0B	+	2B	K	4B	k	6B
FF	0C	,	2C	L	4C	l	6C
CR	0D	-	2D	M	4D	m	6D
SO	0E	.	2E	N	4E	n	6E
SI	0F	/	2F	O	4F	o	6F
DLE	10	0	30	P	50	p	70
DC1	11	1	31	Q	51	q	71
DC2	12	2	32	R	52	r	72
DC3	13	3	33	S	53	s	73
DC4	14	4	34	T	54	t	74
NAK	15	5	35	U	55	u	75
SYN	16	6	36	V	56	v	76
ETB	17	7	37	W	57	w	77
CAN	18	8	38	X	58	x	78
EM	19	9	39	Y	59	y	79
SUB	1A	:	3A	Z	5A	z	7A
ESC	1B	;	3B	[5B	{	7B
FS	1C	<	3C	\	5C		7C
GS	1D	=	3D]	5D	}	7D
RS	1E	>	3E	^	5E	~	7E
US	1F	?	3F	_	5F	DEL	7F



www.datalogic.com

© 2005-2016 Datalogic ADC, Inc. ■ All rights reserved. ■
Datalogic and the Datalogic logo are registered trademarks
of Datalogic S.p.A. in many countries, including the U.S.A.
and the E.U.

Datalogic ADC, Inc.

959 Terry Street | Eugene | OR 97402 | USA
Telephone: (1) 541-683-5700 | Fax: (1) 541-345-
7140



820034314

(Rev.G)

June 2016