



DS4208 Digital Scanner

Product Reference Guide



***DS4208 Digital Scanner
Product Reference Guide***

72E-139232-02

Revision A

April 2011

© 2011 Motorola Solutions, Inc. All rights reserved.

No part of this publication may be reproduced or used in any form, or by any electrical or mechanical means, without permission in writing from Motorola. This includes electronic or mechanical means, such as photocopying, recording, or information storage and retrieval systems. The material in this manual is subject to change without notice.

The software is provided strictly on an "as is" basis. All software, including firmware, furnished to the user is on a licensed basis. Motorola grants to the user a non-transferable and non-exclusive license to use each software or firmware program delivered hereunder (licensed program). Except as noted below, such license may not be assigned, sublicensed, or otherwise transferred by the user without prior written consent of Motorola. No right to copy a licensed program in whole or in part is granted, except as permitted under copyright law. The user shall not modify, merge, or incorporate any form or portion of a licensed program with other program material, create a derivative work from a licensed program, or use a licensed program in a network without written permission from Motorola. The user agrees to maintain Motorola's copyright notice on the licensed programs delivered hereunder, and to include the same on any authorized copies it makes, in whole or in part. The user agrees not to decompile, disassemble, decode, or reverse engineer any licensed program delivered to the user or any portion thereof.

Motorola reserves the right to make changes to any software or product to improve reliability, function, or design.

Motorola does not assume any product liability arising out of, or in connection with, the application or use of any product, circuit, or application described herein.

No license is granted, either expressly or by implication, estoppel, or otherwise under any Motorola, Inc., intellectual property rights. An implied license only exists for equipment, circuits, and subsystems contained in Motorola products.

MOTOROLA, MOTO, MOTOROLA SOLUTIONS and the Stylized M Logo are trademarks or registered trademarks of Motorola Trademark Holding, LLC and are used under license. All other trademarks are the property of their respective owners.

This media, or Motorola Product, may include Motorola Software, Commercial Third Party Software, and Publicly Available Software.

The Motorola Software that may be included on this media, or included in the Motorola Product, is Copyright (c) by Motorola, Inc., and its use is subject to the licenses, terms and conditions of the agreement in force between the purchaser of the Motorola Product and Motorola, Inc.

The Commercial Third Party Software that may be included on this media, or included in the Motorola Product, is subject to the licenses, terms and conditions of the agreement in force between the purchaser of the Motorola Product and Motorola, Inc., unless a separate Commercial Third Party Software License is included, in which case, your use of the Commercial Third Party Software will then be governed by the separate Commercial Third Party License.

The Publicly Available Software that may be included on this media, or in the Motorola Product, is listed below. The use of the listed Publicly Available Software is subject to the licenses, terms and conditions of the agreement in force between the purchaser of the Motorola Product and Motorola, Inc., as well as, the terms and conditions of the license of each Publicly Available Software package. Copies of the licenses for the listed Publicly Available Software, as well as, all attributions, acknowledgements, and software information details, are included below. Motorola is required to reproduce the software licenses, acknowledgments and copyright notices as provided by the Authors and Owners, thus, all such information is provided in its native language form, without modification or translation.

The Publicly Available Software in the list below is limited to the Publicly Available Software included by Motorola. The Publicly Available Software included by Commercial Third Party Software or Products, that is used in the Motorola Product, are disclosed in the Commercial Third Party Licenses, or via the respective Commercial Third Party Publicly Available Software Legal Notices.

Publicly available software list:

Name:	Regular Expression Evaluator
Version:	8.3
Description:	Compiles and executes regular expressions
Software Site:	http://www.freebsd.org/cgi/cvsweb.cgi/src/lib/libc/regex/
Source Code:	No Source Distribution Obligations. Motorola will not provide nor distribute the Source Code for the Regular Expression Evaluator.
License:	BSD Style License

© 1992 Henry Spencer.

© 1992, 1993 The Regents of the University of California. All rights reserved.

This code is derived from software contributed to Berkeley by Henry Spencer of the University of Toronto. Redistribution and use in source and binary forms, with or without modification, are permitted provided that the following conditions are met:

1. Redistributions of source code must retain the above copyright notice, this list of conditions and the following disclaimer.
2. Redistributions in binary form must reproduce the above copyright notice, this list of conditions and the following disclaimer in the documentation and/or other materials provided with the distribution.

3. All advertising materials mentioning features or use of this software must display the following acknowledgement:

This product includes software developed by the University of California, Berkeley and its contributors.

4. Neither the name of the University nor the names of its contributors may be used to endorse or promote products derived from this software without specific prior written permission.

THIS SOFTWARE IS PROVIDED BY THE REGENTS AND CONTRIBUTORS "AS IS" AND ANY EXPRESS OR IMPLIED WARRANTIES, INCLUDING, BUT NOT LIMITED TO, THE IMPLIED WARRANTIES OF MERCHANTABILITY AND FITNESS FOR A PARTICULAR PURPOSE ARE DISCLAIMED. IN NO EVENT SHALL THE REGENTS OR CONTRIBUTORS BE LIABLE FOR ANY DIRECT, INDIRECT, INCIDENTAL, SPECIAL, EXEMPLARY, OR CONSEQUENTIAL DAMAGES (INCLUDING, BUT NOT LIMITED TO, PROCUREMENT OF SUBSTITUTE GOODS OR SERVICES; LOSS OF USE, DATA, OR PROFITS; OR BUSINESS INTERRUPTION) HOWEVER CAUSED AND ON ANY THEORY OF LIABILITY, WHETHER IN CONTRACT, STRICT LIABILITY, OR TORT (INCLUDING NEGLIGENCE OR OTHERWISE) ARISING IN ANY WAY OUT OF THE USE OF THIS SOFTWARE, EVEN IF ADVISED OF THE POSSIBILITY OF SUCH DAMAGE.

Motorola Solutions, Inc.
One Motorola Plaza
Holtsville, New York 11742-1300
<http://www.motorolasolutions.com>.

Warranty

For the complete Motorola Solutions hardware product warranty statement, go to:
<http://www.motorola.com/enterprisemobility/warranty>.

Revision History

Changes to the original manual are listed below:

Change	Date	Description
-01 Rev A	02/2011	Initial release.
-02 Rev A	04/2011	Added GS1 DataBar Limited Security Level.

Table of Contents

Warranty	iii
Revision History	iv

About This Guide

Introduction	xiii
Configurations	xiii
Chapter Descriptions	xiv
Notational Conventions	xv
Related Documents	xv
Service Information	xvi

Chapter 1: Getting Started

Introduction	1-1
Interfaces	1-2
Unpacking	1-2
Setting Up the Digital Scanner	1-3
Installing the Interface Cable	1-3
Removing the Interface Cable	1-4
Connecting Power (if required)	1-4
Configuring the Digital Scanner	1-4
Accessories	1-5

Chapter 2: Scanning

Introduction	2-1
Beeper Definitions	2-2
LED Definitions	2-4
Scanning	2-5
Scanning in Hands-Free (Presentation) Mode	2-5
Assemble the Stand	2-5
Scanning with Intellistand	2-6
Scanning in Hand-Held Mode	2-7
Aiming	2-7
Decode Ranges	2-9

Chapter 3: Maintenance, Troubleshooting & Technical Specifications

Introduction	3-1
Maintenance	3-1
Troubleshooting	3-2
Technical Specifications	3-5
Digital Scanner Signal Descriptions	3-7

Chapter 4: User Preferences & Miscellaneous Digital Scanner Options

Introduction	4-1
Scanning Sequence Examples	4-2
Errors While Scanning	4-2
Parameter Defaults	4-2
User Preferences	4-4
Set Default Parameter	4-4
Parameter Bar Code Scanning	4-5
Beeper Preferences	4-5
Beep After Good Decode	4-5
Beeper Tone	4-6
Beeper Volume	4-7
Beeper Duration	4-7
Suppress Power-up Beeps	4-8
Low Power Mode	4-8
Time Delay to Low Power Mode	4-9
Hand-Held Trigger Mode	4-11
Picklist Mode	4-12
Continuous Bar Code Read	4-13
Unique Bar Code Reporting	4-13
Decode Session Timeout	4-14
Timeout Between Decodes, Same Symbol	4-14
Timeout Between Decodes, Different Symbols	4-15
Fuzzy 1D Processing	4-15
Decode Mirror Images (Data Matrix Only)	4-16
Mobile Phone/Display Mode	4-17
PDF Prioritization	4-18
PDF Prioritization Timeout	4-18
Hand-Held Decode Aiming Pattern	4-19
Hands-Free Decode Aiming Pattern	4-20
Presentation Mode Field of View	4-21
Decoding Illumination (Hand-held Mode only)	4-22
Multicode Mode	4-22
Multicode Expression	4-23
Multicode Expression Syntax: [n] [Element 1]; [Element 2]; ... [Element n]; ...	4-23
Notes	4-24
Example 1	4-25
Example 2a	4-26
Example 2b	4-26
Example 3	4-27
Multicode Mode Concatenation	4-28
Multicode Concatenation Symbology	4-29

Multicode Troubleshooting	4-30
Troubleshooting Multicode Expression Programming	4-30
Troubleshooting Multicode Mode Scanning and Decoding	4-30
Examples of Simple Multicode Expressions	4-31
Miscellaneous Scanner Parameters	4-32
Transmit Code ID Character	4-32
Prefix/Suffix Values	4-33
Scan Data Transmission Format	4-34
FN1 Substitution Values	4-35
Transmit “No Read” Message	4-36

Chapter 5: USB Interface

Introduction	5-1
Connecting a USB Interface	5-2
USB Parameter Defaults	5-3
USB Host Parameters	5-5
USB Device Type	5-5
Symbol Native API (SNAPI) Status Handshaking	5-6
USB Country Keyboard Types - Country Codes	5-7
USB Keystroke Delay	5-9
Simulated Caps Lock	5-10
USB CAPS Lock Override	5-10
USB Ignore Unknown Characters	5-11
USB Convert Unknown to Code 39	5-11
USB Ignore Beep Directive	5-12
USB Ignore Type Directive	5-12
Emulate Keypad	5-13
Emulate Keypad with Leading Zero	5-13
USB Keyboard FN 1 Substitution	5-14
Function Key Mapping	5-14
Convert Case	5-15
USB Static CDC	5-15
USB Polling Interval	5-16
Quick Keypad Emulation	5-18
ASCII Character Set for USB	5-19

Chapter 6: RS-232 Interface

Introduction	6-1
Connecting an RS-232 Interface	6-2
RS-232 Parameter Defaults	6-3
RS-232 Host Parameters	6-4
RS-232 Host Types	6-6
Baud Rate	6-8
Parity	6-9
Stop Bit Select	6-10
Data Bits	6-10
Check Receive Errors	6-11
Hardware Handshaking	6-11

Software Handshaking	6-13
Host Serial Response Time-out	6-15
RTS Line State	6-16
Beep on <BEL>	6-16
Intercharacter Delay	6-17
Nixdorf Beep/LED Options	6-18
Ignore Unknown Characters	6-18
ASCII Character Set for RS-232	6-19

Chapter 7: IBM 468X / 469X Interface

Introduction	7-1
Connecting to an IBM 468X/469X Host	7-2
IBM Parameter Defaults	7-3
IBM 468X/469X Host Parameters	7-4
Port Address	7-4
Convert Unknown to Code 39	7-5
Ignore Beep Directive	7-5
Ignore Configuration Directive	7-6

Chapter 8: Keyboard Wedge Interface

Introduction	8-1
Connecting a Keyboard Wedge Interface	8-2
Keyboard Wedge Parameter Defaults	8-3
Keyboard Wedge Host Parameters	8-4
Keyboard Wedge Host Types	8-4
Keyboard Wedge Country Types - Country Codes	8-5
Ignore Unknown Characters	8-7
Keystroke Delay	8-7
Intra-Keystroke Delay	8-8
Alternate Numeric Keypad Emulation	8-8
Simulated Caps Lock	8-9
Caps Lock Override	8-9
Convert Wedge Case	8-10
Function Key Mapping	8-10
FN1 Substitution	8-11
Send Make and Break	8-11
Keyboard Maps	8-12
ASCII Character Set for Keyboard Wedge	8-13

Chapter 9: Symbologies

Introduction	9-1
Scanning Sequence Examples	9-1
Errors While Scanning	9-2
Symbology Parameter Defaults	9-2
Disable All Code Types	9-7
UPC/EAN	9-8
Enable/Disable UPC-A	9-8

Enable/Disable UPC-E	9-8
Enable/Disable UPC-E1	9-9
Enable/Disable EAN-8/JAN-8	9-9
Enable/Disable EAN-13/JAN-13	9-10
Enable/Disable Bookland EAN	9-10
Bookland ISBN Format	9-11
Decode UPC/EAN/JAN Supplementals	9-12
User-Programmable Supplementals	9-15
UPC/EAN/JAN Supplemental Redundancy	9-15
UPC/EAN/JAN Supplemental AIM ID Format	9-16
Transmit UPC-A Check Digit	9-17
Transmit UPC-E Check Digit	9-17
Transmit UPC-E1 Check Digit	9-18
UPC-A Preamble	9-18
UPC-E Preamble	9-19
UPC-E1 Preamble	9-20
Convert UPC-E to UPC-A	9-21
Convert UPC-E1 to UPC-A	9-21
EAN-8/JAN-8 Extend	9-22
UCC Coupon Extended Code	9-22
Coupon Report	9-23
ISSN EAN	9-24
Code 128	9-25
Enable/Disable Code 128	9-25
Set Lengths for Code 128	9-25
Enable/Disable GS1-128 (formerly UCC/EAN-128)	9-26
Enable/Disable ISBT 128	9-27
ISBT Concatenation	9-28
Check ISBT Table	9-29
ISBT Concatenation Redundancy	9-29
Code 39	9-30
Enable/Disable Code 39	9-30
Enable/Disable Trioptic Code 39	9-30
Convert Code 39 to Code 32	9-31
Code 32 Prefix	9-31
Set Lengths for Code 39	9-32
Code 39 Check Digit Verification	9-33
Transmit Code 39 Check Digit	9-33
Code 39 Full ASCII Conversion	9-34
Code 39 Buffering - Scan & Store	9-35
Buffer Data	9-35
Clear Transmission Buffer	9-35
Transmit Buffer	9-36
Overfilling Transmission Buffer	9-36
Attempt to Transmit an Empty Buffer	9-36
Code 93	9-37
Enable/Disable Code 93	9-37
Set Lengths for Code 93	9-37
Code 11	9-39
Code 11	9-39

Set Lengths for Code 11	9-39
Code 11 Check Digit Verification	9-41
Transmit Code 11 Check Digits	9-42
Interleaved 2 of 5 (ITF)	9-42
Enable/Disable Interleaved 2 of 5	9-42
Set Lengths for Interleaved 2 of 5	9-43
I 2 of 5 Check Digit Verification	9-45
Transmit I 2 of 5 Check Digit	9-45
Convert I 2 of 5 to EAN-13	9-46
Discrete 2 of 5 (DTF)	9-46
Enable/Disable Discrete 2 of 5	9-46
Set Lengths for Discrete 2 of 5	9-47
Codabar (NW - 7)	9-49
Enable/Disable Codabar	9-49
Set Lengths for Codabar	9-49
CLSI Editing	9-51
NOTIS Editing	9-51
MSI	9-52
Enable/Disable MSI	9-52
Set Lengths for MSI	9-52
MSI Check Digits	9-54
Transmit MSI Check Digit(s)	9-54
MSI Check Digit Algorithm	9-55
Chinese 2 of 5	9-55
Enable/Disable Chinese 2 of 5	9-55
Matrix 2 of 5	9-56
Enable/Disable Matrix 2 of 5	9-56
Set Lengths for Matrix 2 of 5	9-57
Matrix 2 of 5 Check Digit	9-58
Transmit Matrix 2 of 5 Check Digit	9-58
Korean 3 of 5	9-59
Enable/Disable Korean 3 of 5	9-59
Inverse 1D	9-60
Postal Codes	9-61
US Postnet	9-61
US Planet	9-61
Transmit US Postal Check Digit	9-62
UK Postal	9-62
Transmit UK Postal Check Digit	9-63
Japan Postal	9-63
Australia Post	9-64
Australia Post Format	9-65
Netherlands KIX Code	9-66
USPS 4CB/One Code/Intelligent Mail	9-66
UPU FICS Postal	9-67
GS1 DataBar	9-68
GS1 DataBar	9-68
GS1 DataBar Limited	9-69
GS1 DataBar Limited Security Level	9-70
GS1 DataBar Expanded	9-71

Convert GS1 DataBar to UPC/EAN	9-72
Composite	9-73
Composite CC-C	9-73
Composite CC-A/B	9-73
Composite TLC-39	9-74
UPC Composite Mode	9-74
Composite Beep Mode	9-75
GS1-128 Emulation Mode for UCC/EAN Composite Codes	9-75
2D Symbolologies	9-76
Enable/Disable PDF417	9-76
Enable/Disable MicroPDF417	9-76
Code 128 Emulation	9-77
Data Matrix	9-78
Data Matrix Inverse	9-78
Maxicode	9-79
QR Code	9-79
QR Inverse	9-80
MicroQR	9-80
Aztec	9-81
Aztec Inverse	9-81
Redundancy Level	9-82
Redundancy Level 1	9-82
Redundancy Level 2	9-82
Redundancy Level 3	9-82
Redundancy Level 4	9-83
Security Level	9-84
Intercharacter Gap Size	9-85
Macro PDF Features	9-86
Flush Macro Buffer	9-86
Abort Macro PDF Entry	9-86
Chapter 10: 123Scan2	
Introduction	10-1
Communication with 123Scan2	10-1
123Scan2 Requirements	10-1
Chapter 11: Advanced Data Formatting	
Introduction	11-1
Appendix A: Standard Default Parameters	
Appendix B: Programming Reference	
Symbol Code Identifiers	B-1
AIM Code Identifiers	B-3

Appendix C: Sample Bar Codes

Code 39	C-1
UPC/EAN	C-1
UPC-A, 100%	C-1
EAN-13, 100%	C-2
Code 128	C-2
Interleaved 2 of 5	C-2
GS1 DataBar-14	C-3
PDF417	C-3
Data Matrix	C-3
Maxicode	C-3
QR Code	C-4
US Postnet	C-4
UK Postal	C-4

Appendix D: Numeric Bar Codes

Numeric Bar Codes	D-1
Cancel	D-2

Appendix E: ASCII Character Sets

Index

Glossary

Tell us what you think...

About This Guide

Introduction

The *DS4208 Product Reference Guide* provides general instructions for setting up, operating, maintaining, and troubleshooting the DS4208 digital scanner.

Configurations

This guide includes the following DS4208 digital scanner configurations:

- DS4208-SR00001WR DS4208 Digital Scanner, Standard Range, Cash Register White
- DS4208-SR00007WR DS4208 Digital Scanner, Standard Range, Twilight Black

Chapter Descriptions

Topics covered in this guide are as follows:

- [Chapter 1, Getting Started](#) provides a product overview, unpacking instructions, and cable connection information.
- [Chapter 2, Scanning](#) describes parts of the digital scanner, beeper and LED definitions, and how to use the scanner in hand-held and hands-free (presentation) modes.
- [Chapter 3, Maintenance, Troubleshooting & Technical Specifications](#) provides information on how to care for the digital scanner, troubleshooting, and technical specifications.
- [Chapter 4, User Preferences & Miscellaneous Digital Scanner Options](#) describes features frequently used to customize how data transmits to the host device and programming bar codes for selecting user preference features for the digital scanner.
- [Chapter 5, USB Interface](#) describes how to set up the digital scanner with a USB host.
- [Chapter 6, RS-232 Interface](#) describes how to set up the digital scanner with an RS-232 host, such as point-of-sale devices, host computers, or other devices with an available RS-232 port.
- [Chapter 7, IBM 468X / 469X Interface](#) describes how to set up the digital scanner with IBM 468X/469X POS systems.
- [Chapter 8, Keyboard Wedge Interface](#) describes how to set up a Keyboard Wedge interface with the digital scanner.
- [Chapter 9, Symbologies](#) describes all symbology features and provides programming bar codes for selecting these features for the digital scanner.
- [Chapter 10, 123Scan2](#) describes this PC-based scanner configuration tool which enables rapid and easy customized setup of scanners.
- [Chapter 11, Advanced Data Formatting](#) briefly describes ADF, a means of customizing data before transmission to the host device, and includes a reference to the *ADF Programmer Guide*.
- [Appendix A, Standard Default Parameters](#) provides a table of all host devices and miscellaneous scanner defaults.
- [Appendix B, Programming Reference](#) provides a table of AIM code identifiers, ASCII character conversions, and keyboard maps.
- [Appendix C, Sample Bar Codes](#) includes sample bar codes of various code types.
- [Appendix D, Numeric Bar Codes](#) includes the numeric bar codes to scan for parameters requiring specific numeric values.
- [Appendix E, ASCII Character Sets](#) provides ASCII character value tables.

Notational Conventions

The following conventions are used in this document:

- *Italics* are used to highlight the following:
 - Chapters and sections in this and related documents
 - Dialog box, window and screen names
 - Drop-down list and list box names
 - Check box and radio button names
- **Bold** text is used to highlight the following:
 - Key names on a keypad
 - Button names on a screen.
- bullets (•) indicate:
 - Action items
 - Lists of alternatives
 - Lists of required steps that are not necessarily sequential
- Sequential lists (e.g., those that describe step-by-step procedures) appear as numbered lists.
- Throughout the programming bar code menus, asterisks (*) are used to denote default parameter settings.



* Indicates Default — * Baud Rate 9600 — Feature/Option

Related Documents

- *DS4208 Quick Start Guide*, p/n 72-139230-xx - provides general information for getting started with the DS4208 digital scanner, and includes basic set up and operation instructions.
- *Advanced Data Formatting Programmer Guide*, p/n 72E-69680-xx - provides information on ADF, a means of customizing data before transmission to a host.

For the latest version of this guide and all guides, go to: <http://supportcentral.motorola.com>.

Service Information

If you have a problem with your equipment, contact Motorola Solutions support for your region. Contact information is available at: <http://supportcentral.motorola.com>.

When contacting support, please have the following information available:

- Serial number of the unit
- Model number or product name
- Software type and version number

Motorola responds to calls by e-mail, telephone or fax within the time limits set forth in service agreements.

If your problem cannot be solved by Motorola Solutions Support, you may need to return your equipment for servicing and will be given specific directions. Motorola is not responsible for any damages incurred during shipment if the approved shipping container is not used. Shipping the units improperly can possibly void the warranty.

If you purchased your Motorola business product from a Motorola business partner, please contact that business partner for support.

Chapter 1 Getting Started

Introduction

The DS4208 combines superior 1D and 2D omnidirectional bar code scanning and transfer with a light-weight, hands-free/hand-held design. The digital scanner's Intellistand seamlessly accommodates both counter-top and hand-held use. Whether in hands-free (presentation) or hand-held mode, the digital scanner ensures comfort and ease of use for extended periods of time.

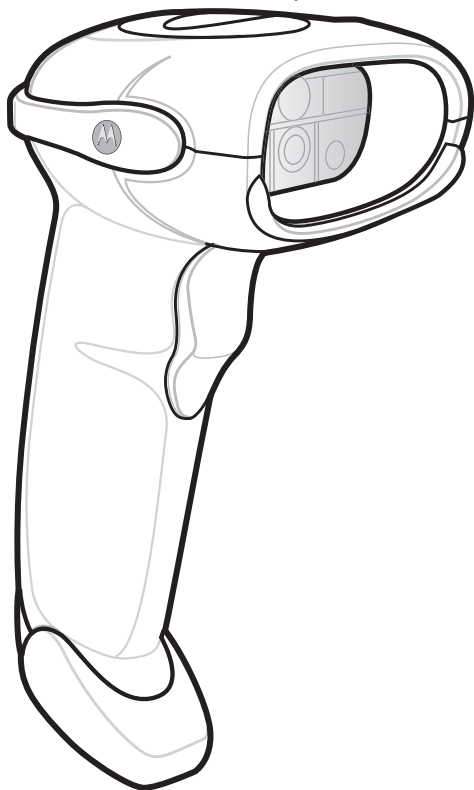

Figure 1-1 *DS4208 Digital Scanner*

Interfaces

The DS4208 digital scanner supports:

- USB connection to a host. The digital scanner autodetects a USB host and defaults to the HID keyboard interface type. Select other USB interface types by scanning programming bar code menus. This interface supports the following international keyboards (for Windows® environment): North America, German, French, French Canadian, Spanish, Italian, Swedish, UK English, Portuguese-Brazilian, and Japanese.
- Standard RS-232 connection to a host. Scan bar code menus to set up communication of the digital scanner with the host.
- Connection to IBM 468X/469X hosts. Scan bar code menus to set up communication of the digital scanner with the IBM terminal.
- Keyboard Wedge connection to a host. The host interprets scanned data as keystrokes. Scan bar code menus to set up communication of the digital scanner with the host. This interface supports the following international keyboards (for Windows® environment): North America, German, French International, French Canadian, French Belgian, Spanish, Italian, Swedish, UK English, Brazilian-Portuguese and Japanese.
- Configuration via 123Scan².

Unpacking

Remove the digital scanner from its packing and inspect it for damage. If the scanner was damaged in transit, contact Motorola Solutions Support. See [page xvi](#) for information. **KEEP THE PACKING.** It is the approved shipping container; use this to return the equipment for servicing.

Setting Up the Digital Scanner

Installing the Interface Cable

1. Insert the interface cable modular connector into the interface cable port on the rear of the digital scanner until an audible click sounds. Low/medium/high beeps sound, indicating the scanner is operational.

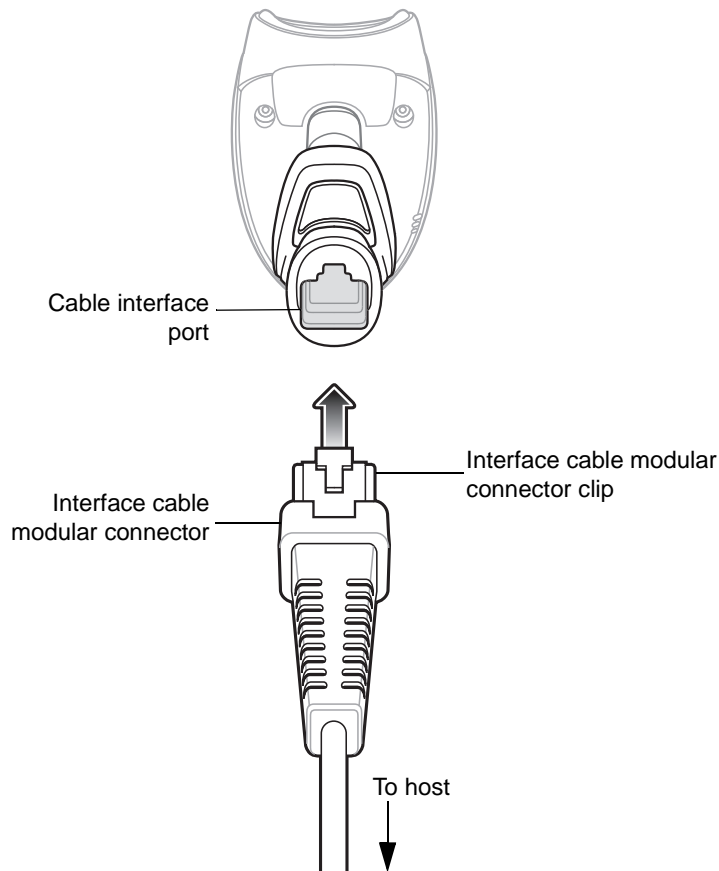

Figure 1-2 *Installing the Cable*



IMPORTANT Insert the cable into the cable interface port until an audible click sounds.

When connecting the DS4208 using a USB cable, a shielded connector cable is required (e.g., p/n CBA-U21-S07ZAR). If upgrading an LS2208 or LS4208 to a DS4208, use the shielded connector cable.

2. Gently tug the cable to ensure the connector is secure.
3. Connect the other end of the interface cable to the host (see the specific host chapter for information on host connections).

Removing the Interface Cable

1. Press the cable's modular connector clip through the access slot in the digital scanner's base.

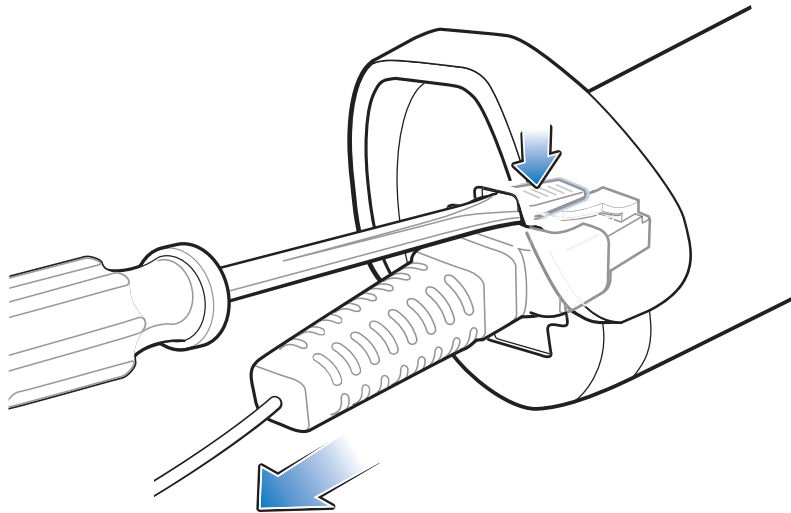

Figure 1-3 *Removing the Cable*

2. Carefully slide out the cable.
3. Follow the steps for [Installing the Interface Cable](#) to connect a new cable.

Connecting Power (if required)

If the host does not provide power to the digital scanner, connect an external power supply.

1. Plug the power supply into the power jack on the interface cable.
2. Plug the other end of the power supply into an AC outlet.

Configuring the Digital Scanner

To configure the digital scanner use the bar codes included in this manual, or use the 123Scan² configuration program. See [Chapter 4, User Preferences & Miscellaneous Digital Scanner Options](#), and [Chapter 9, Symbologies](#) for information about programming the digital scanner using bar code menus. See [Chapter 10, 123Scan2](#) for information on using this configuration program. Also see each host-specific chapter to set up connection to a specific host type.

Accessories

The digital scanner ships with the *DS4208 Quick Start Guide*. The following required accessories must be ordered:

- Interface cable for the appropriate interface.
- Shielded connector cable (e.g., p/n CBA-U21-S07ZAR) when connecting via USB. Refer to Solution Builder for guidance about cables.

✓ **NOTE** If upgrading an LS2208 or LS4208 to a DS4208, the shielded connector cable must be used.

- Universal power supply, if the interface requires this.

For additional items, contact a local Motorola representative or business partner.

Chapter 2 Scanning

Introduction

This chapter provides beeper and LED definitions, techniques involved in scanning bar codes, general instructions and tips about scanning, and decode zone diagrams.

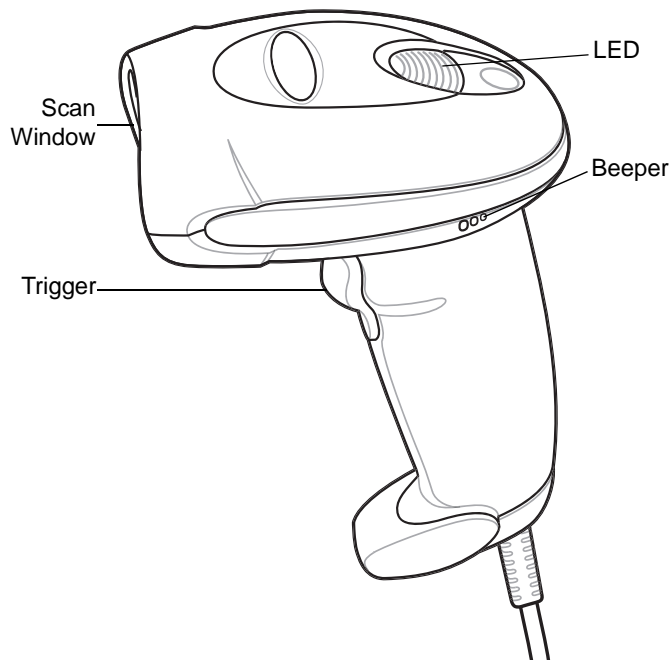

Figure 2-1 *Parts*

Beeper Definitions

The digital scanner issues different beep sequences and patterns to indicate status. [Table 2-1](#) defines beep sequences that occur during both normal scanning and while programming the digital scanner.

Table 2-1 *Beeper Definitions*

Beeper Sequence	Indication
Standard Use	
Low/medium/high beeps	Power up.
Short beep, tone programmable	A bar code symbol was decoded (if decode beeper is enabled).
4 long low beeps	Transmission error.
5 low beeps	Conversion or format error.
Low/low/low/extra low beeps	RS-232 receive error.
High beep	The digital scanner detected a <BEL> character over RS-232.
Parameter Menu Scanning	
Low/high beeps	Input error; incorrect bar code, programming sequence, or Cancel scanned.
High/low beeps	Keyboard parameter selected. Enter value using numeric bar codes.
High/low/high/low beeps	Successful program exit with change in parameter setting.
ADF Programming	
Low/low beeps	Enter another alphabetic character or scan the End of Message bar code.
Low/high/high beeps	All rules are deleted.
Low/high/low/high beeps	Out of rule memory. Erase some existing rules, then try to save rule again.
Low/high/low beeps	Cancel rule entry. Rule entry mode exited because of an error or the user asked to exit rule entry.
Low/high beeps	Entry error, wrong bar code scanned, or criteria/action list is too long for a rule. Re-enter criterion or action.
Low beep	Delete last saved rule. The current rule is left intact.
High/high beeps	ADF criteria or action is expected. Enter another criterion or action, or scan the Save Rule bar code.
High/low/low beeps	All criteria or actions cleared for current rule, continue entering rule.
High/low/high/low beeps	Rule saved. Rule entry mode exited.
Code 39 Buffering	
Low/high/low beeps	The Code 39 buffer was erased or there was an attempt to clear or transmit an empty buffer.
High/low beeps	New Code 39 data was entered into the buffer.

Table 2-1 *Beeper Definitions (Continued)*

Beeper Sequence	Indication
3 long high beeps	Code 39 buffer is full.
High/low/high beeps	The Code 39 buffer was erased.
Low/high beeps	A successful transmission of buffered data.
Macro PDF	
2 low beeps	MPDF sequence buffered.
2 long low beeps	File ID error. A bar code not in the current MPDF sequence was scanned.
3 long low beeps	Out of memory. There is not enough buffer space to store the current MPDF symbol.
4 long low beeps	Bad symbology. Scanned a 1D or 2D bar code in a MPDF sequence, a duplicate MPDF label, a label in an incorrect order, or trying to transmit an empty or illegal MPDF field.
5 long low beeps	Flushing MPDF buffer.
Low/high beeps	Flushing an already empty MPDF buffer.
Fast warble beep	Aborting MPDF sequence.
Host Specific	
USB only	
Low/medium/high beeps upon scanning a USB device type	Communication with the host must be established before the digital scanner can operate at the highest power level.
Low/medium/high beeps occur more than once	The USB host can put the digital scanner in a state where power to the scanner is cycled on and off more than once. This is normal and usually happens when the PC cold boots.
RS-232 only	
1 short high beep	A <BEL> character is received and Beep on <BEL> is enabled.

LED Definitions

In addition to beep sequences, the digital scanner uses a two-color LED to indicate status. [Table 2-2](#) defines LED colors that display during scanning.

Table 2-2 Standard LED Definitions

LED	Indication
Hand-Held Scanning Standard Use	
Green	A bar code was successfully decoded.
Red	Transmission error, conversion or format error, or RS-232 receive error.
Off	No power is applied to the digital scanner, or the scanner is on and ready to scan.
Hands-Free (Presentation) Scanning Standard Use	
Green	The scanner is on and ready to scan.
Momentarily Off	A bar code was successfully decoded.
Red	Transmission error, conversion or format error, or RS-232 receive error.
Off	No power is applied to the digital scanner, or the scanner is in low power mode.
Parameter Programming	
Green	Number expected. Enter value using numeric bar codes. Successful program exit with change in parameter setting.
Red	Input error: incorrect bar code, programming sequence, or Cancel scanned.
Firmware Update	
Red, alternating between solid and fast blinking	Firmware download is completing (user should wait for this indicator to complete before using the scanner). This indicator is followed by a low/medium/high power up beep.
ADF Programming	
Green	Enter another digit. Add leading zeros to the front if necessary. Enter another alphabetic character or scan the End of Message bar code. All criteria or actions cleared for current rule, continue entering rule. Delete last saved rule. The current rule is left intact. All rules deleted.
Blinking Green	Enter another criterion or action, or scan the Save Rule bar code.
Green after Blinking	Rule saved. Rule entry mode exited. Cancel rule entry. Rule entry mode exited because of an error or the user asked to exit rule entry.
Red	Out of rule memory. Erase some existing rules, then try to save rule again. Entry error, wrong bar code scanned, or criteria/action list is too long for a rule. Re-enter criterion or action.

Scanning

The digital scanner is in hands-free (presentation) mode when it is placed in the Intellistand. In this mode, the digital scanner operates in continuous (constant-on) mode, where it automatically decodes a bar code presented in its field of view.

When the digital scanner is not used for a user-definable period of time, it enters a low power mode in which the LEDs are turned off or blinked illuminated at a low duty cycle until the digital scanner detects an image change (e.g. motion).

Scanning in Hands-Free (Presentation) Mode

The optional Intellistand adds greater flexibility to scanning operation. When the scanner is seated in the stand's "cup," the scanner's built-in sensor places the scanner in hands-free mode. When the scanner is removed from the stand, it automatically switches modes to operate in its normal hand-held triggered mode.

Assemble the Stand

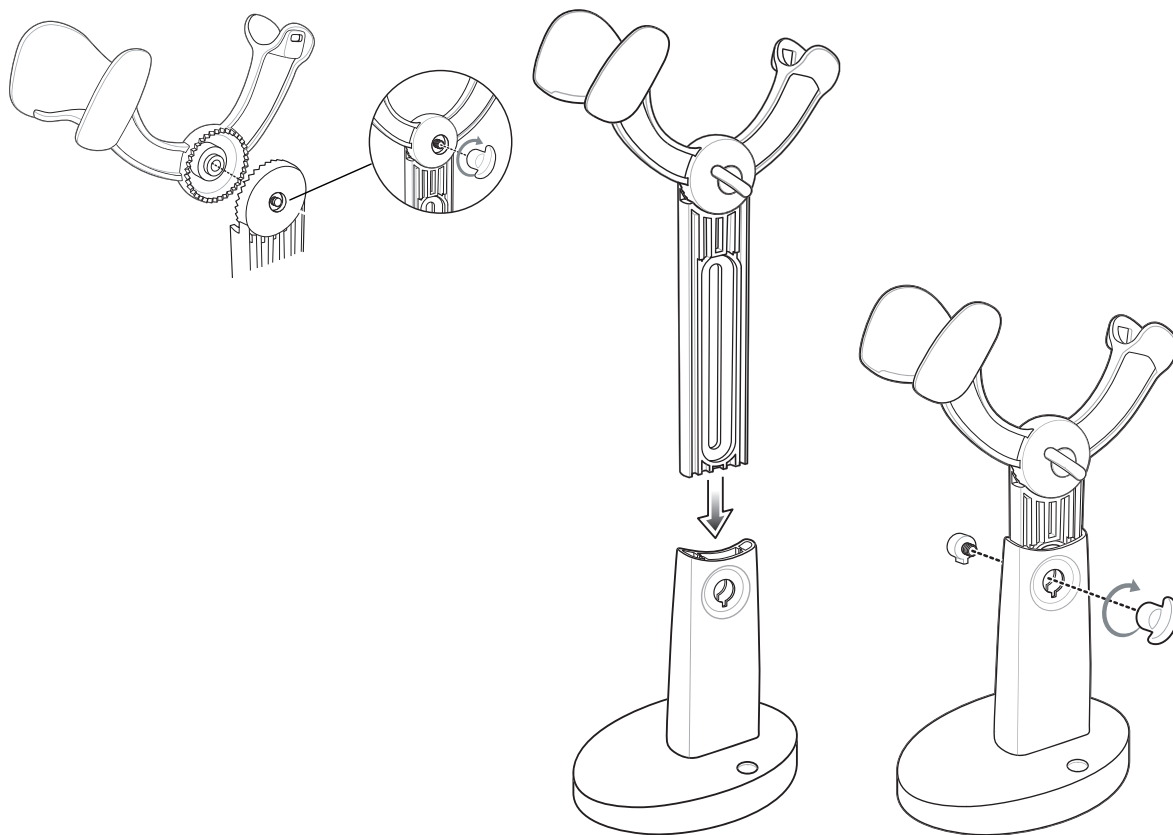

Figure 2-2 Assembling Intellistand

Scanning with Intellistand

When the digital scanner is placed in Intellistand it operates in continuous (constant-on) mode, where it automatically decodes a bar code presented in its field of view.

To operate the scanner in Intellistand:

1. Ensure the scanner is properly connected to the host (see the appropriate host chapter for information on host connections).
2. Insert the scanner in Intellistand by placing the front of the scanner into the stand's "cup."

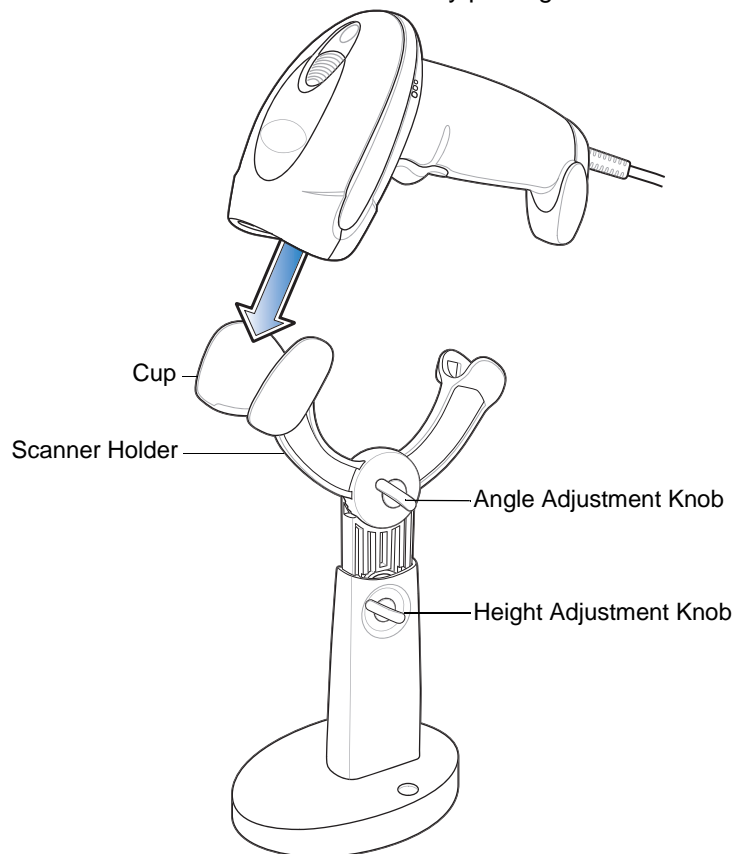

Figure 2-3 *Inserting the Scanner in the Intellistand*

3. Use the Intellistand's adjustment knobs to adjust the height and angle of the scanner.
4. Present the bar code.
5. Upon successful decode, the scanner beeps and the LED turns green. For more information about beeper and LED definitions, see [Table 2-1](#) and [Table 2-2](#).

Scanning in Hand-Held Mode

Pick up the digital scanner. Press and release the trigger. The aim pattern displays.

1. Ensure the bar code is centered in the aiming pattern. See [Aiming](#) below.
2. Press and hold the trigger until either:
 - a. The digital scanner reads the bar code. The digital scanner beeps, the LED flashes, and the aiming pattern turns off.
 - Or
 - b. The digital scanner does not read the bar code and the aiming pattern turns off.
3. Release the trigger. To read another bar code, repeat steps 1, 2 and 3. Repeat this step as often as required.

Aiming

When scanning, the digital scanner projects a red LED dot which allows positioning the bar code within its field of view. See [Decode Ranges on page 2-9](#) for the proper distance to achieve between the digital scanner and a bar code.

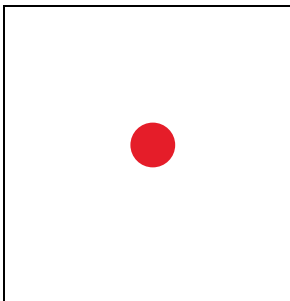

Figure 2-4 Aiming Dot

If necessary, the digital scanner turns on its red illumination LEDs to illuminate the target bar code.

To scan a barcode, center the symbol and ensure the entire symbol is within the rectangular area formed by the illumination LEDs.

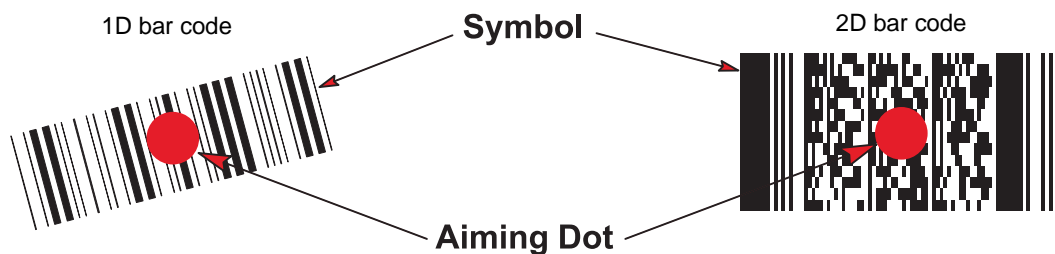

Figure 2-5 Scanning Orientation with Aiming Dot

The digital scanner can also read a bar code presented within the aiming pattern but not centered. The top examples in [Figure 2-6](#) show acceptable aiming options, while the bottom examples can not be decoded.

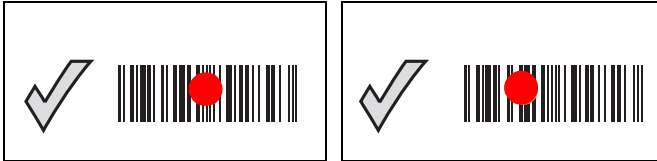

Figure 2-6 *Acceptable Aiming*

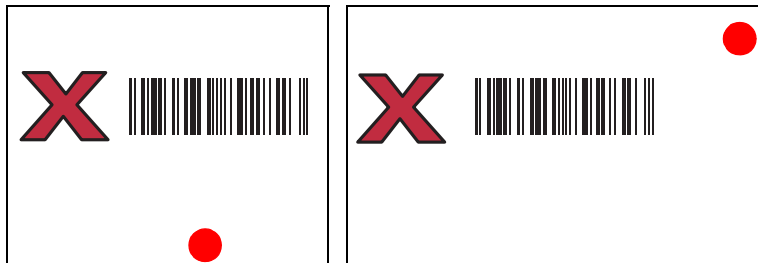

Figure 2-7 *Incorrect Aiming*

The aiming pattern is smaller when the digital scanner is closer to the symbol and larger when it is farther from the symbol. Scan symbols with smaller bars or elements (mil size) closer to the digital scanner, and those with larger bars or elements (mil size) farther from the digital scanner.

The digital scanner beeps to indicate that it successfully decoded the bar code. For more information on beeper and LED definitions, see [Table 2-1](#) and [Table 2-2](#).

Decode Ranges

Table 2-3 *Standard Range (SR) Decode Ranges*

Symbol Density	Bar Code Type	Typical Working Ranges	
		Near	Far
5.0 mil	Code 39	0.2 in / 0.5 cm	6.8 in / 17.3 cm
10 mil	80% UPCA	0 in / 0 cm	12.7 in / 32.3 cm
13 mil	100% UPCA	0.3 in / 0.8 cm	15.2 in / 38.6 cm
5.0 mil	PDF 417	1.5 in / 3.8 cm	4.3 in / 10.9 cm
6.6 mil	PDF 417	0.8 in / 2.0 cm	6.0 in / 15.2 cm
10 mil	Data Matrix	0.4 in / 1.0 cm	7.2 in / 18.3 cm

Chapter 3 Maintenance, Troubleshooting & Technical Specifications

Introduction

This chapter provides suggested digital scanner maintenance, troubleshooting, technical specifications, and signal descriptions (pinouts).

Maintenance

Cleaning the scan window is the only maintenance required. A dirty window can affect scanning accuracy.

- Do not allow abrasive material to touch the window.
- Remove any dirt particles with a damp cloth.
- Wipe the window using a tissue moistened with ammonia/water.
- Do not spray water or other cleaning liquids directly into the window.

Troubleshooting

Table 3-1 *Troubleshooting*

Problem	Possible Causes	Possible Solutions
The aiming pattern does not appear when pressing the trigger.	No power to the digital scanner.	If the configuration requires a power supply, re-connect the power supply.
	Incorrect host interface cable is used.	Connect the correct host interface cable.
	Interface/power cables are loose.	Re-connect cables.
	Digital scanner is disabled.	For IBM 468x and USB IBM hand-held, IBM table top, and OPOS modes, enable the digital scanner via the host interface. Otherwise, see the technical person in charge of scanning.
	If using RS-232 Nixdorf B mode, CTS is not asserted.	Assert CTS line.
	Aiming pattern is disabled.	Enable the aiming pattern. See Hand-Held Decode Aiming Pattern on page 4-19 .
Digital scanner emits aiming pattern, but does not decode the bar code.	Digital scanner is not programmed for the correct bar code type.	Program the digital scanner to read that type of bar code. See Chapter 9, Symbologies .
	Bar code symbol is unreadable.	Scan test symbols of the same bar code type to determine if the bar code is defaced.
	The symbol is not completely inside aiming pattern.	Move the symbol completely within the aiming pattern. Move the symbol completely within the field of view (AIM pattern does NOT define FOV)
	Distance between digital scanner and bar code is incorrect.	Move the scanner closer to or further from the bar code. See Decode Ranges on page 2-9 .

Table 3-1 Troubleshooting (Continued)

Problem	Possible Causes	Possible Solutions
Digital scanner decodes bar code, but does not transmit the data to the host.	Digital scanner is not programmed for the correct host type.	Scan the appropriate host type programming bar code. See the chapter corresponding to the host type.
	Interface cable is loose.	Re-connect the cable.
	If the digital scanner emits 4 long low beeps, a transmission error occurred. This occurs if a unit is not properly configured or connected to the wrong host type.	Set the scanner's communication parameters to match the host's setting.
	If the digital scanner emits 5 low beeps, a conversion or format error occurred.	Configure the digital scanner's conversion parameters properly.
	If the digital scanner emits low/high/low beeps, it detected an invalid ADF rule.	Program the correct ADF rules. Refer to the <i>Advanced Data Formatting Programmer Guide</i> .
	If the digital scanner emits high/low beeps, the scanner is buffering Code 39 data.	Normal scanning a Code 39 bar code and the Code 39 Buffering option is enabled.
Host displays scanned data incorrectly.	Digital scanner is not programmed to work with the host.	Scan the appropriate host type programming bar code.
		For RS-232, set the digital scanner's communication parameters to match the host's settings.
		For a Keyboard Wedge configuration, program the system for the correct keyboard type, and turn off the CAPS LOCK key.
		Program the proper editing options (e.g., UPC-E to UPC-A Conversion).
Digital scanner emits short low/short medium/short high beep sequence (power-up beep sequence) more than once.	The USB bus may put the digital scanner in a state where power to the scanner is cycled on and off more than once.	Normal during host reset.
Digital scanner emits 4 short high beeps during decode attempt.	Digital scanner has not completed USB initialization.	Wait several seconds and scan again.
Digital scanner emits Low/low/low/extra low beeps when not in use.	RS-232 receive error.	Normal during host reset. Otherwise, set the digital scanner's RS-232 parity to match the host setting.
Digital scanner emits low/high beeps during programming.	Input error, incorrect bar code or Cancel bar code was scanned.	Scan the correct numeric bar codes within range for the parameter programmed.

Table 3-1 Troubleshooting (Continued)

Problem	Possible Causes	Possible Solutions
Digital scanner emits low/high/low/high beeps during programming.	Out of host parameter storage space.	Scan Set Default Parameter on page 4-4 .
	Out of memory for ADF rules.	Reduce the number of ADF rules or the number of steps in the ADF rules.
	During programming, indicates out of ADF parameter storage space.	Erase all rules and re-program with shorter rules.
Digital scanner emits low/high/low beeps.	Clearing Code 39 buffer.	Normal when scanning the Code 39 Buffering Clear Buffer bar code or upon attempt to transmit an empty Code 39 buffer.
	ADF transmit error.	Refer to the Advanced Data Formatting Guide for information.
	Invalid ADF rule is detected.	Refer to the Advanced Data Formatting Guide for information.
Digital scanner emits a power-up beep after changing USB host type.	The USB bus re-established power to the digital scanner.	Normal when changing USB host type.
Digital scanner emits one high beep when not in use.	In RS-232 mode, a <BEL> character was received and Beep on <BEL> option is enabled.	Normal when Beep on <BEL> is enabled and the digital scanner is in RS-232 mode.
Digital scanner emits frequent beeps.	No power to the scanner.	Check the system power. If the configuration requires a power supply, re-connect the power supply.
	Incorrect host interface cable is used.	Verify that the correct host interface cable is used. If not, connect the correct host interface cable.
	Interface/power cables are loose.	Check for loose cable connections and re-connect cables.
Digital scanner emits five long low beeps after a bar code is decoded.	Conversion or format error was detected. The scanner's conversion parameters are not properly configured.	Ensure the scanner's conversion parameters are properly configured.
	Conversion or format error was detected. An ADF rule was set up with characters that can't be sent for the host selected.	Change the ADF rule, or change to a host that can support the ADF rule.
	Conversion or format error was detected. A bar code was scanned with characters that can't be sent for that host.	Change the bar code, or change to a host that can support the bar code.



NOTE If after performing these checks the digital scanner still experiences problems, contact the distributor or call Motorola Solutions Support.

Technical Specifications

Table 3-2 *Technical Specifications*

Item	Description
Physical Characteristics	
Dimensions	6.7 in. H x 3.7 in. L x 2.7 in. W (17 cm H x 9.3 cm L x 6.8 cm W)
Weight (without cable)	6.1 oz. (172.9 g)
Power	5 VDC +/- 10% @ 275 mA (RMS typical)
Performance Characteristics	
Light Source	Aiming pattern: 617 nm LED Illumination: 625 nm LEDs
Field of View (Vertical x Horizontal)	39° (H) x 25° (V)
Roll	0 - 360°
Pitch	+/- 65° or greater
Yaw	+/- 60° or greater
Symbology Decode Capability	
1D	UPC/EAN, UPC/EAN with supplementals, Bookland EAN, ISSN, UCC Coupon Extended Code, Code 128, GS1-128, ISBT 128, Code 39, Code 39 Full ASCII, Trioptic Code 39, Code 32, Code 93, Code 11, Matrix 2 of 5, Interleaved 2 of 5, Discrete 2 of 5, Korean 2 of 5, ISBT Concatenation, Codabar, MSI, Chinese 2 of 5, GS1 DataBar variants
2D	PDF417, MicroPDF417, Composite Codes, TLC-39, Data Matrix, Maxicode, QR Code, MicroQR, Aztec
Postal	Australian Post, US PLANET, Royal Mail 4 State Customer, US POSTNET, KIX Code (Dutch), UK Postal, Japan Post, UPU 4 State Postal FICS (Post US4), USPS 4 State Postal (Post US3)
Typical Working Distance	See Decode Ranges on page 2-9 .
Motion Tolerances	Up to 25 inches per second
Interfaces Supported	The scanner supports the following protocols over USB: HID Keyboard (default mode), SNAPI, COM Port Emulation, IBM SurePOS (Yellowstone) (IBM Handheld, IBM Tabletop, OPOS) The scanner supports the following protocols over RS232: Standard, Wincor-Nixdorf, ICL, Fujitsu, Olivetti, Omron, CUTE

Table 3-2 *Technical Specifications (Continued)*

Item	Description
Minimum Resolution	Code 39 4 mil UPC 60% 5 mil PDF417 5 mil Datamatrix 7.5 mil
User Environment	
Operating Temperature	32° F to 104° F (0° C to 40° C)
Storage Temperature	-40° F to 158° F (-40° C to 70° C)
Humidity	5% to 95%, non-condensing
Drop Specifications	Withstands multiple 6 ft. (1.83 m) drops to concrete.
Environmental Sealing	IP43
Ambient Light Immunity	Immune to normal indoor lighting up to 1600 Lux. Immune to sunlight up to 86,000 Lux.
Accessories	
Hands-Free Options	Intellistand
Power Supplies	Power supplies are available for applications that do not supply power over the host cable.

Digital Scanner Signal Descriptions

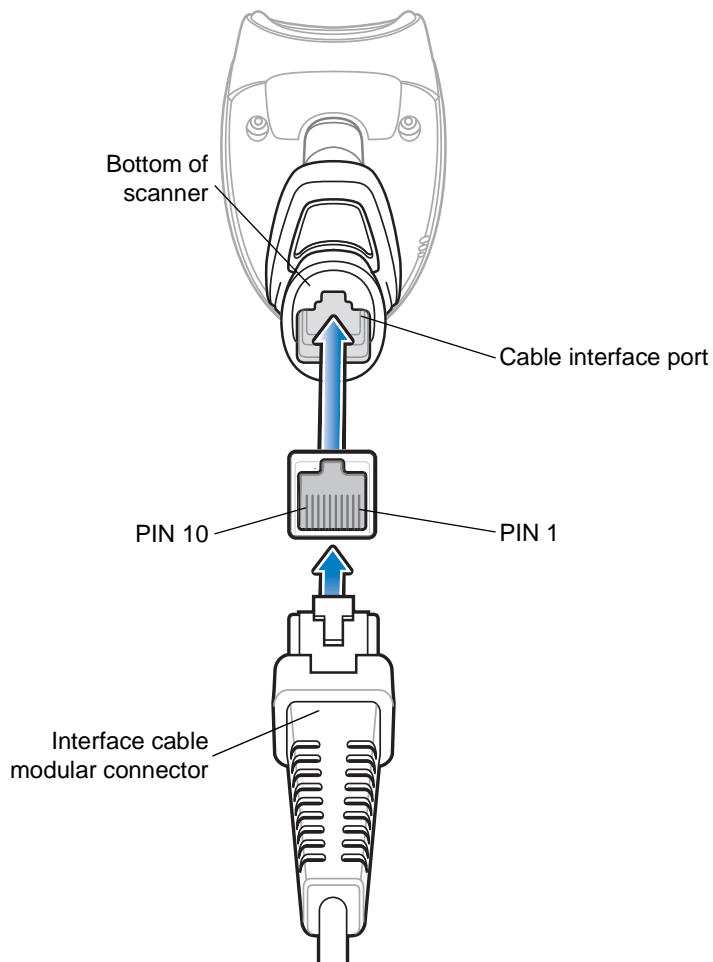

Figure 3-1 Digital Scanner Cable Pinouts

The signal descriptions in [Table 3-3](#) apply to the connectors on the DS4208 digital scanner and are for reference only.

Table 3-3 DS4208 Digital Scanner Signal Pin-outs

Pin	IBM	RS-232	Keyboard Wedge	USB
1	Reserved	Reserved	Reserved	Jump to Pin 6
2	Power	Power	Power	Power
3	Ground	Ground	Ground	Ground
4	IBM_A(+)	TxD	KbdClock	Reserved
5	Reserved	RxD	TermData	D +
6	IBM_B(-)	RTS	KbdData	Jump to Pin 1
7	Reserved	CTS	TermClock	D -

Table 3-3 *DS4208 Digital Scanner Signal Pin-outs (Continued)*

8	Reserved	Reserved	Reserved	Reserved
9	EAS	EAS	EAS	EAS
10	EAS	EAS	EAS	EAS

Chapter 4 User Preferences & Miscellaneous Digital Scanner Options

Introduction

You can program the digital scanner to perform various functions, or activate different features. This chapter describes each user preference feature and provides programming bar codes for selecting these features.

The digital scanner ships with the settings shown in [Table 4-1 on page 4-2](#) (also see [Appendix A, Standard Default Parameters](#) for all host device and miscellaneous defaults). If the default values suit requirements, programming is not necessary.

To set feature values, scan a single bar code or a short bar code sequence. The settings are stored in non-volatile memory and are preserved even when the digital scanner is powered down.

✓ **NOTE** Most computer monitors allow scanning the bar codes directly on the screen (when using the imaging engine). When scanning from the screen, be sure to set the document magnification to a level where you can see the bar code clearly, and bars and/or spaces are not merging.

If not using a USB cable, select a host type (see each host chapter for specific host information) after the power-up beeps sound. This is only necessary upon the first power-up when connected to a new host.

To return all features to default values, scan the [Set Default Parameter on page 4-4](#). Throughout the programming bar code menus, asterisks indicate (*) default values.



* Indicates Default — *High Volume — Feature/Option
(00h) — Option Hex Value

Scanning Sequence Examples

In most cases, scanning one bar code sets the parameter value. For example, to set the beeper tone to high, scan the **High Frequency** (beeper tone) bar code listed under [Beeper Tone on page 4-6](#). The digital scanner issues a fast warble beep and the LED turns green, signifying a successful parameter entry.

Other parameters, such as **Serial Response Time-Out** or **Data Transmission Formats**, require scanning several bar codes. See these parameter descriptions for this procedure.

Errors While Scanning

Unless otherwise specified, to correct an error during a scanning sequence, just re-scan the correct parameter.

Parameter Defaults

[Table 4-1](#) lists defaults for user preferences parameters. To change the default values, scan the appropriate bar codes in this guide. These new values replace the standard default values in memory. To recall the default parameter values, scan the [Set Default Parameter on page 4-4](#).

✓ **NOTE** See [Appendix A, Standard Default Parameters](#) for all user preferences, hosts, symbologies, and miscellaneous default parameters.

Table 4-1 User Preferences Parameter Defaults

Parameter	Parameter Number	Default	Page Number
User Preferences			
Set Default Parameter		Set Defaults	4-4
Parameter Bar Code Scanning	ECh	Enable	4-5
Beep After Good Decode	38h	Enable	4-5
Beeper Tone	91h	Medium	4-6
Beeper Volume	8Ch	High	4-7
Beeper Duration	F1h 74h	Medium	4-7
Suppress Power-up Beeps	F1h D1h	Do not suppress	4-8
Low Power Mode	80h	Disable	4-8
Time Delay to Low Power Mode	92h	1 Hour	4-9
Hand-Held Trigger Mode	8Ah	Auto Aim	4-11
Picklist Mode	F0h 92h	Always Disabled	4-12
Continuous Bar Code Read	F1h 89h	Disable	4-13
Unique Bar Code Reporting	F1h D31h	Disable	4-13

Table 4-1 *User Preferences Parameter Defaults (Continued)*

Parameter	Parameter Number	Default	Page Number
Decode Session Timeout	88h	9.9 Sec	4-14
Timeout Between Decodes, Same Symbol	89h	0.5 Sec	4-14
Timeout Between Decodes, Different Symbols	90h	0.2 Sec	4-15
Fuzzy 1D Processing	F1h 02h	Enable	4-15
Decode Mirror Images (Data Matrix Only)	F1h 19h	Auto	4-16
Mobile Phone/Display Mode	F1h CCh	Enable in Both Hand-Held and Hands-Free Modes	4-17
PDF Prioritization	F1h CFh	Disable	4-18
PDF Prioritization Timeout	F1h D0h	200 ms	4-18
Hand-Held Decode Aiming Pattern	F0h 32h	Enable	4-19
Hands-Free Decode Aiming Pattern	F1h 4Eh	Enable Hands-Free Decode Aiming Pattern on PDF	4-20
Presentation Mode Field of View	F1h 61h	Full	4-21
Decoding Illumination	F0h 2Ah	Enable	4-22
Multicode Mode	F1h A5h	Disable	4-22
Multicode Expression	F1h 95h	1	4-23
Multicode Mode Concatenation	F1h CDh	Disable	4-28
Multicode Concatenation Symbology	F1h D2h	Concatenate as PDF417	4-29
Miscellaneous Options			
Transmit Code ID Character	2Dh	None	4-32
Prefix Value	63h 69h	7013 <CR><LF>	4-33
Suffix 1 Value	62h 68h	7013 <CR><LF>	4-33
Suffix 2 Value	64h 6Ah		
Scan Data Transmission Format	EBh	Data as is	4-34
FN1 Substitution Values	67h 6Dh	7013 <CR> <LF>	4-35
Transmit "No Read" Message	5Eh	Disable	4-36

User Preferences

Set Default Parameter

You can reset the digital scanner to two types of defaults: factory defaults or custom defaults. Scan the appropriate bar code below to reset the digital scanner to its default settings and/or set its current settings as custom defaults.

- **Set Defaults** - Scan this bar code to reset all default parameters as follows.
 - If you previously set custom defaults by scanning **Write to Custom Defaults**, scan **Set Defaults** to retrieve and restore the digital scanner's custom default settings.
 - If you did not set custom defaults, scan **Restore Defaults** to restore the factory default values listed in [Table A-1](#).
- **Set Factory Defaults** - Scan this bar code to restore the factory default values listed in [Table A-1](#). This deletes any custom defaults set.
- **Write to Custom Defaults** - Scan this bar code to set the current digital scanner settings as custom defaults. Once set, you can recover custom default settings by scanning **Restore Defaults**.



* **Set Defaults**



Set Factory Defaults



Write to Custom Defaults

Parameter Bar Code Scanning

Parameter # ECh

To disable the decoding of parameter bar codes, including the **Set Defaults** parameter bar codes, scan the **Disable Parameter Scanning** bar code below. To enable decoding of parameter bar codes, scan **Enable Parameter Scanning**.



* Enable Parameter Bar Code Scanning
(01h)



Disable Parameter Bar Code Scanning
(00h)

Beeper Preferences

Beep After Good Decode

Parameter # 38h

Scan a bar code below to select whether or not the digital scanner beeps after a good decode. If selecting **Do Not Beep After Good Decode**, the beeper still operates during parameter menu scanning and to indicate error conditions.



* Beep After Good Decode
(Enable)
(01h)

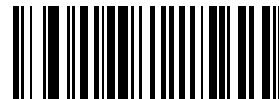

Do Not Beep After Good Decode
(Disable)
(00h)

Beeper Tone

Parameter # 91h

To select a decode beep frequency (tone), scan one of the following bar codes.

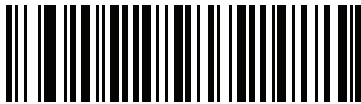

Off
(03h)

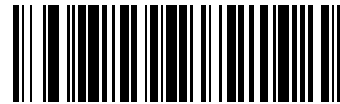

Low Tone
(02h)

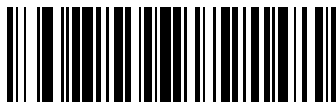

* Medium Tone
(01h)



High Tone
(00h)



Medium to High Tone (2-tone)
(04h)

Beeper Volume

Parameter # 8Ch

To select a beeper volume, scan the **Low Volume**, **Medium Volume**, or **High Volume** bar code.



Low Volume
(02h)



Medium Volume
(01h)



* High Volume
(00h)

Beeper Duration

Parameter # F1h 74h

To select the duration for the beeper, scan one of the following bar codes.



Short
(00h)



* Medium
(01h)



Long
(02h)

Suppress Power-up Beeps

Parameter # F1h D1h

Select whether or not to suppress the digital scanner's power-up beeps.



* Do Not Suppress Power-up Beeps
(00h)

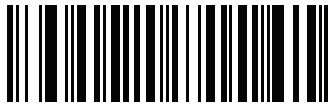

Suppress Power-up Beeps
(01h)

Low Power Mode

Parameter # 80h

This parameter determines whether or not the digital scanner enters low power mode after a decode attempt. If disabled, power remains on after each decode attempt.



* Disable Low Power Mode
(00h)



Enable Low Power Mode
(01h)

Time Delay to Low Power Mode**Parameter # 92h**

✓ **NOTE** This parameter only applies when Low Power Mode is enabled.

This parameter sets the time the digital scanner remains active before entering low power mode. The digital scanner wakes upon trigger pull or when the host attempts to communicate with the digital scanner.



1 Second
(11h)



10 Seconds
(1Ah)



1 Minute
(21h)



5 Minutes
(25h)



15 Minutes
(2Bh)

Time Delay to Low Power Mode (continued)

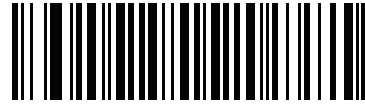

**30 Minutes
(2Dh)**

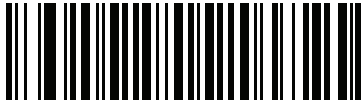

**45 Minutes
(2Eh)**



*** 1 Hour
(31h)**

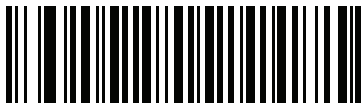

**3 Hours
(33h)**

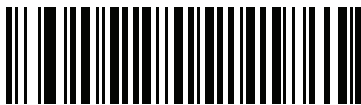

**6 Hours
(36h)**



**9 Hours
(39h)**

Hand-Held Trigger Mode

Parameter # 8Ah

Select one of the following trigger modes for the digital scanner:

- **Standard (Level)** - A trigger pull activates decode processing. Decode processing continues until the bar code decodes, you release the trigger, or the Decode Session Timeout occurs.
- **Presentation (Blink)** - The digital scanner activates decode processing when it detects a bar code in its field of view. After a period of non-use, the digital scanner enters a low power mode, in which the LEDs turn off until the digital scanner senses motion.
- **Auto Aim** - This trigger mode turns on the LED aiming dot when the scanner is lifted. A trigger pull activates decode processing. After 2 seconds of inactivity the aiming pattern shuts off.



Standard (Level)
(00h)



Presentation (Blink)
(07h)



*** Auto Aim**
(09h)

Picklist Mode

Parameter # F0h 92h

Picklist mode enables the digital scanner to decode only bar codes that are aligned under the LED aiming dot. Select one of the following picklist modes for the digital scanner:

- **Always Disable** - Picklist mode is always disabled.
- **Enabled in Hand-Held Mode** - Picklist mode is enabled when the digital scanner is out of hands-free mode and disabled when the digital scanner is in presentation mode.
- **Always Enable** - Picklist mode is always enabled.



* Always Disable
(00h)



Enabled in Hand-Held Mode
(01h)



Always Enable
(02h)

Continuous Bar Code Read

Parameter # F1h 89h

Enable this to report every bar code while the trigger is pressed.



NOTE Motorola strongly recommends enabling [Picklist Mode on page 4-12](#) with this feature. Disabling Picklist Mode can cause accidental decodes when more than one bar code is in the engine's field of view.



* Disable Continuous Bar Code Read
(00h)



Enable Continuous Bar Code Read
(01h)

Unique Bar Code Reporting

Parameter # F1h D3h

Enable this to report only unique bar codes while the trigger is pressed. This option only applies when **Continuous Bar Code Read** is enabled.



* Disable Continuous Bar Code Read Uniqueness
(00h)



Enable Continuous Bar Code Read Uniqueness
(01h)

Decode Session Timeout

Parameter # 88h

This parameter sets the maximum time decode processing continues during a scan attempt. It is programmable in 0.1 second increments from 0.5 to 9.9 seconds. The default timeout is 9.9 seconds.

To set a Decode Session Timeout, scan the bar code below. Next, scan two numeric bar codes from [Appendix D, Numeric Bar Codes](#) that correspond to the desired on time. Enter a leading zero for single digit numbers. For example, to set a Decode Session Timeout of 0.5 seconds, scan the bar code below, then scan the **0** and **5** bar codes. To correct an error or change the selection, scan **Cancel** on [page D-2](#).

- ✓ **NOTE** Decode Session Timeout cannot be less than or equal to either Timeout Between Decodes, Same Symbol or Timeout Between Decodes, Different Symbols.



Decode Session Timeout

Timeout Between Decodes, Same Symbol

Parameter # 89h

Use this option in presentation mode or Continuous Bar Code Read to prevent the beeper from continuously beeping when a symbol is left in the digital scanner's field of view. It is programmable in 0.1 second increments from 0.0 to 9.9 seconds. The default interval is 0.5 seconds.

To select the timeout between decodes for the same symbol, scan the bar code below, then scan two numeric bar codes from [Appendix D, Numeric Bar Codes](#) that correspond to the desired interval, in 0.1 second increments.

- ✓ **NOTE** Timeout Between Decodes, Same Symbol cannot be greater than or equal to the Decode Session Timeout.



Timeout Between Decodes, Same Symbol

Timeout Between Decodes, Different Symbols

Parameter # 90h

Use this option in presentation mode or Continuous Bar Code Read to control the time the scanner is inactive between decoding different symbols. It is programmable in 0.1 second increments from 0.1 to 9.9 seconds. The default is 0.2 seconds.

To select the timeout between decodes for different symbols, scan the bar code below, then scan two numeric bar codes from [Appendix D, Numeric Bar Codes](#) that correspond to the desired interval, in 0.1 second increments.

✓ **NOTE** Timeout Between Decodes, Different Symbols cannot be greater than or equal to the Decode Session Timeout.



Timeout Between Decodes, Different Symbols

Fuzzy 1D Processing

Parameter # F1h 02h

This option is enabled by default to optimize decode performance on 1D bar codes, including damaged and poor quality symbols. Disable this only if you experience time delays when decoding 2D bar codes, or in detecting a no decode.



* Enable Fuzzy 1D Processing
(01h)



Disable Fuzzy 1D Processing
(00h)

Decode Mirror Images (Data Matrix Only)

Parameter # F1h 19h

Select an option for decoding mirror image Data Matrix bar codes:

- Always - decode only Data Matrix bar codes that are mirror images
- Never - do not decode Data Matrix bar codes that are mirror images
- Auto - decode both mirrored and unmirrored Data Matrix bar codes.



Never
(00h)



Always
(01h)



*** Auto**
(02h)

Mobile Phone/Display Mode

Parameter # F1h CCh

This mode improves bar code reading performance off mobile phones and electronic displays. Enable this in hand-held, hands-free, or both modes, or disable this.

✓ **NOTE** If you enable this mode, for best performance also enable [Hands-Free Decode Aiming Pattern on page 4-20](#).



Disable Mobile Phone/Display Mode
(00h)

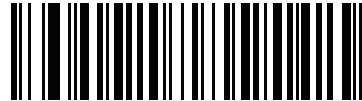

Enable in Hand-Held Mode
(01h)



Enable in Hands-Free Mode
(02h)

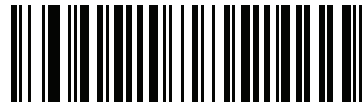

* Enable in Both Modes
(03h)

PDF Prioritization

Parameter # F1h CFh

Enable this feature to delay decoding a 1D bar code (Code 128 of 8 to 25 characters length) by the value specified in [PDF Prioritization Timeout](#). During that time the digital scanner attempts to decode a PDF417 symbol (e.g., on a US driver's license), and if successful reports this only. If it does not decode (can not find) a PDF417 symbol, it reports the 1D symbol after the timeout. The 1D symbol must be in the device's field of view for the digital scanner to report it. This parameter does not affect decoding other symbologies.



* Disable PDF Prioritization
(00h)



Enable PDF Prioritization
(01h)

PDF Prioritization Timeout

Parameter # F1h D0h

When [PDF Prioritization](#) is enabled, this timeout specifies how long the digital scanner attempts to decode a PDF417 symbol before reporting the 1D bar code in the field of view.

Scan the following bar code, then scan four digits from [Appendix D, Numeric Bar Codes](#) that specify the timeout in milliseconds. For example, to enter 400 ms, scan the following bar code, then scan 0400. The range is 0 to 5000 ms, and the default is 200 ms.



PDF Prioritization Timeout

Hand-Held Decode Aiming Pattern

Parameter # F0h 32h

Select **Enable Hand-Held Decode Aiming Pattern** to project the aiming pattern during bar code capture, **Disable Hand-Held Decode Aiming Pattern** to turn the aiming pattern off, or **Enable Hand-Held Decode Aiming Pattern on PDF** to project the aiming pattern when the digital scanner detects a 2D bar code.

✓ **NOTE** With [Picklist Mode on page 4-12](#) enabled, the decode aiming pattern flashes even when the **Decode Aiming Pattern** is disabled.

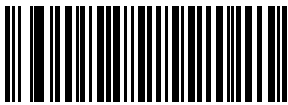

* Enable Hand-Held Decode Aiming Pattern
(02h)



Disable Hand-Held Decode Aiming Pattern
(00h)

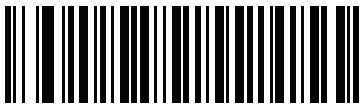

Enable Hand-Held Decode Aiming Pattern on PDF
(03h)

Hands-Free Decode Aiming Pattern

Parameter # F1h 4Eh

Select **Enable Hands-Free Decode Aiming Pattern** to project the aiming pattern during bar code capture, **Disable Hands-Free Decode Aiming Pattern** to turn the aiming pattern off, or **Enable Hands-Free Decode Aiming Pattern on PDF** to project the aiming pattern when the digital scanner detects a PDF bar code.

✓ **NOTE** With [Picklist Mode on page 4-12](#) enabled, the decode aiming pattern flashes even when the **Decode Aiming Pattern** is disabled.



Enable Hands-Free Decode Aiming Pattern
(01h)



Disable Hands-Free Decode Aiming Pattern
(00h)



* Enable Hands-Free Decode Aiming Pattern on PDF
(02h)

Presentation Mode Field of View

Parameter # F1h 61h

In presentation mode, by default the digital scanner searches the larger area of the aiming pattern (**Full Field of View**).

To search for a bar code in a smaller region around the aiming pattern in order to speed search time, select **Small Field of View** or **Medium Field of View**.



**Small Field of View
(00h)**



**Medium Field of View
(01h)**

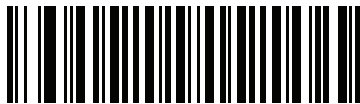

*** Full Field of View
(02h)**

Decoding Illumination (Hand-held Mode only)

Parameter # F0h 2Ah

Selecting **Enable Decoding Illumination** causes the digital scanner to flash illumination to aid decoding. Select **Disable Decoding Illumination** to prevent the digital scanner from using decoding illumination.

Enabling illumination usually results in superior decoding. The effectiveness of the illumination decreases as the distance to the target increases.



* Enable Decoding Illumination
(01h)



Disable Decoding Illumination
(00h)

Multicode Mode

Parameter # F1h A5h

Enable this parameter to allow multiple bar codes to decode upon one trigger event based on the programmed multicode expression. The digital scanner reports a successful decode and provides user indication only if it decodes all bar codes indicated by the multicode expression, otherwise the decode fails. Bar codes are transmitted in the order defined in the multicode expression. Disable this to operate in normal decode mode.

✓ **NOTES** Enabling **Multicode Mode** disables *Picklist Mode*.

Multicode does not operate in presentation mode.

Do not use **Multicode Mode** if *Continuous Bar Code Read* is enabled.

When using this mode, always orient the digital scanner at the same distance and angle (perpendicular).

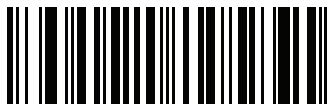

* Disable Multicode Mode
(00h)



Enable Multicode Mode
(01h)

Multicode Expression

Parameter # F1h 95h

Use this feature to program a multicode expression for *Multicode Mode* (grid method). The default is 1, which indicates any bar code.

To set the multicode expression:

1. Scan the bar code below.
2. Scan bar codes from the alphanumeric keyboard in the *Advanced Data Formatting Programmer Guide* to define the expression.
3. Scan the **End of Message** bar code from the *Advanced Data Formatting Programmer Guide*.



Multicode Expression

Multicode Expression Syntax: [n] [Element 1]; [Element 2]; ... [Element n];

Where n is the number of elements in the overall expression.

The multicode expression describes the bar code(s) that the digital scanner can expect to find in an image. Each element represents one bar code in the digital scanner's field of view. The order of elements in the expression is the order in which bar code data from each element transmits to the host. Elements are defined using one or more of the following methods:

By Region. This type of element limits decoding to a specific area within the digital scanner's field of view. Region coordinates are defined as the top left and bottom right corners of the region, expressed in percentages of the field of view. These can range from 0% to 100%, or 0x00 to 0x64 in hex, for both horizontal and vertical axes. A region element is constructed as:

[R] [4] [Top, Left] [Bottom, Right]

Where:

- [R] is the character R
- [4] is 0x04, indicating there are four bytes thereafter to describe the region
- [Top, Left] are two values representing the top left corner of the region
- [Bottom, Right] are two values representing the bottom right corner of the region

By Code Type. An element can specify a specific bar code symbology to find and decode somewhere in the field of view. A code type element is constructed as:

[C] [2] [Code Type]

Where:

- [C] is the character C
- [2] is 0x02, indicating there are two bytes thereafter to describe the code type
- [Code Type] is the desired symbology's parameter number (see [Chapter 9, Symbologies](#)). For single-byte parameter numbers, extend the value to two bytes by adding 00 before the parameter number.

Notes

When defining multicode expressions consider the following:

- Use the Code Type specifier if there are bar codes of more than one code type in view.
- Always use the Region specifier when there are multiple bar codes of the same code type.
- When transmission order is important (the first element in the expression transmits first), use either type to define the order.
- When there are unwanted bar codes in view, filter them out in one of two ways:
 - Use Code Type to specify only the target bar codes.
 - Use Region to identify only the target bar codes.
- If the expression does not contain a Region specifier, scanning angle and distance do not matter. If you specify a region you must scan in a fixed orientation and at a fixed distance. Because of this, it is preferable to use the Code Type specifier rather than the Region specifier.
- When defining regions:
 - Defining a region much larger than the bar code improves tolerance to scan distance and angle, but can cause a decode of a nearby bar code instead of the target bar code. Therefore, for best performance define larger regions when only a few bar codes are in view and those in view are widely separated.
 - Defining a region close to (or smaller than) the target bar code improves the probability of decoding this bar code rather than one nearby, but scan distance and angle must be more accurate. Therefore, for best performance define small regions when many bar codes are in view or those in view are close together.
- Use Region elements to improve decode speeds by reducing the image area to search for the target bar code.
- Specifying Code Type may also improve decode speeds for some code types.
- Although you can scan parameter bar codes when multicode mode is enabled, be aware of the following: If the multicode expression defined a region(s), to scan a parameter bar code you must position the bar code within the first region defined in the expression. In some cases, this first region is not the center of the image and aiming at the parameter bar code does not result in a successful decode.

The following examples show the multicode expressions in both hex and decimal formats, however in the sample figures the values are decimal. Be sure to use the correct base numbering system when creating an expression. A region specified as 0x00 0x00 0x64 0x32 represents a region with coordinates of Top-Left (0,0) and Bottom Right (100,50).

Example 1

To decode one Code 128 bar code anywhere in the image (even when bar codes of other types are in view), as in [Figure 4-1](#), program the expression as follows:

The expression in decimal is (formatted for readability):

```
1 C 2 0 8 ;
```

To program the expression via scanning parameters the sequence is (spaces are for readability):

```
[MultiCode-Expression] 01 C 02 00 08 ; [End Of Message]
```

To program the expression via host command (SSI/SNAPI) the sequence is:

```
0x01 0x43 0x02 0x00 0x08 0x3b
```

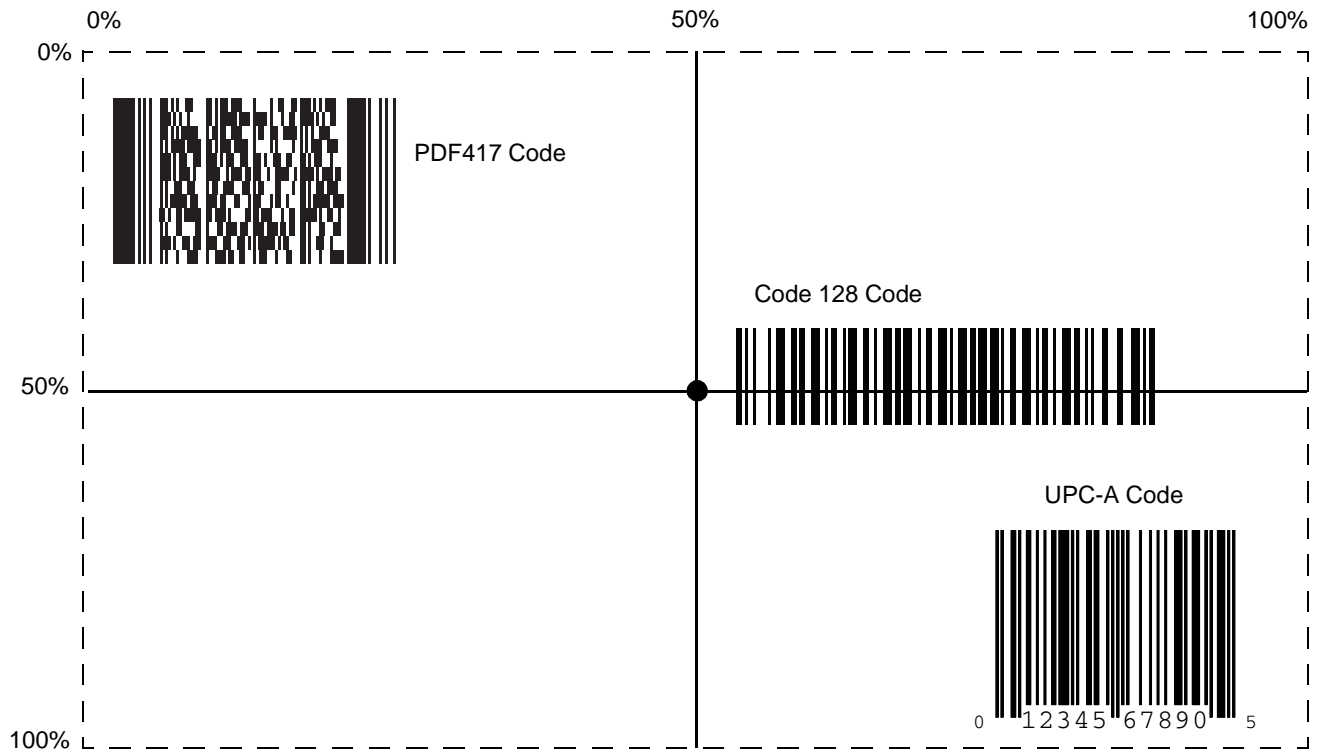

Figure 4-1 Multicode Expression Example 1

Example 2a

To decode a Code128 (Code Type=8) on the top half of the image and a PDF417 (Code Type=15) on the bottom half of the image, as in [Figure 4-2](#), program the expression as follows:

The expression in decimal is (formatted for readability):

```
2 C 2 0 8 R 4 0 0 100 50 ; C 2 0 15 R 4 0 50 100 100 ;
```

To program the expression via scanning parameters the sequence is:

```
[MultiCode-Expression] 02 C 02 00 08 R 04 00 00 64 32 ; C 02 00 0F R 04 00 32 64 64 ; [End Of Message]
```

To program the expression via host command (SSI/SNAPI) the sequence is:

```
0x02 0x43 0x02 0x00 0x08 0x52 0x04 0x00 0x00 0x64 0x32 0x3B 0x43 0x02 0x00 0x0F 0x52 0x04 0x00 0x32 0x64 0x64 0x3B
```

Example 2b

In [Figure 4-2](#), if the bottom PDF417 bar code must transmit first, reverse the sequence of the two bar codes:

The expression in decimal is (formatted for readability):

```
2 C 2 0 15 R 4 0 50 100 100 ; C 2 0 8 R 4 0 0 100 50 ;
```

To program the expression via scanning parameters the sequence is:

```
[MultiCode-Expression] 02 C 02 00 0F R 04 00 32 64 64 ; C 02 00 08 R 04 00 00 64 32 ; [End Of Message]
```

To program the expression via host command (SSI/SNAPI) the sequence is:

```
0x02 0x43 0x02 0x00 0x0F 0x52 0x04 0x00 0x32 0x64 0x64 0x3B 0x43 0x02 0x00 0x08 0x52 0x04 0x00 0x00 0x64 0x32 0x3B
```



Figure 4-2 Multicode Expression Example 2

Example 3

To decode the set of three bar codes while excluding the center Code 128 bar code, as in *Figure 4-3*, the expression is:

The expression in decimal is (formatted for readability):

3 C 2 0 15 R 4 0 0 40 40 ; C 2 [F0 24] R 4 70 0 100 40 ; C 2 0 8 R 4 65 60 100 100 ;

To program the expression via scanning parameters the sequence is:

[MultiCode-Expression] 03 C 02 00 0F R 04 00 00 32 32 ; C 02 F0 24 R 04 46 00 64 28 ;
C 02 00 08 R 04 41 3C 64 64 ; [End Of Message]

To program the expression via host command (SSI/SNAPI) the sequence is:

0x03 0x43 0x02 0x00 0x0F 0x52 0x04 0x00 0x00 0x32 0x32 0x3B 0x43 0x02 0xF0 0x24 0x52 0x04 0x46 0x00
0x64 0x28 0x3B 0x43 0x02 0x00 0x08 0x52 0x04 0x41 0x3C 0x64 0x64 0x3B

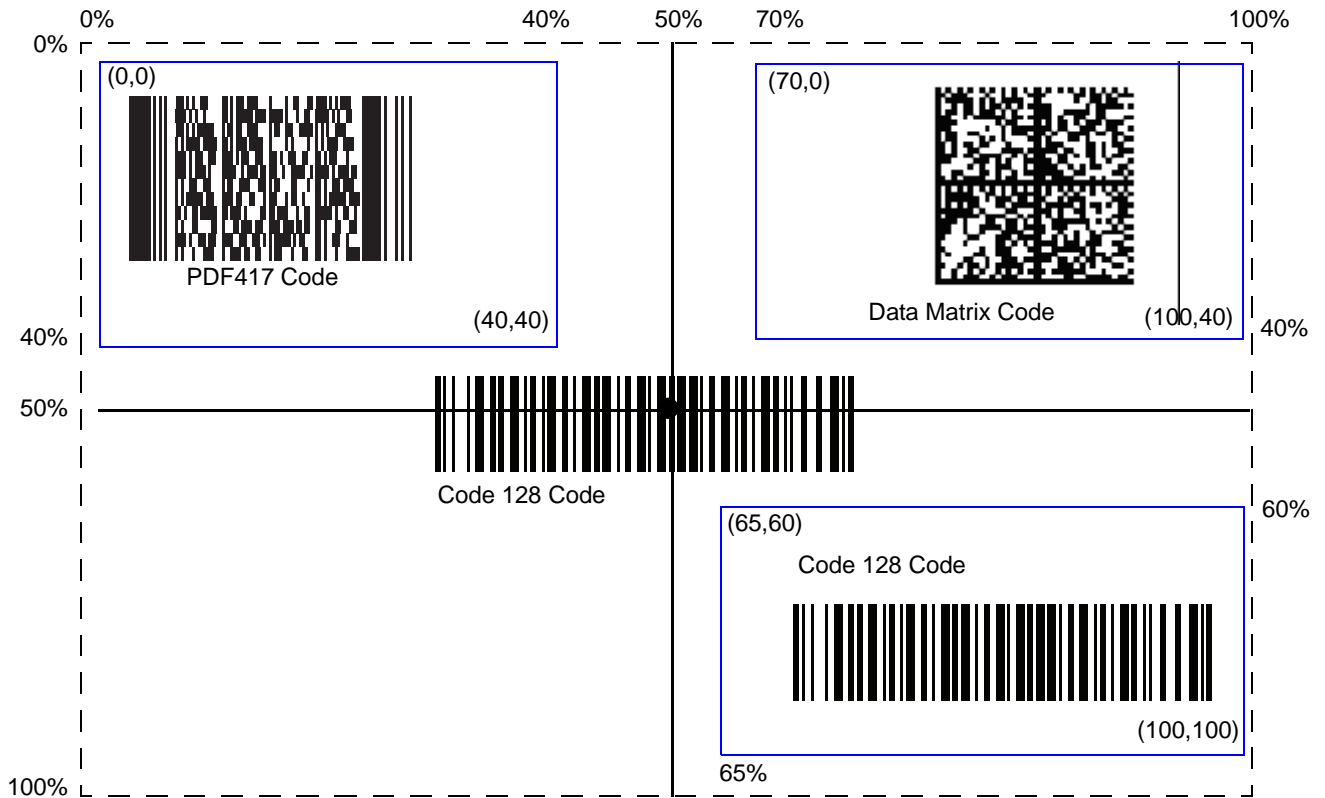

Figure 4-3 Multicode Expression Example 3

Multicode Mode Concatenation

Parameter # F1h CDh

Enable this parameter to transmit multiple decoded bar codes, as specified by the [Multicode Expression](#), as one bar code. Use the [Multicode Concatenation Symbology](#) parameter to specify how the concatenated bar codes transmit.

Disable this to transmit decoded bar codes separately.

✓ **NOTE** When using Multicode Mode Concatenation, disable [Transmit Code ID Character on page 4-32](#) and check digits.



**Enable Multicode Mode Concatenation
(01h)**

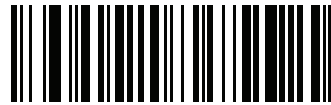

*** Disable Multicode Mode Concatenation
(00h)**

Multicode Concatenation Symbology

Parameter # F1h D2h

Use this parameter to specify how to transmit the concatenated bar codes decoded as specified by the *Multicode Expression*. *Multicode Mode Concatenation* must be enabled to use this option.



Concatenation as Code 128
(01h)

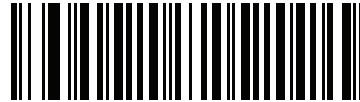

* Concatenation as PDF417
(02h)



Concatenation as Data Matrix
(03h)



Concatenation as Maxicode
(04h)

Multicode Troubleshooting

Troubleshooting Multicode Expression Programming

Use the following suggestions if encountering problems programming a multicode expression:

- Ensure the expression is valid. Invalid expressions are rejected during programming. When an expression is rejected the previous expression remains intact. If after programming the expression the digital scanner can still decode any bar code, the expression was possibly rejected.
- When programming the multicode expression via parameter bar code, the digital scanner generates beeps. If any of the following beeps do not sound during programming, an error occurred (see [Table 2-1 on page 2-2](#) and [Table 2-2 on page 2-4](#) for error indicators):
 - Scanning the **Multicode Expression** bar code produces a two-tone (same pitch) beep.
 - Scanning each value of the expression produces a two-tone (same pitch) beep.
 - Scanning the **End Of Message** bar code produces a four-tone (high-low-high-low) beep.
- Check the expression for syntax errors.
- Try programming a simple expression to ensure the syntax is correct. See [Examples of Simple Multicode Expressions](#).
- Review [Notes on page 4-24](#) for additional hints.

Troubleshooting Multicode Mode Scanning and Decoding

Use the following suggestions if encountering problems using multicode mode:

- If the digital scanner appears to decode any single bar code instead of the intended multiple bar codes, ensure you enabled [Multicode Mode on page 4-22](#). Programming the multicode expression does not enable multicode mode.
- When specifying **Region**, ensure:
 - Coordinates are within range the 0-100 decimal (or 0x00 - 0x64 hexadecimal).
 - Top, Left is above Bottom, Right. Top, Left is 0,0 (0x00, 0x00 hexadecimal), and Bottom, Right is 100,100 (0x64, 0x64 hexadecimal).
 - Regions for two or more bar codes do not overlap.
- When specifying **Code Type** ensure the digital scanner supports the code type. Try decoding a single bar code without using multicode. If it does not decode try enabling the bar code type. See [Chapter 9, Symbologies](#).
- Experiment with simpler expressions, then add to it until you discover the source of the error. For example try the simplest expression (see [Examples of Simple Multicode Expressions](#)) and make sure you can scan a single bar code. If so, extend the expression by adding a second bar code, specifying a region, or specifying the code type. Verify that the digital scanner can decode this new expression. Continue adding to the expression until it fails to decode as expected, indicating the source of the error.
- Review [Notes on page 4-24](#) for additional hints.

Examples of Simple Multicode Expressions

The simplest multicode expression is:

- One bar code of any type, anywhere in the image.
- To program this use: **[MultiCode-Expression] 01 ; [End Of Message]**

Another simple multicode expression is:

- One Code 128 bar code, anywhere in the image.
- To program this use: **[MultiCode-Expression] 01 C 02 00 08 ; [End Of Message]**

Miscellaneous Scanner Parameters

Transmit Code ID Character

Parameter # 2Dh

A Code ID character identifies the code type of a scanned bar code. This is useful when decoding more than one code type. In addition to any single character prefix already selected, the Code ID character is inserted between the prefix and the decoded symbol.

Select no Code ID character, a Symbol Code ID character, or an AIM Code ID character. For Code ID Characters, see [Symbol Code Identifiers on page B-1](#) and [AIM Code Identifiers on page B-3](#).

- ✓ **NOTE** If you enable Symbol Code ID Character or AIM Code ID Character, and enable [Transmit "No Read" Message on page 4-36](#), the digital scanner appends the code ID for Code 39 to the NR message.



Symbol Code ID Character
(02h)



AIM Code ID Character
(01h)



* None
(00h)

Prefix/Suffix Values

Key Category Parameter # P = 63h S1 = 62h S2 = 64h

Decimal Value Parameter # P = 69h S1 = 68h S2 = 6Ah

Default Value = 7013 <CR> <LF>

You can append a prefix and/or one or two suffixes to scan data for use in data editing. To set a value for a prefix or suffix, scan a four-digit number (i.e., four bar codes from [Appendix D, Numeric Bar Codes](#)) that corresponds to that value. See [Table E-1 on page E-1](#) for the four-digit codes.

When using host commands to set the prefix or suffix, set the key category parameter to 1, then set the 3-digit decimal value. See [Table E-1 on page E-1](#) for the four-digit codes.

To correct an error or change a selection, scan [Cancel on page D-2](#).

✓ **NOTE** To use Prefix/Suffix values, first set the [Scan Data Transmission Format on page 4-34](#).

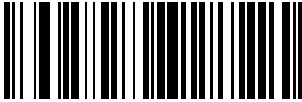

**Scan Prefix
(07h)**

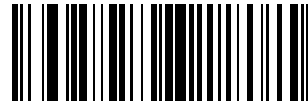

**Scan Suffix 1
(06h)**



**Scan Suffix 2
(08h)**



Data Format Cancel

Scan Data Transmission Format

Parameter # EBh

To change the scan data format, scan one of the following eight bar codes corresponding to the desired format.

✓ **NOTE** If using this parameter do not use ADF rules to set the prefix/suffix.

To set values for the prefix and/or suffix, see [Prefix/Suffix Values on page 4-33](#).



* Data As Is
(00h)



<DATA> <SUFFIX 1>
(01h)



<DATA> <SUFFIX 2>
(02h)



<DATA> <SUFFIX 1> <SUFFIX 2>
(03h)



<PREFIX> <DATA >
(04h)

Scan Data Transmission Format (continued)



FN1 Substitution Values

Key Category Parameter # 67h

Decimal Value Parameter # 6Dh

The wedge and USB HID keyboard hosts support a FN1 Substitution feature. Enabling this substitutes any FN1 character (0x1b) in an EAN128 bar code with a value. This value defaults to 7013 (Enter key).

When using host commands to set the FN1 substitution value, set the key category parameter to 1, then set the 3-digit keystroke value. See the ASCII character set table for the current host interface for the desired value.

To select a FN1 substitution value via bar code menus:

1. Scan the bar code below.

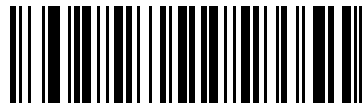

Set FN1 Substitution Value

2. Locate the keystroke desired for FN1 substitution in the ASCII character set table in the appropriate host interface chapter. Enter the 4-digit ASCII value by scanning each digit in [Appendix D, Numeric Bar Codes](#).

To correct an error or change the selection, scan [Cancel on page D-2](#).

See [USB Keyboard FN 1 Substitution on page 5-14](#) to enable FN1 substitution for the USB HID keyboard.

Transmit “No Read” Message

Parameter # 5Eh

Scan a bar code below to select whether or not to transmit a No Read message. Enable this to transmit the characters NR when a successful decode does not occur before trigger release or the **Decode Session Timeout** expires. See [Decode Session Timeout on page 4-14](#). Disable this to send nothing to the host if a symbol does not decode.

- ✓ **NOTE** If you enable **Enable No Read**, and also enable Symbol Code ID Character or AIM Code ID Character for [Transmit Code ID Character on page 4-32](#), the digital scanner appends the code ID for Code 39 to the NR message.



Enable No Read
(01h)



* Disable No Read
(00h)

Chapter 5 USB Interface

Introduction

This chapter describes how to set up the digital scanner with a USB host. The digital scanner connects directly to a USB host, or a powered USB hub, which powers it. No additional power supply is required.

Throughout the programming bar code menus, asterisks (*) indicate default values.



*Indicates Default —

*HID Keyboard Emulation

— Feature/Option



NOTE Most computer monitors allow scanning the bar codes directly on the screen. When scanning from the screen, be sure to set the document magnification to a level where you can see the bar code clearly, and bars and/or spaces are not merging.

Connecting a USB Interface

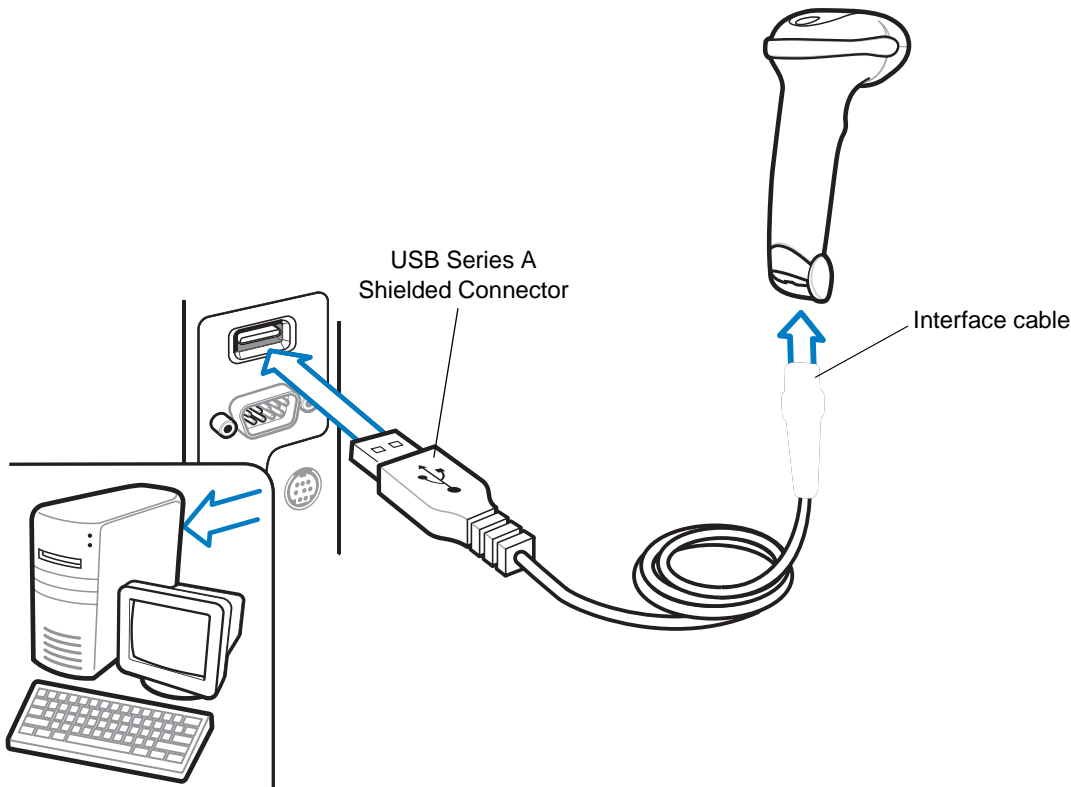

Figure 5-1 USB Connection.

- ✓ **NOTE** When connecting via USB use the shielded connector cable (e.g., p/n CBA-U21-S07ZAR). Refer to Solution Builder for guidance about cables. If upgrading an LS2208 or LS4208 to a DS4208, the shielded connector cable must be used.

The digital scanner connects with USB-capable hosts including:

- Desktop PCs and notebooks
 - Apple™ iMac, G4, iBooks (North America only)
 - IBM SurePOS terminals
- Sun, IBM, and other network computers that support more than one keyboard.

The following operating systems support the digital scanner through USB:

- Windows® 98, 2000, ME, XP
- MacOS 8.5 - MacOS 10.6

- ✓ **NOTE** If using a MacOS, the *USB Keystroke Delay* may need to be set to *Long Delay* (40 msec).

- IBM 4690 OS.

The digital scanner also interfaces with other USB hosts which support USB Human Interface Devices (HID).

To set up the digital scanner:

✓ **NOTE** Interface cables vary depending on configuration. The connectors illustrated in [Figure 5-1](#) are examples only. The connectors may be different than those illustrated, but the steps to connect the digital scanner are the same.

1. Connect the modular connector of the USB interface cable to the cable interface port on the digital scanner (see [Installing the Interface Cable on page 1-3](#)).
2. Plug the series A connector in the USB host or hub, or plug the Plus Power connector in an available port of the IBM SurePOS terminal.
3. Select the USB device type by scanning the appropriate bar code from [USB Device Type on page 5-5](#).
4. On first installation when using Windows, the software prompts to select or install the Human Interface Device driver. To install this driver, provided by Windows, click **Next** through all the choices and click **Finished** on the last choice. The digital scanner powers up during this installation.
5. To modify any other parameter options, scan the appropriate bar codes in this chapter.

If problems occur with the system, see [Troubleshooting on page 3-2](#).

USB Parameter Defaults

[Table 5-1](#) lists the defaults for USB host parameters. To change any option, scan the appropriate bar code(s) provided in the Parameter Descriptions section beginning on page [5-5](#).

✓ **NOTE** See [Appendix A, Standard Default Parameters](#) for all user preferences, hosts, symbologies, and miscellaneous default parameters.

Table 5-1 *USB Interface Parameter Defaults*

Parameter	Default	Page Number
USB Host Parameters		
USB Device Type	HID Keyboard Emulation	5-5
Symbol Native API (SNAPI) Status Handshaking	Enable	5-6
USB Country Keyboard Types (Country Codes)	North American	5-7
USB Keystroke Delay	No Delay	5-9
Simulated Caps Lock	Disable	5-10
USB CAPS Lock Override	Disable	5-10
USB Ignore Unknown Characters	Enable	5-11
USB Convert Unknown to Code 39	Disable	5-11
USB Ignore Beep Directive	Honor	5-12
USB Ignore Type Directive	Honor	5-12

Table 5-1 *USB Interface Parameter Defaults (Continued)*

Parameter	Default	Page Number
Emulate Keypad	Disable	5-13
Emulate Keypad with Leading Zero	Disable	5-13
USB FN1 Substitution	Disable	5-14
Function Key Mapping	Disable	5-14
Convert Case	None	5-15
USB Static CDC	Enable	5-15
USB Polling Interval	8 msec	5-16
Quick Keypad Emulation	Disable	5-18

USB Host Parameters

USB Device Type

Select the desired USB device type.

- ✓ **NOTE** When changing USB Device Types, the digital scanner automatically resets and issues the standard startup beep sequences.

- ✓ **NOTE** Before selecting **CDC COM Port Emulation**, install the CDC INF file on the host to ensure the scanner does not stall during power up (due to a failure to enumerate USB). If the scanner stalls, to recover it:
 - 1) Install the CDC INF file
or
 - 2) After power-up, hold the trigger for 10 seconds, which allows the scanner to power up using an alternate USB configuration. Upon power-up, scan another **USB Device Type**.

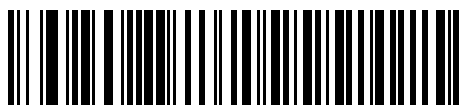

* HID Keyboard Emulation



IBM Table Top USB

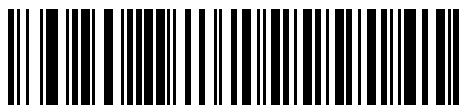

IBM Hand-Held USB



USB OPOS Handheld

USB Device Type (continued)



Simple COM Port Emulation

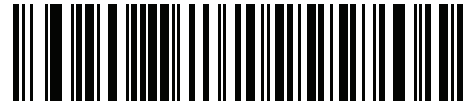

CDC COM Port Emulation



Symbol Native API (SNAPI) without Imaging Interface

Symbol Native API (SNAPI) Status Handshaking

After selecting a SNAPI interface as the USB device type, select whether to enable or disable status handshaking.



* Enable SNAPI Status Handshaking



Disable SNAPI Status Handshaking

USB Country Keyboard Types - Country Codes

Scan the bar code corresponding to the keyboard type. This setting applies only to the USB HID Keyboard Emulation device.

- ✓ **NOTE** When changing USB country keyboard types the digital scanner automatically resets and issues the standard startup beep sequences.

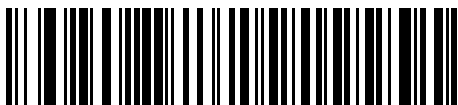

* North American Standard USB Keyboard



German Windows

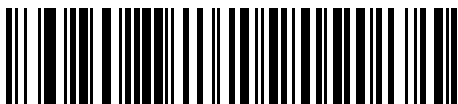

French Windows

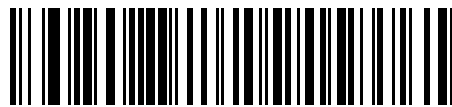

French Canadian Windows 95/98



French Canadian Windows 2000/XP

USB Country Keyboard Types - Country Codes (continued)

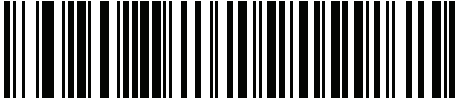

French Belgian Windows



Spanish Windows

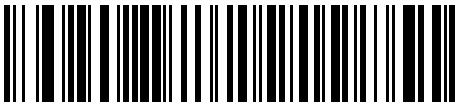

Italian Windows



Swedish Windows

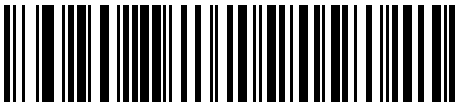

UK English Windows

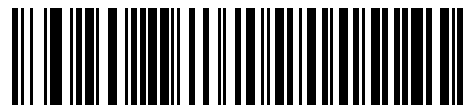

Japanese Windows (ASCII)

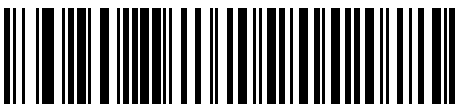

Portuguese-Brazilian Windows

USB Keystroke Delay

This parameter sets the delay, in milliseconds, between emulated keystrokes. Scan a bar code below to increase the delay when hosts require a slower transmission of data.



* No Delay



Medium Delay (20 msec)

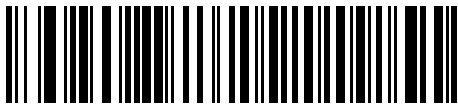

Long Delay (40 msec)

Simulated Caps Lock

Enable this to invert upper and lower case characters on the bar code as if the Caps Lock state is enabled on the keyboard. This inversion occurs regardless of the keyboard's **Caps Lock** state. Note that this only applies to alpha characters.

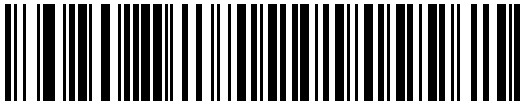

* Disable Simulated Caps Lock



Enable Simulated Caps Lock

USB CAPS Lock Override

This option applies only to the HID Keyboard Emulation device. Enable this to preserve the case of the data regardless of the state of the **Caps Lock** key. This setting is always enabled for the Japanese, Windows (ASCII) keyboard type and can not be disabled.

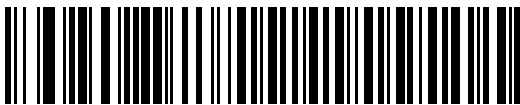

Override Caps Lock Key
(Enable)



* Do Not Override Caps Lock Key
(Disable)



NOTE If both Simulated Caps Lock and Caps Lock Override are enabled, Caps Lock Override takes precedence.

USB Ignore Unknown Characters

This option applies only to the HID Keyboard Emulation device and IBM device. Unknown characters are characters the host does not recognize. Select **Send Bar Codes With Unknown Characters** to send all bar code data except for unknown characters. The digital scanner issues no error beeps.

Select **Do Not Send Bar Codes With Unknown Characters**, for IBM devices, to prevent sending bar codes containing at least one unknown character to the host, or for HID Keyboard Emulation devices, this sends the bar code characters up to the unknown character. The digital scanner issues an error beep.



* **Send Bar Codes with Unknown Characters**
(Transmit)



Do Not Send Bar Codes with Unknown Characters
(Disable)

USB Convert Unknown to Code 39

This option applies only to the IBM Handheld, IBM Tabletop, and OPOS devices. Scan a bar code below to enable or disable converting unknown bar code type data to Code 39.



* **Disable Convert Unknown to Code 39**



Enable Convert Unknown to Code 39

USB Ignore Beep Directive

This applies only to IBM handheld, IBM tabletop, and OPOS devices. Scan one of the following bar codes to honor or ignore a beep directive. All directives are still acknowledged as if they were processed.

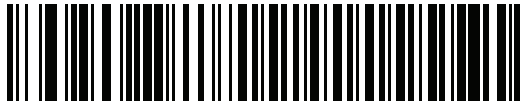

* Honor USB Beep Directive



Ignore USB Beep Directive

USB Ignore Type Directive

This applies only to IBM handheld, IBM tabletop, and OPOS devices. Scan one of the following bar codes to honor or ignore a code type enable/disable directive. All directives are still acknowledged as if they were processed.



* Honor USB Ignore Type Directive



Ignore USB Ignore Type Directive

Emulate Keypad

Enable this to send all characters as ASCII sequences over the numeric keypad. For example ASCII A transmits as "ALT make" 0 6 5 "ALT Break".



* Disable Keypad Emulation



Enable Keypad Emulation

Emulate Keypad with Leading Zero

Enable this to send character sequences sent over the numeric keypad as ISO characters which have a leading zero. For example ASCII A transmits as "ALT MAKE" 0 0 6 5 "ALT BREAK".



* Disable Keypad Emulation with Leading Zero



Enable Keypad Emulation with Leading Zero

USB Keyboard FN 1 Substitution

This option applies only to the USB HID Keyboard Emulation device. Enable this to replace any FN 1 characters in an EAN 128 bar code with a user-selected Key Category and value (see [FN1 Substitution Values on page 4-35](#) to set the Key Category and Key Value).



Enable



*** Disable**

Function Key Mapping

ASCII values under 32 are normally sent as a control-key sequences (see [Table 5-2 on page 5-19](#)). Enable this parameter to send the keys in bold in place of the standard key mapping. Table entries that do not have a bold entry remain the same whether or not you enable this parameter.

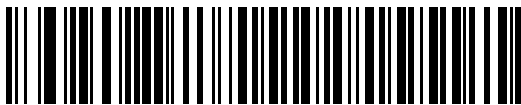

*** Disable Function Key Mapping**



Enable Function Key Mapping

Convert Case

Enable this to convert all bar code data to the selected case.

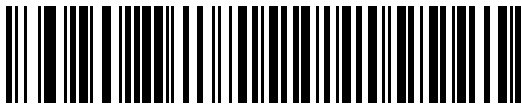

* No Case Conversion

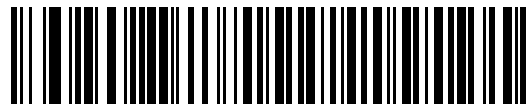

Convert All to Upper Case

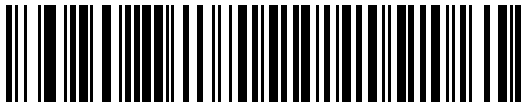

Convert All to Lower Case

USB Static CDC

When disabled, each device connected consumes another COM port (first device = COM1, second device = COM2, third device = COM3, etc.)

When enabled, each device connects to the same COM port.



* Enable USB Static CDC



Disable USB Static CDC

USB Polling Interval

This option applies only to the USB HID Keyboard Emulation Device. Scan a bar code below to set the polling interval. The polling interval determines the rate at which data can be sent between the scanner and the host computer. A lower number indicates a faster data rate.



CAUTION Ensure your host machine can handle the selected data rate. Selecting a data rate that is too fast for your host machine may result in lost data.

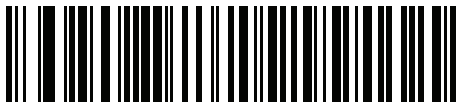

1 msec

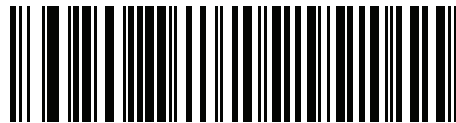

2 msec

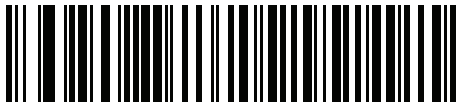

3msec



4 msec

USB Polling Interval (continued)



5 msec



6 msec

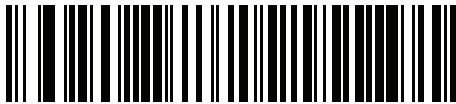

7 msec



* 8 msec

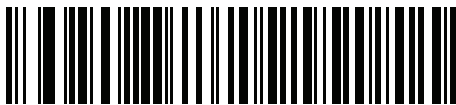

9 msec

Quick Keypad Emulation

This option applies only to the HID Keyboard Emulation Device and if Emulate Keypad is enabled. This parameter enables a quicker method of keypad emulation where ASCII sequences are only sent for ASCII characters not found on the keyboard. The default value is **Disable**.

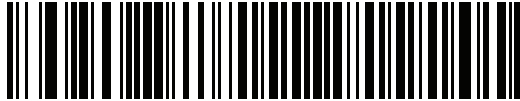

Enable

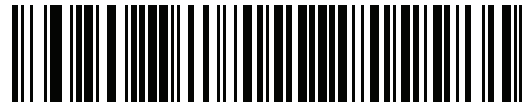

*** Disable**

ASCII Character Set for USB

Table 5-2 USB Prefix/Suffix Values

Prefix/ Suffix Value	Full ASCII Code 39 Encode Character	Keystroke
1000	%U	CTRL 2
1001	\$A	CTRL A
1002	\$B	CTRL B
1003	\$C	CTRL C
1004	\$D	CTRL D
1005	\$E	CTRL E
1006	\$F	CTRL F
1007	\$G	CTRL G
1008	\$H	CTRL H/ BACKSPACE ¹
1009	\$I	CTRL I/ HORIZONTAL TAB ¹
1010	\$J	CTRL J
1011	\$K	CTRL K
1012	\$L	CTRL L
1013	\$M	CTRL M/ ENTER ¹
1014	\$N	CTRL N
1015	\$O	CTRL O
1016	\$P	CTRL P
1017	\$Q	CTRL Q
1018	\$R	CTRL R
1019	\$S	CTRL S
1020	\$T	CTRL T
1021	\$U	CTRL U
1022	\$V	CTRL V
1023	\$W	CTRL W
1024	\$X	CTRL X

¹The keystroke in bold transmits only if you enable *Function Key Mapping* on page 5-14. Otherwise, the unbolded keystroke transmits.

Table 5-2 USB Prefix/Suffix Values (Continued)

Prefix/ Suffix Value	Full ASCII Code 39 Encode Character	Keystroke
1025	\$Y	CTRL Y
1026	\$Z	CTRL Z
1027	%A	CTRL [/ESC ¹
1028	%B	CTRL \
1029	%C	CTRL]
1030	%D	CTRL 6
1031	%E	CTRL -
1032	Space	Space
1033	/A	!
1034	/B	“
1035	/C	#
1036	/D	\$
1037	/E	%
1038	/F	&
1039	/G	‘
1040	/H	(
1041	/I)
1042	/J	*
1043	/K	+
1044	/L	,
1045	-	-
1046	.	.
1047	/O	/
1048	0	0
1049	1	1
1050	2	2
1051	3	3
1052	4	4

¹The keystroke in bold transmits only if you enable *Function Key Mapping* on page 5-14. Otherwise, the unbolded keystroke transmits.

Table 5-2 USB Prefix/Suffix Values (Continued)

Prefix/ Suffix Value	Full ASCII Code 39 Encode Character	Keystroke
1053	5	5
1054	6	6
1055	7	7
1056	8	8
1057	9	9
1058	/Z	:
1059	%F	;
1060	%G	<
1061	%H	=
1062	%I	>
1063	%J	?
1064	%V	@
1065	A	A
1066	B	B
1067	C	C
1068	D	D
1069	E	E
1070	F	F
1071	G	G
1072	H	H
1073	I	I
1074	J	J
1075	K	K
1076	L	L
1077	M	M
1078	N	N
1079	O	O
1080	P	P

¹The keystroke in bold transmits only if you enable *Function Key Mapping* on page 5-14. Otherwise, the unbolded keystroke transmits.

Table 5-2 USB Prefix/Suffix Values (Continued)

Prefix/ Suffix Value	Full ASCII Code 39 Encode Character	Keystroke
1081	Q	Q
1082	R	R
1083	S	S
1084	T	T
1085	U	U
1086	V	V
1087	W	W
1088	X	X
1089	Y	Y
1090	Z	Z
1091	%K	[
1092	%L	\
1093	%M]
1094	%N	^
1095	%O	_
1096	%W	`
1097	+A	a
1098	+B	b
1099	+C	c
1100	+D	d
1101	+E	e
1102	+F	f
1103	+G	g
1104	+H	h
1105	+I	i
1106	+J	j
1107	+K	k
1108	+L	l

¹The keystroke in bold transmits only if you enable *Function Key Mapping* on page 5-14. Otherwise, the unbolded keystroke transmits.

Table 5-2 USB Prefix/Suffix Values (Continued)

Prefix/ Suffix Value	Full ASCII Code 39 Encode Character	Keystroke
1109	+M	m
1110	+N	n
1111	+O	o
1112	+P	p
1113	+Q	q
1114	+R	r
1115	+S	s
1116	+T	t
1117	+U	u
1118	+V	v
1119	+W	w
1120	+X	x
1121	+Y	y
1122	+Z	z
1123	%P	{
1124	%Q	
1125	%R	}
1126	%S	~

¹The keystroke in bold transmits only if you enable *Function Key Mapping* on page 5-14. Otherwise, the unbolded keystroke transmits.

Table 5-3 *USB ALT Key Character Set*

ALT Keys	Keystroke
2064	ALT 2
2065	ALT A
2066	ALT B
2067	ALT C
2068	ALT D
2069	ALT E
2070	ALT F
2071	ALT G
2072	ALT H
2073	ALT I
2074	ALT J
2075	ALT K
2076	ALT L
2077	ALT M
2078	ALT N
2079	ALT O
2080	ALT P
2081	ALT Q
2082	ALT R
2083	ALT S
2084	ALT T
2085	ALT U
2086	ALT V
2087	ALT W
2088	ALT X
2089	ALT Y
2090	ALT Z

Table 5-4 *USB GUI Key Character Set*

GUI Key	Keystroke
3000	Right Control Key
3048	GUI 0
3049	GUI 1
3050	GUI 2
3051	GUI 3
3052	GUI 4
3053	GUI 5
3054	GUI 6
3055	GUI 7
3056	GUI 8
3057	GUI 9
3065	GUI A
3066	GUI B
3067	GUI C
3068	GUI D
3069	GUI E
3070	GUI F
3071	GUI G
3072	GUI H
3073	GUI I
3074	GUI J
3075	GUI K
3076	GUI L
3077	GUI M
3078	GUI N
3079	GUI O
3080	GUI P

Note: GUI Shift Keys - The Apple™ iMac keyboard has an apple key on either side of the space bar. Windows-based systems have a GUI key to the left of the left ALT key, and to the right of the right ALT key.

Table 5-4 USB GUI Key Character Set (Continued)

GUI Key	Keystroke
3081	GUI Q
3082	GUI R
3083	GUI S
3084	GUI T
3085	GUI U
3086	GUI V
3087	GUI W
3088	GUI X
3089	GUI Y
3090	GUI Z

Note: GUI Shift Keys - The Apple™ iMac keyboard has an apple key on either side of the space bar. Windows-based systems have a GUI key to the left of the left ALT key, and to the right of the right ALT key.

Table 5-5 *USB F Key Character Set*

F Keys	Keystroke
5001	F1
5002	F2
5003	F3
5004	F4
5005	F5
5006	F6
5007	F7
5008	F8
5009	F9
5010	F10
5011	F11
5012	F12
5013	F13
5014	F14
5015	F15
5016	F16
5017	F17
5018	F18
5019	F19
5020	F20
5021	F21
5022	F22
5023	F23
5024	F24

Table 5-6 *USB Numeric Keypad Character Set*

Numeric Keypad	Keystroke
6042	*
6043	+
6044	undefined
6045	-
6046	.
6047	/
6048	0
6049	1
6050	2
6051	3
6052	4
6053	5
6054	6
6055	7
6056	8
6057	9
6058	Enter
6059	Num Lock

Table 5-7 *USB Extended Keypad Character Set*

Extended Keypad	Keystroke
7001	Break
7002	Delete
7003	PgUp
7004	End
7005	Pg Dn
7006	Pause
7007	Scroll Lock
7008	Backspace
7009	Tab
7010	Print Screen
7011	Insert
7012	Home
7013	Enter
7014	Escape
7015	Up Arrow
7016	Down Arrow
7017	Left Arrow
7018	Right Arrow

Chapter 6 RS-232 Interface

Introduction

This chapter describes how to set up the digital scanner with an RS-232 host. Use the RS-232 interface to connect the digital scanner to point-of-sale devices, host computers, or other devices with an available RS-232 port (e.g., com port).

If your host does not appear in [Table 6-2](#), refer to the documentation for the host device to set communication parameters to match the host.

- ✓ **NOTE** The digital scanner uses TTL RS-232 signal levels, which interface with most system architectures. For system architectures requiring RS-232C signal levels, Motorola offers different cables providing TTL-to-RS-232C conversion. Contact Motorola Solutions Support for more information.

Throughout the programming bar code menus, asterisks (*) indicate default values.



* Indicates Default *Baud Rate 9600 — Feature/Option

- ✓ **NOTE** Most computer monitors allow scanning the bar codes directly on the screen. When scanning from the screen, be sure to set the document magnification to a level where you can see the bar code clearly, and bars and/or spaces are not merging.

Connecting an RS-232 Interface

Connect the digital scanner directly to the host computer.

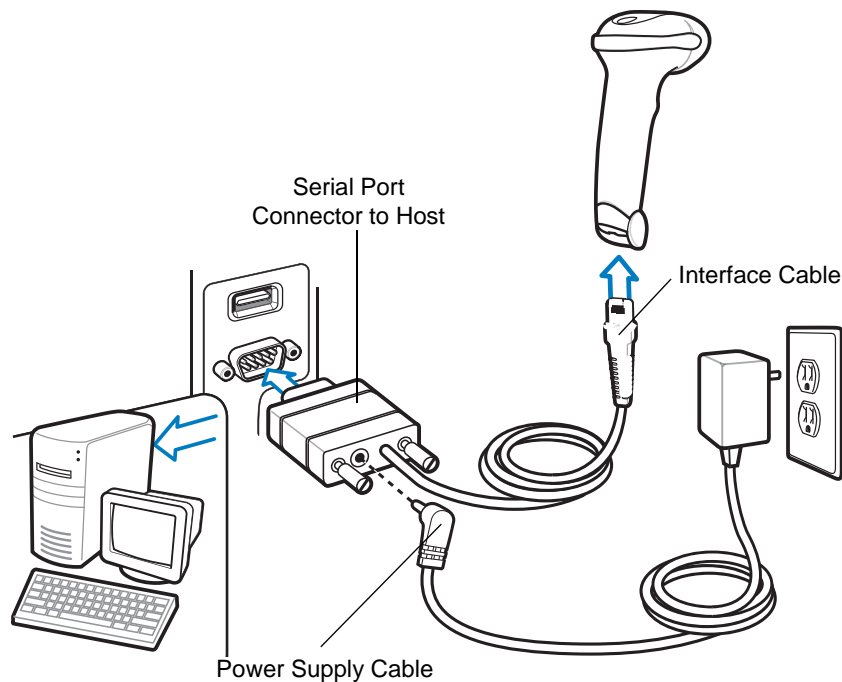

Figure 6-1 RS-232 Direct Connection

✓ **NOTE** Interface cables vary depending on configuration. The connectors illustrated in [Figure 6-1](#) are examples only. The connectors may be different than those illustrated, but the steps to connect the digital scanner are the same.

1. Attach the modular connector of the RS-232 interface cable to the cable interface port on the digital scanner (see [Installing the Interface Cable on page 1-3](#)).
2. Connect the other end of the RS-232 interface cable to the serial port on the host.
3. Connect the power supply to the serial connector end of the RS-232 interface cable. Plug the power supply into an appropriate outlet.
4. Select the RS-232 host type by scanning the appropriate bar code from [RS-232 Host Types on page 6-6](#).
5. To modify any other parameter options, scan the appropriate bar codes in this chapter.

RS-232 Parameter Defaults

[Table 6-1](#) lists the defaults for RS-232 host parameters. To change any option, scan the appropriate bar code(s) provided in the RS-232 Host Parameters section beginning on page [6-4](#).

✓ **NOTE** See [Appendix A, Standard Default Parameters](#) for all user preferences, hosts, symbologies, and miscellaneous default parameters.

Table 6-1 RS-232 Host Default Table

Parameter	Default	Page Number
RS-232 Host Parameters		
RS-232 Host Types	Standard	6-6
Baud Rate	9600	6-8
Parity Type	None	6-9
Data Bits	8-Bit	6-10
Stop Bits	1 Stop Bit	6-10
Check Receive Errors	Enable	6-11
Hardware Handshaking	None	6-11
Software Handshaking	None	6-13
Host Serial Response Time-out	2 Sec	6-15
RTS Line State	Low RTS	6-16
Beep on <BEL>	Disable	6-16
Intercharacter Delay	0 msec	6-17
Nixdorf Beep/LED Options	Normal Operation	6-18
Ignore Unknown Characters	Send Bar Code	6-18

Note: The DS4208 supports one stop bit only.

RS-232 Host Parameters

Various RS-232 hosts use their own parameter default settings. Selecting standard, ICL, Fujitsu, Wincor-Nixdorf Mode A, Wincor-Nixdorf Mode B, OPOS/JPOS, Olivetti, Omron, or Common Use Terminal Equipment (CUTE-LP/LG bar code readers) sets the defaults listed in [Table 6-2](#).

Table 6-2 Terminal Specific RS-232

Parameter	ICL	Fujitsu	Wincor-Nixdorf Mode A	Wincor-Nixdorf Mode B/OPOS/JPOS	Olivetti	Omron	CUTE
Transmit Code ID	Yes	Yes	Yes	Yes	Yes	Yes	Yes
Data Transmission Format	Data/Suffix	Data/Suffix	Data/Suffix	Data/Suffix	Prefix/Data/Suffix	Data/Suffix	Prefix/Data/Suffix
Suffix	CR (1013)	CR (1013)	CR (1013)	CR (1013)	ETX (1002)	CR (1013)	CR (1013) ETX (1003)
Baud Rate	9600	9600	9600	9600	9600	9600	9600
Parity	Even	None	Odd	Odd	Even	None	Even
Hardware Handshaking	RTS/CTS Option 3	None	RTS/CTS Option 3	RTS/CTS Option 3	None	None	None
Software Handshaking	None	None	None	None	ACK/NAK	None	None
Serial Response Time-out	9.9 Sec.	2 Sec.	None	None	9.9 Sec.	9.9 Sec.	9.9 Sec.
Stop Bit Select	One	One	One	One	One	One	One
ASCII Format	8-Bit	8-Bit	8-Bit	8-Bit	7-Bit	8-Bit	7-Bit
Beep On <BEL>	Disable	Disable	Disable	Disable	Disable	Disable	Disable
RTS Line State	High	Low	Low	Low = No data to send	Low	High	High
Prefix	None	None	None	None	STX (1003)	None	STX (1002)

In the Nixdorf Mode B, if CTS is low, scanning is disabled. When CTS is high, scanning is enabled. If you scan Nixdorf Mode B without connecting the digital scanner to the proper host, it may appear unable to scan. If this happens, scan a different RS-232 host type within 5 seconds of cycling power to the digital scanner. The CUTE host disables all parameter scanning, including Set Defaults. If you inadvertently select CUTE, scan * Enable Parameter Bar Code Scanning (01h) on page 4-5, then change the host selection.

RS-232 Host Parameters (continued)

Selecting ICL, Fujitsu, Wincor-Nixdorf Mode A, Wincor-Nixdorf Mode B, OPOS/JPOS, Olivetti, Omron, or Common Use Terminal Equipment (CUTE-LP/LG bar code readers) enables the transmission of code ID characters listed in [Table 6-3](#). These code ID characters are not programmable and are separate from the Transmit Code ID feature. Do not enable the Transmit Code ID feature for these terminals.

Table 6-3 Terminal Specific Code ID Characters

Code Type	ICL	Fujitsu	Wincor-Nixdorf Mode A	Wincor-Nixdorf Mode B/ OPOS/JPOS	Olivetti	Omron	CUTE
UPC-A	A	A	A	A	A	A	A
UPC-E	E	E	C	C	C	E	None
EAN-8/JAN-8	FF	FF	B	B	B	FF	None
EAN-13/JAN-13	F	F	A	A	A	F	A
Code 39	C <len>	None	M	M	M <len>	C <len>	3
Code 39 Full ASCII	None	None	M	M	None	None	3
Codabar	N <len>	None	N	N	N <len>	N <len>	None
Code 128	L <len>	None	K	K	K <len>	L <len>	5
I 2 of 5	I <len>	None	I	I	I <len>	I <len>	1
Code 93	None	None	L	L	L <len>	None	None
D 2 of 5	H <len>	None	H	H	H <len>	H <len>	2
GS1-128	L <len>	None	P	P	P <len>	L <len>	5
MSI	None	None	O	O	O <len>	None	None
Bookland EAN	F	F	A	A	A	F	None
Trioptic	None	None	None	None	None	None	None
Code 11	None	None	None	None	None	None	None
IATA	H<len>	None	H	H	H<len>	H<len>	2
Code 32	None	None	None	None	None	None	None
GS1 Databar Variants	None	None	E	E	None	None	None
PDF417	None	None	Q	Q	None	None	6
Datamatrix	None	None	R	R	None	None	4
QR Codes	None	None	U	U	None	None	7
Aztec/Aztec Rune	None	None	V	V	None	None	8
MAXICODE	None	None	T	T	None	None	None
microPDF	None	None	S	S	None	None	6

RS-232 Host Types

To select an RS-232 host interface, scan one of the following bar codes.



¹Scanning Standard RS-232 activates the RS-232 driver, but does not change port settings (e.g., parity, data bits, handshaking). Selecting another RS-232 host type bar code changes these settings.

RS-232 Host Types (continued)

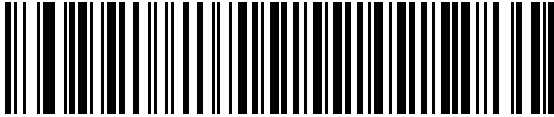

OPOS/JPOS

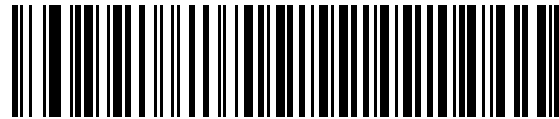

Fujitsu RS-232

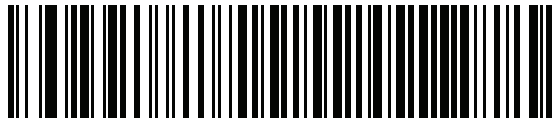

CUTE ¹

¹The CUTE host disables all parameter scanning, including Set Defaults. If you inadvertently select CUTE, scan [* Enable Parameter Bar Code Scanning \(01h\) on page 4-5](#), then change the host selection.

Baud Rate

Baud rate is the number of bits of data transmitted per second. Set the digital scanner's baud rate to match the baud rate setting of the host device. Otherwise, data may not reach the host device or may reach it in distorted form.

✓ **NOTE** The digital scanner does not support baud rates below 9600.



* Baud Rate 9600



Baud Rate 19,200



Baud Rate 38,400



Baud Rate 57,600



Baud Rate 115,200

Parity

A parity check bit is the most significant bit of each ASCII coded character. Select the parity type according to host device requirements.

- Select **Odd** parity to set the parity bit value to 0 or 1, based on data, to ensure that the coded character contains an odd number of 1 bits.
- Select **Even** parity to set the parity bit value is set to 0 or 1, based on data, to ensure that the coded character contains an even number of 1 bits.
- Select **None** when no parity bit is required.

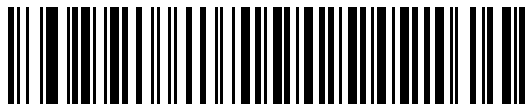

Odd

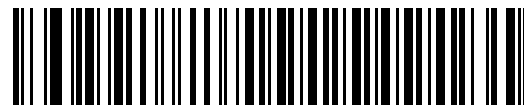

Even

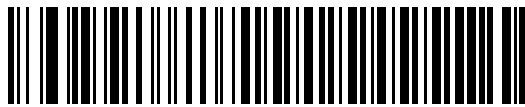

* None

Stop Bit Select

The stop bit(s) at the end of each transmitted character marks the end of transmission of one character and prepares the receiving device for the next character in the serial data stream. Select the number of stop bits (one or two) based on the number the receiving terminal is programmed to accommodate. Set the number of stop bits to match host device requirements.



Data Bits

This parameter allows the digital scanner to interface with devices requiring a 7-bit or 8-bit ASCII protocol.



Check Receive Errors

Select whether or not to check the parity, framing, and overrun of received characters. The parity value of received characters is verified against the parity parameter selected above.

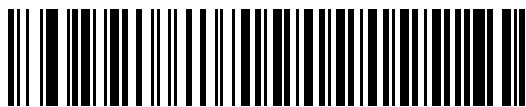

* Check For Received Errors



Do Not Check For Received Errors

Hardware Handshaking

The data interface consists of an RS-232 port designed to operate either with or without the hardware handshaking lines, *Request to Send* (RTS), and *Clear to Send* (CTS).

Disable Standard RTS/CTS handshaking to transmit scan data as it becomes available. Select Standard RTS/CTS handshaking to transmit scan data according to the following sequence:

- The digital scanner reads the CTS line for activity. If CTS is asserted, the scanner waits up to Host Serial Response Time-out for the host to de-assert the CTS line. If, after Host Serial Response Time-out (default), the CTS line is still asserted, the scanner sounds a transmit error, and discards any scanned data.
- When the CTS line is de-asserted, the digital scanner asserts the RTS line and waits up to Host Serial Response Time-out for the host to assert CTS. When the host asserts CTS, the scanner transmits data. If, after Host Serial Response Time-out (default), the CTS line is not asserted, the scanner sounds a transmit error, and discards the data.
- When data transmission completes, the digital scanner de-asserts RTS 10 msec after sending the last character.
- The host should respond by negating CTS. The digital scanner checks for a de-asserted CTS upon the next transmission of data.

During the transmission of data, the CTS line should be asserted. If CTS is deasserted for more than 50 ms between characters, the digital scanner aborts transmission, sounds a transmission error, and discards the data.

If this communication sequence fails, the digital scanner issues an error indication. In this case, the data is lost and must be rescanned.

If hardware handshaking and software handshaking are both enabled, hardware handshaking takes precedence.

✓ **NOTE** The DTR signal is jumpered to the active state.

Hardware Handshaking (continued)

- **None:** Scan this bar code to disable hardware handshaking.
- **Standard RTS/CTS:** Scan this bar code to select Standard RTS/CTS Hardware Handshaking.
- **RTS/CTS Option 1:** If you select RTS/CTS Option 1, the digital scanner asserts RTS before transmitting and ignores the state of CTS. The scanner de-asserts RTS when the transmission completes.
- **RTS/CTS Option 2:** If you select Option 2, RTS is always high or low (user-programmed logic level). However, the digital scanner waits for CTS to be asserted before transmitting data. If CTS is not asserted within Host Serial Response Time-out (default), the scanner issues an error indication and discards the data.
- **RTS/CTS Option 3:** If you select Option 3, the digital scanner asserts RTS prior to any data transmission, regardless of the state of CTS. The scanner waits up to Host Serial Response Time-out (default) for CTS to be asserted. If CTS is not asserted during this time, the scanner issues an error indication and discards the data. The digital scanner de-asserts RTS when transmission is complete.



* None



Standard RTS/CTS



RTS/CTS Option 1



RTS/CTS Option 2



RTS/CTS Option 3

Software Handshaking

This parameter offers control of the data transmission process in addition to, or instead of, that offered by hardware handshaking. There are five options.

If software handshaking and hardware handshaking are both enabled, hardware handshaking takes precedence.

- **None:** Select this to transmit data immediately. The digital scanner expects no response from the host.
- **ACK/NAK:** If you select this option, after transmitting data, the digital scanner expects either an ACK or NAK response from the host. When it receives a NAK, the scanner transmits the same data again and waits for either an ACK or NAK. After three unsuccessful attempts to send data after receiving NAKs, the digital scanner issues an error indication and discards the data.

The digital scanner waits up to the programmable Host Serial Response Time-out to receive an ACK or NAK. If the scanner does not get a response in this time, it issues an error indication and discards the data. There are no retries when a time-out occurs.

- **ENQ:** If you select this option, the digital scanner waits for an ENQ character from the host before transmitting data. If it does not receive an ENQ within the Host Serial Response Time-out, the digital scanner issues an error indication and discards the data. The host must transmit an ENQ character at least every Host Serial Response Time-out to prevent transmission errors.
- **ACK/NAK with ENQ:** This combines the two previous options. For re-transmissions of data, due to a NAK from the host, an additional ENQ is not required.
- **XON/XOFF:** An XOFF character turns the digital scanner transmission off until the scanner receives an XON character. There are two situations for XON/XOFF:
 - The digital scanner receives an XOFF before has data to send. When the scanner has data to send, it waits up to Host Serial Response Time-out for an XON character before transmission. If it does not receive the XON within this time, the digital scanner issues an error indication and discards the data.
 - The digital scanner receives an XOFF during a transmission. Data transmission then stops after sending the current byte. When the digital scanner receives an XON character, it sends the rest of the data message. The digital scanner waits indefinitely for the XON.

Software Handshaking (continued)



* None

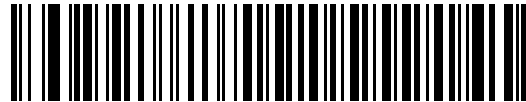

ACK/NAK

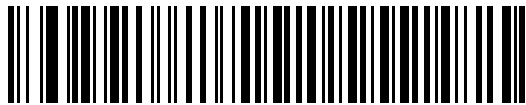

ENQ



ACK/NAK with ENQ



XON/XOFF

Host Serial Response Time-out

This parameter specifies how long the digital scanner waits for an ACK, NAK, or CTS before determining that a transmission error occurred. This only applies when in one of the ACK/NAK software handshaking modes, or RTS/CTS hardware handshaking mode.

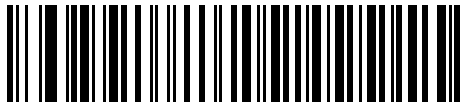

* Minimum: 2 Sec



Low: 2.5 Sec

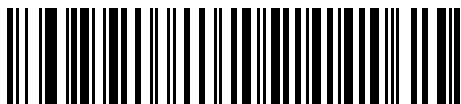

Medium: 5 Sec

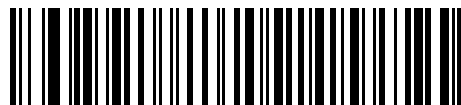

High: 7.5 Sec

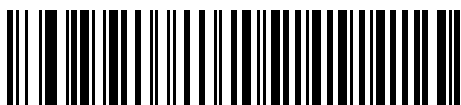

Maximum: 9.9 Sec

RTS Line State

This parameter sets the idle state of the Serial Host RTS line. Scan a bar code below to select **Low RTS** or **High RTS** line state.



* Host: Low RTS

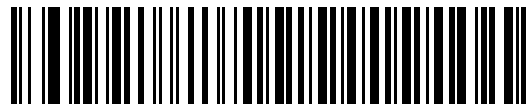

Host: High RTS

Beep on <BEL>

If you enable this parameter, the digital scanner issues a beep when it detects a <BEL> character on the RS-232 serial line. <BEL> indicates an illegal entry or other important event.

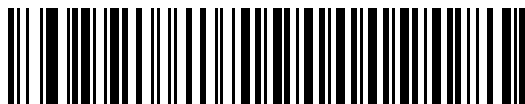

Beep On <BEL> Character
(Enable)

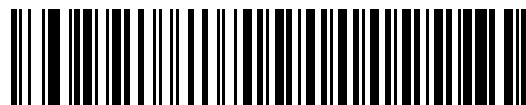

* Do Not Beep On <BEL> Character
(Disable)

Intercharacter Delay

This parameter specifies the intercharacter delay inserted between character transmissions.



* Minimum: 0 msec



Low: 25 msec

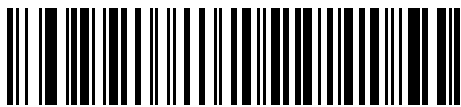

Medium: 50 msec



High: 75 msec

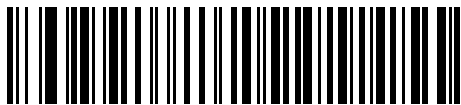

Maximum: 99 msec

Nixdorf Beep/LED Options

If you selected Nixdorf Mode B, this indicates when the digital scanner beeps and turns on its LED after a decode.



* Normal Operation
(Beep/LED immediately after decode)

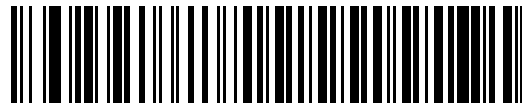

Beep/LED After Transmission

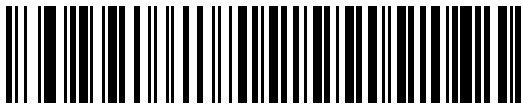

Beep/LED After CTS Pulse

Ignore Unknown Characters

Unknown characters are characters the host does not recognize. Select **Send Bar Codes with Unknown Characters** to send all bar code data except for unknown characters. The digital scanner issues no error beeps.

Select **Do Not Send Bar Codes With Unknown Characters** to send bar code data up to the first unknown character. The digital scanner issues an error beep.



* Send Bar Code
(with unknown characters)

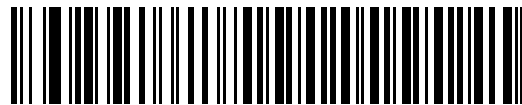

Do Not Send Bar Codes
(with unknown characters)

ASCII Character Set for RS-232

You can assign the values in [Table 6-4](#) as prefixes or suffixes for ASCII character data transmission.

Table 6-4 *Prefix/Suffix Values*

Prefix/Suffix Value	Full ASCII Code 39 Encode Character	ASCII Character
1000	%U	NUL
1001	\$A	SOH
1002	\$B	STX
1003	\$C	ETX
1004	\$D	EOT
1005	\$E	ENQ
1006	\$F	ACK
1007	\$G	BELL
1008	\$H	BCKSPC
1009	\$I	HORIZ TAB
1010	\$J	LF/NW LN
1011	\$K	VT
1012	\$L	FF
1013	\$M	CR/ENTER
1014	\$N	SO
1015	\$O	SI
1016	\$P	DLE
1017	\$Q	DC1/XON
1018	\$R	DC2
1019	\$S	DC3/XOFF
1020	\$T	DC4
1021	\$U	NAK
1022	\$V	SYN
1023	\$W	ETB
1024	\$X	CAN
1025	\$Y	EM
1026	\$Z	SUB

Table 6-4 *Prefix/Suffix Values (Continued)*

Prefix/Suffix Value	Full ASCII Code 39 Encode Character	ASCII Character
1027	%A	ESC
1028	%B	FS
1029	%C	GS
1030	%D	RS
1031	%E	US
1032	Space	Space
1033	/A	!
1034	/B	"
1035	/C	#
1036	/D	\$
1037	/E	%
1038	/F	&
1039	/G	'
1040	/H	(
1041	/I)
1042	/J	*
1043	/K	+
1044	/L	,
1045	-	-
1046	.	.
1047	/O	/
1048	0	0
1049	1	1
1050	2	2
1051	3	3
1052	4	4
1053	5	5
1054	6	6
1055	7	7
1056	8	8

Table 6-4 *Prefix/Suffix Values (Continued)*

Prefix/Suffix Value	Full ASCII Code 39 Encode Character	ASCII Character
1057	9	9
1058	/Z	:
1059	%F	;
1060	%G	<
1061	%H	=
1062	%I	>
1063	%J	?
1064	%V	@
1065	A	A
1066	B	B
1067	C	C
1068	D	D
1069	E	E
1070	F	F
1071	G	G
1072	H	H
1073	I	I
1074	J	J
1075	K	K
1076	L	L
1077	M	M
1078	N	N
1079	O	O
1080	P	P
1081	Q	Q
1082	R	R
1083	S	S
1084	T	T
1085	U	U
1086	V	V

Table 6-4 *Prefix/Suffix Values (Continued)*

Prefix/Suffix Value	Full ASCII Code 39 Encode Character	ASCII Character
1087	W	W
1088	X	X
1089	Y	Y
1090	Z	Z
1091	%K	[
1092	%L	\
1093	%M]
1094	%N	^
1095	%O	_
1096	%W	`
1097	+A	a
1098	+B	b
1099	+C	c
1100	+D	d
1101	+E	e
1102	+F	f
1103	+G	g
1104	+H	h
1105	+I	i
1106	+J	j
1107	+K	k
1108	+L	l
1109	+M	m
1110	+N	n
1111	+O	o
1112	+P	p
1113	+Q	q
1114	+R	r
1115	+S	s
1116	+T	t

Table 6-4 *Prefix/Suffix Values (Continued)*

Prefix/Suffix Value	Full ASCII Code 39 Encode Character	ASCII Character
1117	+U	u
1118	+V	v
1119	+W	w
1120	+X	x
1121	+Y	y
1122	+Z	z
1123	%P	{
1124	%Q	
1125	%R	}
1126	%S	~
1127		Undefined
7013		ENTER

Chapter 7 IBM 468X / 469X Interface

Introduction

This chapter describes how to set up the digital scanner with an IBM 468X/469X host.

Throughout the programming bar code menus, asterisks (*) indicate default values.



* Indicates Default — *** Disable Convert Unknown to Code 39** — Feature/Option



NOTE Most computer monitors allow scanning the bar codes directly on the screen. When scanning from the screen, be sure to set the document magnification to a level where you can see the bar code clearly, and bars and/or spaces are not merging.

Connecting to an IBM 468X/469X Host

Connect the digital scanner directly to the host interface.

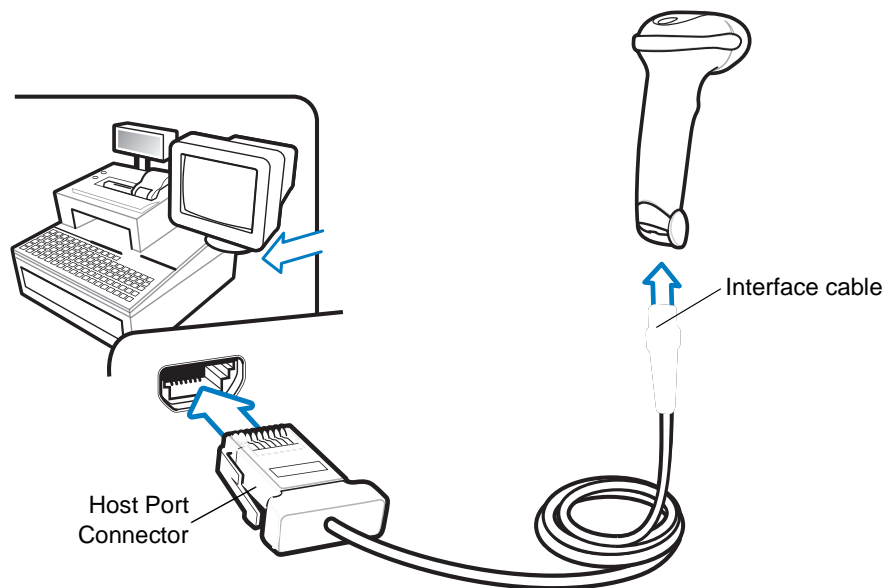

Figure 7-1 IBM Direct Connection

✓ **NOTE** Interface cables vary depending on configuration. The connectors illustrated in [Figure 7-1](#) are examples only. The connectors may be different than those illustrated, but the steps to connect the digital scanner are the same.

1. Attach the modular connector of the IBM 46XX interface cable to the cable interface port on the digital scanner. See [Installing the Interface Cable on page 1-3](#).
2. Connect the other end of the IBM 46XX interface cable to the appropriate port on the host (typically Port 9).
3. Select the port address by scanning the appropriate bar code from [Port Address on page 7-4](#).
4. To modify any other parameter options, scan the appropriate bar codes in this chapter.

✓ **NOTE** The only required configuration is the port address. The IBM system typically controls other digital scanner parameters.

IBM Parameter Defaults

[Table 7-1](#) lists the defaults for IBM host parameters. To change any option, scan the appropriate bar code(s) provided in the Parameter Descriptions section beginning on page [7-4](#).

✓ **NOTE** See [Appendix A, Standard Default Parameters](#) for all user preferences, hosts, symbologies, and miscellaneous default parameters.

Table 7-1 *IBM Host Default Table*

Parameter	Default	Page Number
IBM 468X/469X Host Parameters		
Port Address	None Selected	7-4
Convert Unknown to Code 39	Disable	7-5
Ignore Beep Directive	Honor	7-5
Ignore Configuration Directive	Honor	7-6

IBM 468X/469X Host Parameters

Port Address

This parameter sets the IBM 468X/469X port used.

✓ **NOTE** Scanning one of these bar codes enables the RS-485 interface on the digital scanner.

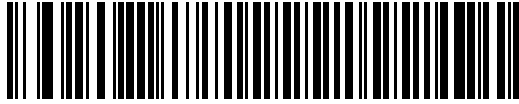

* None Selected

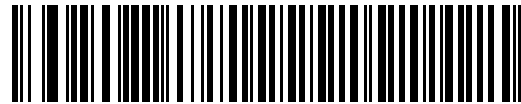

Hand-Held Scanner Emulation (Port 9B)

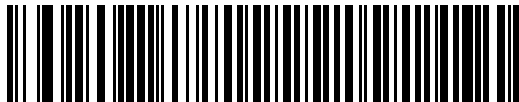

Non-IBM Scanner Emulation (Port 5B)

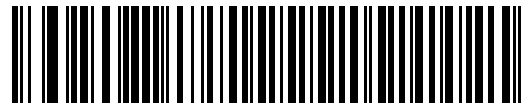
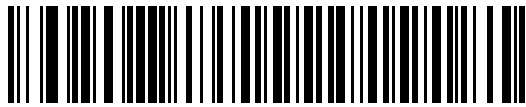

Table Top Scanner Emulation (Port 17)

Convert Unknown to Code 39

Scan a bar code below to enable or disable the conversion of unknown bar code type data to Code 39.



Enable Convert Unknown to Code 39

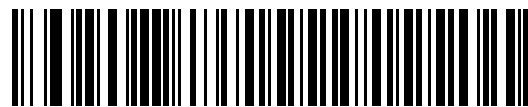

*** Disable Convert Unknown to Code 39**

Ignore Beep Directive

Scan one of the following bar codes to honor or ignore a beep directive made over the IBM RS-485 bus. All directives are still acknowledged to the IBM RS-485 host as if they were processed.

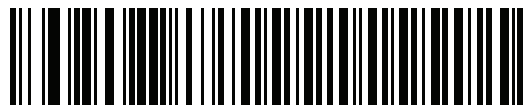

*** Honor Beep Directive**



Ignore Beep Directive

Ignore Configuration Directive

Scan one of the following bar codes to honor or ignore a code type enable/disable directive made over the IBM RS-485 bus. All directives are still acknowledged to the IBM RS-485 host as if they were processed.

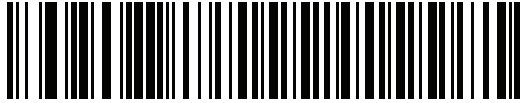

* Honor Configuration Directive



Ignore Configuration Directive

Chapter 8 Keyboard Wedge Interface

Introduction

This chapter describes how to set up a Keyboard Wedge interface with the digital scanner. With this interface, the digital scanner is connected between the keyboard and host computer, and translates bar code data into keystrokes. The host computer accepts the keystrokes as if they originated from the keyboard. This mode adds bar code reading functionality to a system designed for manual keyboard input. Keyboard keystrokes are simply passed through.

Throughout the programming bar code menus, asterisks (*) indicate default values.



* Indicates Default — *North American — Feature/Option

- ✓ **NOTE** Most computer monitors allow scanning the bar codes directly on the screen. When scanning from the screen, be sure to set the document magnification to a level where you can see the bar code clearly, and bars and/or spaces do not merge.

Connecting a Keyboard Wedge Interface

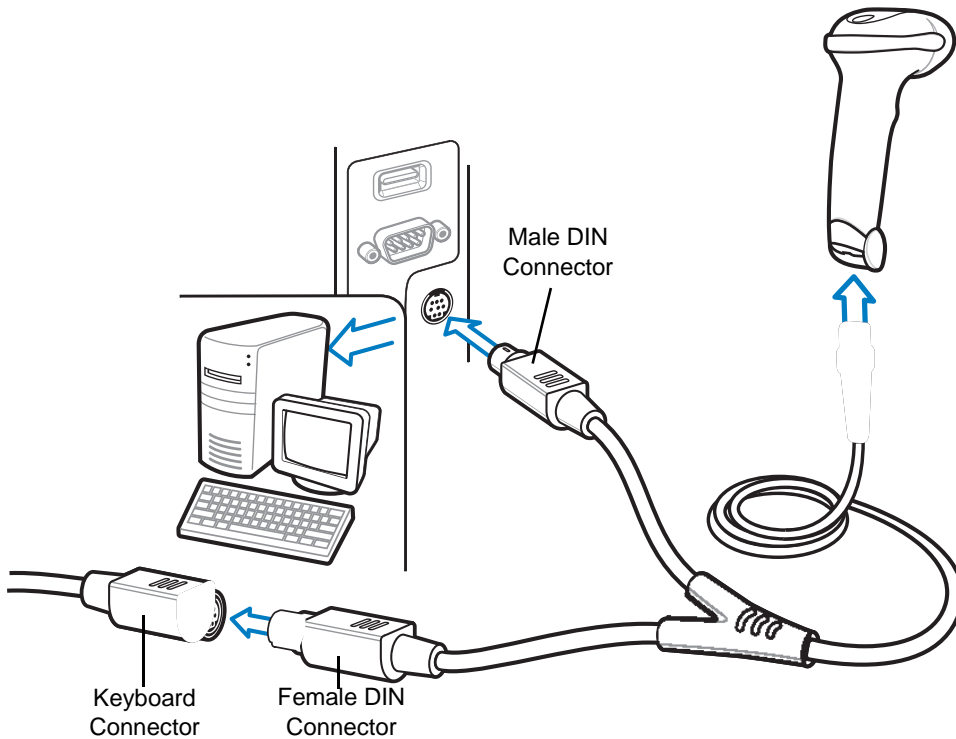

Figure 8-1 Keyboard Wedge Connection with Y-cable

To connect the Keyboard Wedge interface Y-cable:

✓ **NOTE** Interface cables vary depending on configuration. The connectors illustrated in [Figure 8-1](#) are examples only. The connectors may be different than those illustrated, but the steps to connect the digital scanner are the same.

1. Turn off the host and unplug the keyboard connector.
2. Attach the modular connector of the Y-cable to the cable interface port on the digital scanner. See [Installing the Interface Cable on page 1-3](#).
3. Connect the round male DIN host connector of the Y-cable to the keyboard port on the host device.
4. Connect the round female DIN keyboard connector of the Y-cable to the keyboard connector.
5. If needed, attach the optional power supply to the connector in the middle of the Y-cable.
6. Ensure that all connections are secure.
7. Turn on the host system.
8. Select the Keyboard Wedge host type by scanning the appropriate bar code from [Keyboard Wedge Host Types on page 8-4](#).
9. To modify any other parameter options, scan the appropriate bar codes in this chapter.

Keyboard Wedge Parameter Defaults

Table 8-1 lists the defaults for Keyboard Wedge host parameters. To change any option, scan the appropriate bar code(s) in the Keyboard Wedge Host Parameters section beginning on page [8-4](#).

✓ **NOTE** See [Appendix A, Standard Default Parameters](#) for all user preferences, hosts, symbologies, and miscellaneous default parameters.

Table 8-1 *Keyboard Wedge Host Default Table*

Parameter	Default	Page Number
Keyboard Wedge Host Parameters		
Keyboard Wedge Host Type	IBM PC/AT& IBM PC Compatibles	8-4
Country Types (Country Codes)	North American	8-5
Ignore Unknown Characters	Transmit	8-7
Keystroke Delay	No Delay	8-7
Intra-Keystroke Delay	Disable	8-8
Alternate Numeric Keypad Emulation	Disable	8-8
Simulated Caps Lock	Disable	8-9
Caps Lock Override	Disable	8-9
Convert Wedge Case	No Convert	8-10
Function Key Mapping	Disable	8-10
FN1 Substitution	Disable	8-11
Send Make and Break	Send	8-11

Keyboard Wedge Host Parameters

Keyboard Wedge Host Types

Select the Keyboard Wedge host by scanning one of the bar codes below.

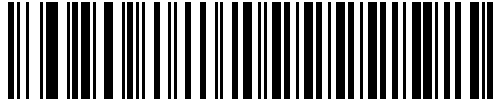

IBM PC/AT & IBM PC Compatibles



IBM AT Notebook

Keyboard Wedge Country Types - Country Codes

Scan the bar code corresponding to the keyboard type. If your keyboard type does not appear, see [Alternate Numeric Keypad Emulation on page 8-8](#).

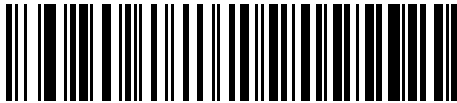

* North American



German Windows

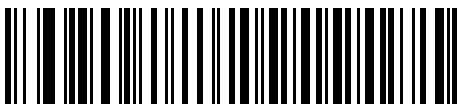

French Windows



French Canadian Windows 95/98

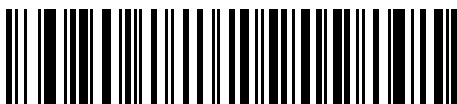

French Canadian Windows XP/2000



French Belgian Windows

Keyboard Wedge Country Types - Country Codes (continued)



Spanish Windows

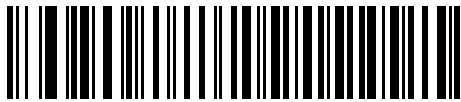

Italian Windows

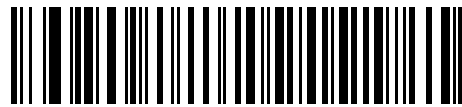

Swedish Windows



UK English Windows



Japanese Windows

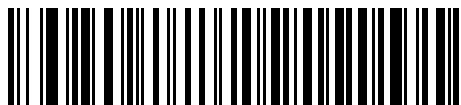

Portuguese-Brazilian Windows

Ignore Unknown Characters

Unknown characters are characters the host does not recognize. Select **Send Bar Codes With Unknown Characters** to send all bar code data except for unknown characters. The digital scanner issues no error beeps.

Select **Do Not Send Bar Codes With Unknown Characters** to send bar code data up to the first unknown character. The digital scanner issues an error beep.



* **Send Bar Codes with Unknown Characters
(Transmit)**



Do Not Send Bar Codes with Unknown Characters

Keystroke Delay

This is the delay in milliseconds between emulated keystrokes. Scan a bar code below to increase the delay when hosts require a slower transmission of data.

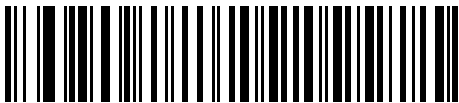

* **No Delay**



Medium Delay (20 msec)

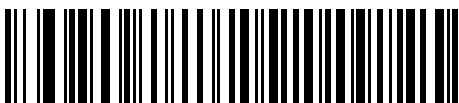

Long Delay (40 msec)

Intra-Keystroke Delay

Enable this to insert an additional delay between each emulated key depression and release. This sets the Keystroke Delay parameter to a minimum of 5 msec as well.

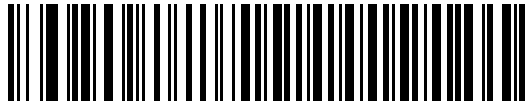

Enable

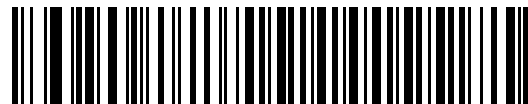

* Disable

Alternate Numeric Keypad Emulation

This allows emulation of most other country keyboard types not listed in [Keyboard Wedge Country Types - Country Codes on page 8-5](#) in a Microsoft® operating system environment.



Enable Alternate Numeric Keypad

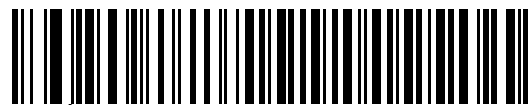

* Disable Alternate Numeric Keypad

Simulated Caps Lock

Enable this to invert upper and lower case characters on the bar code as if the Caps Lock state is enabled on the keyboard. This inversion occurs regardless of the keyboard's **Caps Lock** state. Note that this only applies to alpha characters.



Enable Caps Lock On

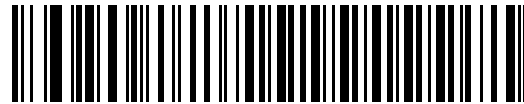

* Disable Caps Lock On

Caps Lock Override

Enable this on AT or AT Notebook hosts to preserve the case of the data regardless of the state of the **Caps Lock** key. Therefore, an 'A' in the bar code transmits as an 'A' regardless of the setting of the keyboard's **Caps Lock** key.

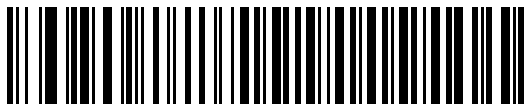

Enable Caps Lock Override



* Disable Caps Lock Override



NOTE If both Simulated Caps Lock and Caps Lock Override are enabled, Caps Lock Override takes precedence.

Convert Wedge Case

Enable this to convert all bar code data to the selected case.



Convert to Upper Case

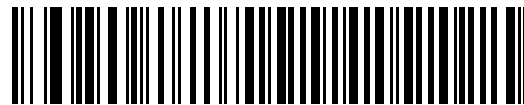

Convert to Lower Case

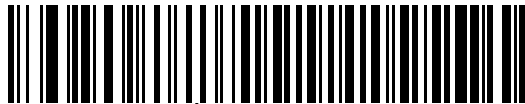

* No Convert

Function Key Mapping

ASCII values under 32 are normally sent as control key sequences (see [Table 8-2 on page 8-13](#)). Enable this parameter to send the keys in bold in place of the standard key mapping. Table entries that do not have a bold entry remain the same whether or not you enable this parameter.



Enable



* Disable

FN1 Substitution

Enable this to replace FN1 characters in an EAN128 bar code with a user-selected keystroke (see [FN1 Substitution Values on page 4-35](#)).



Enable



* Disable

Send Make and Break

Enable this to prevent sending the scan codes for releasing a key.



* Send Make and Break Scan Codes



Send Make Scan Code Only



NOTE Windows-based systems must use **Send Make and Break Scan Codes**.

Keyboard Maps

Refer to the following keyboard maps for prefix/suffix keystroke parameters. To program the prefix/suffix values, see the bar codes on [page 4-33](#).

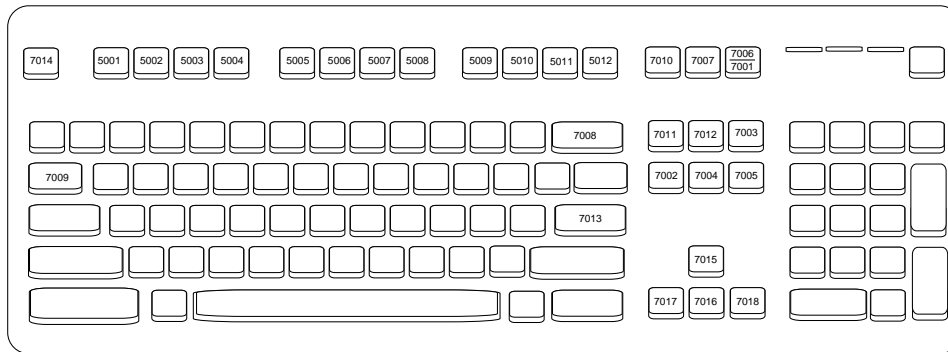

Figure 8-2 IBM PS2 Type Keyboard

ASCII Character Set for Keyboard Wedge

- ✓ **NOTE** Code 39 Full ASCII interprets the bar code special character (\$ + % /) preceding a Code 39 character and assigns an ASCII character value to the pair. For example, if you enable Code 39 Full ASCII and scan **+B**, it transmits as **b**, **%J** as **?**, and **%V** as **@**. Scanning **ABC%I** outputs the keystroke equivalent of **ABC >**.

Table 8-2 Keyboard Wedge ASCII Character Set

ASCII Value	Full ASCII Code 39 Encode Character	Keystroke
1001	\$A	CTRL A
1002	\$B	CTRL B
1003	\$C	CTRL C
1004	\$D	CTRL D
1005	\$E	CTRL E
1006	\$F	CTRL F
1007	\$G	CTRL G
1008	\$H	CTRL H/ BACKSPACE ¹
1009	\$I	CTRL I/ HORIZONTAL TAB ¹
1010	\$J	CTRL J
1011	\$K	CTRL K
1012	\$L	CTRL L
1013	\$M	CTRL M/ ENTER ¹
1014	\$N	CTRL N
1015	\$O	CTRL O
1016	\$P	CTRL P
1017	\$Q	CTRL Q
1018	\$R	CTRL R
1019	\$S	CTRL S
1020	\$T	CTRL T
1021	\$U	CTRL U
1022	\$V	CTRL V
1023	\$W	CTRL W

¹The keystroke in bold transmits only if you enabled *Function Key Mapping* on page 8-10. Otherwise, the unbolded keystroke transmits.

Table 8-2 Keyboard Wedge ASCII Character Set (Continued)

ASCII Value	Full ASCII Code 39 Encode Character	Keystroke
1024	\$X	CTRL X
1025	\$Y	CTRL Y
1026	\$Z	CTRL Z
1027	%A	CTRL [/ ESC ¹
1028	%B	CTRL \
1029	%C	CTRL]
1030	%D	CTRL 6
1031	%E	CTRL -
1032	Space	Space
1033	/A	!
1034	/B	"
1035	/C	#
1036	/D	\$
1037	/E	%
1038	/F	&
1039	/G	'
1040	/H	(
1041	/I)
1042	/J	*
1043	/K	+
1044	/L	,
1045	-	-
1046	.	.
1047	/O	/
1048	0	0
1049	1	1
1050	2	2
1051	3	3

¹The keystroke in bold transmits only if you enabled *Function Key Mapping* on page 8-10. Otherwise, the unbolded keystroke transmits.

Table 8-2 Keyboard Wedge ASCII Character Set (Continued)

ASCII Value	Full ASCII Code 39 Encode Character	Keystroke
1052	4	4
1053	5	5
1054	6	6
1055	7	7
1056	8	8
1057	9	9
1058	/Z	:
1059	%F	;
1060	%G	<
1061	%H	=
1062	%I	>
1063	%J	?
1064	%V	@
1065	A	A
1066	B	B
1067	C	C
1068	D	D
1069	E	E
1070	F	F
1071	G	G
1072	H	H
1073	I	I
1074	J	J
1075	K	K
1076	L	L
1077	M	M
1078	N	N
1079	O	O

¹The keystroke in bold transmits only if you enabled *Function Key Mapping* on page 8-10. Otherwise, the unbolded keystroke transmits.

Table 8-2 Keyboard Wedge ASCII Character Set (Continued)

ASCII Value	Full ASCII Code 39 Encode Character	Keystroke
1080	P	P
1081	Q	Q
1082	R	R
1083	S	S
1084	T	T
1085	U	U
1086	V	V
1087	W	W
1088	X	X
1089	Y	Y
1090	Z	Z
1091	%K	[
1092	%L	\
1093	%M]
1094	%N	^
1095	%O	_
1096	%W	'
1097	+A	a
1098	+B	b
1099	+C	c
1100	+D	d
1101	+E	e
1102	+F	f
1103	+G	g
1104	+H	h
1105	+I	i
1106	+J	j
1107	+K	k

¹The keystroke in bold transmits only if you enabled *Function Key Mapping* on page 8-10. Otherwise, the unbolded keystroke transmits.

Table 8-2 Keyboard Wedge ASCII Character Set (Continued)

ASCII Value	Full ASCII Code 39 Encode Character	Keystroke
1108	+L	l
1109	+M	m
1110	+N	n
1111	+O	o
1112	+P	p
1113	+Q	q
1114	+R	r
1115	+S	s
1116	+T	t
1117	+U	u
1118	+V	v
1119	+W	w
1120	+X	x
1121	+Y	y
1122	+Z	z
1123	%P	{
1124	%Q	
1125	%R	}
1126	%S	~

¹The keystroke in bold transmits only if you enabled *Function Key Mapping* on page 8-10. Otherwise, the unbolded keystroke transmits.

Table 8-3 Keyboard Wedge ALT Key Character Set

ALT Keys	Keystroke
2065	ALT A
2066	ALT B
2067	ALT C
2068	ALT D
2069	ALT E
2070	ALT F
2071	ALT G

Table 8-3 Keyboard Wedge ALT Key Character Set (Continued)

ALT Keys	Keystroke
2072	ALT H
2073	ALT I
2074	ALT J
2075	ALT K
2076	ALT L
2077	ALT M
2078	ALT N
2079	ALT O
2080	ALT P
2081	ALT Q
2082	ALT R
2083	ALT S
2084	ALT T
2085	ALT U
2086	ALT V
2087	ALT W
2088	ALT X
2089	ALT Y
2090	ALT Z

Table 8-4 Keyboard Wedge GUI Key Character Set

GUI Keys	Keystrokes
3000	Right Control Key
3048	GUI 0
3049	GUI 1
3050	GUI 2
3051	GUI 3
3052	GUI 4
3053	GUI 5
3054	GUI 6
3055	GUI 7

Table 8-4 Keyboard Wedge GUI Key Character Set (Continued)

GUI Keys	Keystrokes
3056	GUI 8
3057	GUI 9
3065	GUI A
3066	GUI B
3067	GUI C
3068	GUI D
3069	GUI E
3070	GUI F
3071	GUI G
3072	GUI H
3073	GUI I
3074	GUI J
3075	GUI K
3076	GUI L
3077	GUI M
3078	GUI N
3079	GUI O
3080	GUI P
3081	GUI Q
3082	GUI R
3083	GUI S
3084	GUI T
3085	GUI U
3086	GUI V
3087	GUI W
3088	GUI X
3089	GUI Y
3090	GUI Z

Table 8-5 Keyboard Wedge F Key Character Set

F Keys	Keystroke
5001	F1
5002	F2
5003	F3
5004	F4
5005	F5
5006	F6
5007	F7
5008	F8
5009	F9
5010	F10
5011	F11
5012	F12
5013	F13
5014	F14
5015	F15
5016	F16
5017	F17
5018	F18
5019	F19
5020	F20
5021	F21
5022	F22
5023	F23
5024	F24

Table 8-6 Keyboard Wedge Numeric Keypad Character Set

Numeric Keypad	Keystroke
6042	*
6043	+
6044	undefined
6045	-

Table 8-6 Keyboard Wedge Numeric Keypad Character Set (Continued)

Numeric Keypad	Keystroke
6046	.
6047	/
6048	0
6049	1
6050	2
6051	3
6052	4
6053	5
6054	6
6055	7
6056	8
6057	9
6058	Enter
6059	Num Lock

Table 8-7 Keyboard Wedge Extended Keypad Character Set

Extended Keypad	Keystroke
7001	Break
7002	Delete
7003	Pg Up
7004	End
7005	Pg Dn
7006	Pause
7007	Scroll Lock
7008	Backspace
7009	Tab
7010	Print Screen
7011	Insert
7012	Home
7013	Enter
7014	Escape

Table 8-7 *Keyboard Wedge Extended Keypad Character Set (Continued)*

Extended Keypad	Keystroke
7015	Up Arrow
7016	Dn Arrow
7017	Left Arrow
7018	Right Arrow

Chapter 9 Symbologies

Introduction

This chapter describes symbology features and provides programming bar codes for selecting these features. Before programming, follow the instructions in [Chapter 1, Getting Started](#).

To set feature values, scan a single bar code or a short bar code sequence. The settings are stored in non-volatile memory and are preserved even when the digital scanner powers down.

✓ **NOTE** Most computer monitors allow scanning the bar codes directly on the screen. When scanning from the screen, be sure to set the document magnification to a level where you can see the bar code clearly, and bars and/or spaces do not merge.

Select a host type (see each host chapter for specific host information) after the power-up beeps sound. This is only necessary upon the first power-up when connected to a new host.

To return all features to default values, scan the [Set Default Parameter on page 4-4](#). Throughout the programming bar code menus, asterisks (*) indicate default values.



* Indicates Default — *Enable UPC-A — Feature/Option
(01h) — Option Hex Value

Scanning Sequence Examples

In most cases, scanning one bar code sets the parameter value. For example, to transmit bar code data without the UPC-A check digit, simply scan the **Do Not Transmit UPC-A Check Digit** bar code under [Transmit UPC-A Check Digit on page 9-17](#). The digital scanner issues a fast warble beep and the LED turns green, signifying a successful parameter entry.

Other parameters, such as **Set Length(s) for D 2 of 5** require scanning several bar codes. See the individual parameter, such as **Set Length(s) for D 2 of 5**, for this procedure.

Errors While Scanning

Unless otherwise specified, to correct an error during a scanning sequence, just re-scan the correct parameter.

Symbology Parameter Defaults

[Table 9-1](#) lists the defaults for all symbologies parameters. To change the default values, scan the appropriate bar codes in this guide. These new values replace the standard default values in memory. To recall the default parameter values, scan the [Set Default Parameter on page 4-4](#).

✓ **NOTE** See [Appendix A, Standard Default Parameters](#) for all user preferences, hosts, and miscellaneous default parameters.

Table 9-1 *Parameter Defaults*

Parameter	Parameter Number	Default	Page Number
Disable All Code Types			9-7
UPC/EAN			
UPC-A	01h	Enable	9-8
UPC-E	02h	Enable	9-8
UPC-E1	0Ch	Disable	9-9
EAN-8/JAN 8	04h	Enable	9-9
EAN-13/JAN 13	03h	Enable	9-10
Bookland EAN	53h	Enable	9-10
Bookland ISBN Format	F1h 40h	ISBN-10	9-11
Decode UPC/EAN/JAN Supplementals (2 and 5 digits)	10h	Ignore	9-13
User-Programmable Supplementals		N/A	9-15
Supplemental 1:	F1h 43h		
Supplemental 2:	F1h 44h		
UPC/EAN/JAN Supplemental Redundancy	50h	10	9-15
Decode UPC/EAN/JAN Supplemental AIM ID	F1h A0h	Combined	9-16
Transmit UPC-A Check Digit	28h	Enable	9-17
Transmit UPC-E Check Digit	29h	Enable	9-17
Transmit UPC-E1 Check Digit	2Ah	Enable	9-18
UPC-A Preamble	22h	System Character	9-18
UPC-E Preamble	23h	System Character	9-18

Table 9-1 *Parameter Defaults (Continued)*

Parameter	Parameter Number	Default	Page Number
UPC-E1 Preamble	24h	System Character	9-20
Convert UPC-E to A	25h	Disable	9-21
Convert UPC-E1 to A	26h	Disable	9-21
EAN-8/JAN-8 Extend	27h	Disable	9-22
UCC Coupon Extended Code	55h	Disable	9-22
Coupon Report	F1h DAh	New Coupon Symbols	9-23
ISSN EAN	F1h 69h	Enable	9-24
Code 128			
Code 128	08h	Enable	9-25
Set Length(s) for Code 128	D1h, D2h	Any Length	9-25
GS1-128 (formerly UCC/EAN-128)	0Eh	Enable	9-26
ISBT 128	54h	Enable	9-27
ISBT Concatenation	F1h 41h	Disable	9-28
Check ISBT Table	F1h 42h	Enable	9-29
ISBT Concatenation Redundancy	DFh	10	9-29
Code 39			
Code 39	00h	Enable	9-30
Trioptic Code 39	0Dh	Disable	9-30
Convert Code 39 to Code 32 (Italian Pharmacy Code)	56h	Disable	9-31
Code 32 Prefix	E7h	Disable	9-31
Set Length(s) for Code 39	12h 13h	Length Within Range: 2 to 55	9-32
Code 39 Check Digit Verification	30h	Disable	9-33
Transmit Code 39 Check Digit	2Bh	Disable	9-33
Code 39 Full ASCII Conversion	11h	Disable	9-34
Buffer Code 39	71h	Disable	9-35
Code 93			
Code 93	09h	Disable	9-37
Set Length(s) for Code 93	1Ah, 1Bh	Length Within Range: 4 to 55	9-37

Table 9-1 *Parameter Defaults (Continued)*

Parameter	Parameter Number	Default	Page Number
Code 11			
Code 11	0Ah	Disable	9-39
Set Lengths for Code 11	1Ch, 1Dh	Length Within Range: 4 to 55	9-39
Code 11 Check Digit Verification	34h	Disable	9-41
Transmit Code 11 Check Digit(s)	2Fh	Disable	9-42
Interleaved 2 of 5 (ITF)			
Interleaved 2 of 5 (ITF)	06h	Disable	9-42
Set Lengths for I 2 of 5	16h, 17h	1 Length; Length = 14	9-43
I 2 of 5 Check Digit Verification	31h	Disable	9-45
Transmit I 2 of 5 Check Digit	2Ch	Disable	9-45
Convert I 2 of 5 to EAN 13	52h	Disable	9-46
Discrete 2 of 5 (DTF)			
Discrete 2 of 5	05h	Disable	9-46
Set Length(s) for D 2 of 5	14h, 15h	1 Length; Length = 12	9-47
Codabar (NW - 7)			
Codabar	07h	Disable	9-49
Set Lengths for Codabar	18h, 19h	Length Within Range: 5 to 55	9-49
CLSI Editing	36h	Disable	9-51
NOTIS Editing	37h	Disable	9-51
MSI			
MSI	0Bh	Disable	9-52
Set Length(s) for MSI	1Eh, 1Fh	Length Within Range: 4 to 55	9-52
MSI Check Digits	32h	One	9-54
Transmit MSI Check Digit	2Eh	Disable	9-54
MSI Check Digit Algorithm	33h	Mod 10/Mod 10	9-55
Chinese 2 of 5			
Chinese 2 of 5	F0h 98h	Disable	9-55

Table 9-1 *Parameter Defaults (Continued)*

Parameter	Parameter Number	Default	Page Number
Matrix 2 of 5			
Matrix 2 of 5	F1h 6Ah	Disable	9-56
Matrix 2 of 5 Lengths	F1h 6Bh F1h 6Ch	Length; Length = 14	9-57
Matrix 2 of 5 Check Digit	F1h 6Eh	Disable	9-58
Transmit Matrix 2 of 5 Check Digit	F1h 6Fh	Disable	9-58
Korean 3 of 5			
Korean 3 of 5	F1h 45h	Disable	9-59
Inverse 1D			
	F1h 4Ah	Regular	9-60
Postal Codes			
US Postnet	59h	Disable	9-61
US Planet	5Ah	Disable	9-61
Transmit US Postal Check Digit	5Fh	Enable	9-62
UK Postal	5Bh	Disable	9-62
Transmit UK Postal Check Digit	60h	Enable	9-63
Japan Postal	F0h 22h	Disable	9-63
Australia Post	F0h 23h	Disable	9-64
Australia Post Format	F1h CEh	Autodiscriminate	9-65
Netherlands KIX Code	F0h 46h	Disable	9-66
USPS 4CB/One Code/Intelligent Mail	F1h 50h	Disable	9-66
UPU FICS Postal	F1h 63h	Disable	9-67
GS1 DataBar			
GS1 DataBar (GS1 DataBar Omnidirectional, GS1 DataBar Truncated, GS1 DataBar Stacked, GS1 DataBar Stacked Omnidirectional)	F0h 52h	Enable	9-68
GS1 DataBar Limited	F0h 53h	Disable	9-69
GS1 DataBar Limited Security Level	F1h D8h	3	9-70
GS1 DataBar Expanded (GS1 DataBar Expanded, GS1 DataBar Expanded Stacked)	F0h 54h	Enable	9-71
Convert GS1 DataBar to UPC/EAN	F0h 8Dh	Disable	9-72

Table 9-1 *Parameter Defaults (Continued)*

Parameter	Parameter Number	Default	Page Number
Composite			
Composite CC-C	F0h 55h	Disable	9-73
Composite CC-A/B	F0h 56h	Disable	9-73
Composite TLC-39	F0h 73h	Disable	9-74
UPC Composite Mode	F0h 58h	Never Linked	9-74
Composite Beep Mode	F0h 8Eh	Beep As Each Code Type is Decoded	9-75
GS1-128 Emulation Mode for UCC/EAN Composite Codes	F0h ABh	Disable	9-75
2D Symbolologies			
PDF417	0Fh	Enable	9-76
MicroPDF417	E3h	Disable	9-76
Code 128 Emulation	7Bh	Disable	9-77
Data Matrix	F0h 24h	Enable	9-78
Data Matrix Inverse	F1h 4Ch	Regular	9-78
Maxicode	F0h 26h	Disable	9-79
QR Code	F0h 25h	Enable	9-79
QR Inverse	F1h 4Bh	Regular	9-80
MicroQR	F1h 3Dh	Enable	9-80
Aztec	F1h 3Eh	Enable	9-81
Aztec Inverse	F1h 4Dh	Inverse Autodetect	9-81
Symbology-Specific Security Levels			
Redundancy Level	4Eh	1	9-82
Security Level (UPC/EAN and Code 93)	4Dh	1	9-84
Intercharacter Gap Size	F0h 7Dh	Normal	9-85
Macro PDF			
Flush Macro PDF Buffer			9-86
Abort Macro PDF Entry			9-86

Disable All Code Types

To disable all symbologies, scan the bar code below. This is useful when enabling only a few code types.



Disable All Code Types

UPC/EAN

Enable/Disable UPC-A

Parameter # 01h

To enable or disable UPC-A, scan the appropriate bar code below.

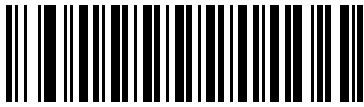

*Enable UPC-A
(01h)

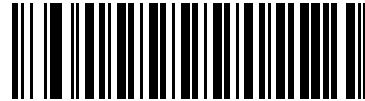

Disable UPC-A
(00h)

Enable/Disable UPC-E

Parameter # 02h

To enable or disable UPC-E, scan the appropriate bar code below.

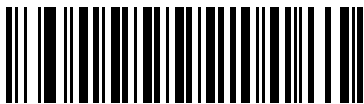

*Enable UPC-E
(01h)



Disable UPC-E
(00h)

Enable/Disable UPC-E1

Parameter # 0Ch

UPC-E1 is disabled by default.

To enable or disable UPC-E1, scan the appropriate bar code below.

✓ **NOTE** UPC-E1 is not a UCC (Uniform Code Council) approved symbology.

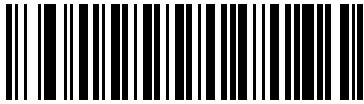

Enable UPC-E1
(01h)



*Disable UPC-E1
(00h)

Enable/Disable EAN-8/JAN-8

Parameter # 04h

To enable or disable EAN-8/JAN-8, scan the appropriate bar code below.



*Enable EAN-8/JAN-8
(01h)



Disable EAN-8/JAN-8
(00h)

Enable/Disable EAN-13/JAN-13

Parameter # 03h

To enable or disable EAN-13/JAN-13, scan the appropriate bar code below.

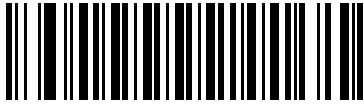

*Enable EAN-13/JAN-13
(01h)

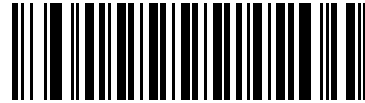

Disable EAN-13/JAN-13
(00h)

Enable/Disable Bookland EAN

Parameter # 53h

To enable or disable Bookland EAN, scan the appropriate bar code below.

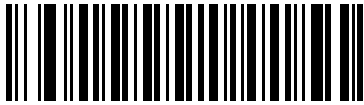

*Enable Bookland EAN
(01h)



Disable Bookland EAN
(00h)



NOTE If Bookland EAN is enabled, select a [Bookland ISBN Format on page 9-11](#). Also select either Decode UPC/EAN Supplementals, Autodiscriminate UPC/EAN Supplementals, or Enable 978/979 Supplemental Mode in [Decode UPC/EAN/JAN Supplementals on page 9-12](#).

Bookland ISBN Format

Parameter # F1h 40h

If Bookland EAN is enabled, select one of the following formats for Bookland data:

- **Bookland ISBN-10** - The digital scanner reports Bookland data starting with 978 in traditional 10-digit format with the special Bookland check digit for backward-compatibility. Data starting with 979 is not considered Bookland in this mode.
- **Bookland ISBN-13** - The digital scanner reports Bookland data (starting with either 978 or 979) as EAN-13 in 13-digit format to meet the 2007 ISBN-13 protocol.



*Bookland ISBN-10
(00h)



Bookland ISBN-13
(01h)



NOTE For Bookland EAN to function properly, ensure Bookland EAN is enabled (see [Enable/Disable Bookland EAN on page 9-10](#)), then select either Decode UPC/EAN Supplementals, Autodiscriminate UPC/EAN Supplementals, or Enable 978/979 Supplemental Mode in [Decode UPC/EAN/JAN Supplementals on page 9-12](#).

Decode UPC/EAN/JAN Supplementals

Parameter # 10h

Supplementals are bar codes appended according to specific format conventions (e.g., UPC A+2, UPC E+2, EAN 13+2). The following options are available:

- If you select **Ignore UPC/EAN with Supplementals**, and the digital scanner is presented with a UPC/EAN plus supplemental symbol, the scanner decodes UPC/EAN and ignores the supplemental characters.
- If you select **Decode UPC/EAN with Supplementals**, the digital scanner only decodes UPC/EAN symbols with supplemental characters, and ignores symbols without supplementals.
- If you select **Autodiscriminate UPC/EAN Supplementals**, the digital scanner decodes UPC/EAN symbols with supplemental characters immediately. If the symbol does not have a supplemental, the digital scanner must decode the bar code the number of times set via [UPC/EAN/JAN Supplemental Redundancy on page 9-15](#) before transmitting its data to confirm that there is no supplemental.
- If you select one of the following **Supplemental Mode** options, the digital scanner immediately transmits EAN-13 bar codes starting with that prefix that have supplemental characters. If the symbol does not have a supplemental, the digital scanner must decode the bar code the number of times set via [UPC/EAN/JAN Supplemental Redundancy on page 9-15](#) before transmitting its data to confirm that there is no supplemental. The digital scanner transmits UPC/EAN bar codes that do not have that prefix immediately.
 - **Enable 378/379 Supplemental Mode**
 - **Enable 978/979 Supplemental Mode**

✓ **NOTE** If you select 978/979 Supplemental Mode and are scanning Bookland EAN bar codes, see [Enable/Disable Bookland EAN on page 9-10](#) to enable Bookland EAN, and select a format using [Bookland ISBN Format on page 9-11](#).

- **Enable 977 Supplemental Mode**
- **Enable 414/419/434/439 Supplemental Mode**
- **Enable 491 Supplemental Mode**
- **Enable Smart Supplemental Mode** - applies to EAN-13 bar codes starting with any prefix listed previously.
- **Supplemental User-Programmable Type 1** - applies to EAN-13 bar codes starting with a 3-digit user-defined prefix. Set this 3-digit prefix using [User-Programmable Supplementals on page 9-15](#).
- **Supplemental User-Programmable Type 1 and 2** - applies to EAN-13 bar codes starting with either of two 3-digit user-defined prefixes. Set the 3-digit prefixes using [User-Programmable Supplementals on page 9-15](#).
- **Smart Supplemental Plus User-Programmable 1** - applies to EAN-13 bar codes starting with any prefix listed previously or the user-defined prefix set using [User-Programmable Supplementals on page 9-15](#).
- **Smart Supplemental Plus User-Programmable 1 and 2** - applies to EAN-13 bar codes starting with any prefix listed previously or one of the two user-defined prefixes set using [User-Programmable Supplementals on page 9-15](#).

✓ **NOTE** To minimize the risk of invalid data transmission, select either to decode or ignore supplemental characters.

Decode UPC/EAN/JAN Supplementals (continued)



Decode UPC/EAN/JAN Only With Supplementals
(01h)

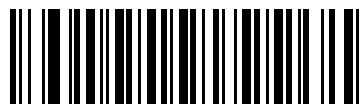

*Ignore Supplementals
(00h)



Autodiscriminate UPC/EAN/JAN Supplementals
(02h)



Enable 378/379 Supplemental Mode
(04h)



Enable 978/979 Supplemental Mode
(05h)



Enable 977 Supplemental Mode
(07h)

Decode UPC/EAN/JAN Supplementals (continued)



Enable 414/419/434/439 Supplemental Mode
(06h)



Enable 491 Supplemental Mode
(08h)



Enable Smart Supplemental Mode
(03h)



Supplemental User-Programmable Type 1
(09h)



Supplemental User-Programmable Type 1 and 2
(0Ah)



Smart Supplemental Plus User-Programmable 1
(0Bh)



Smart Supplemental Plus User-Programmable 1 and 2
(0Ch)

User-Programmable Supplementals

Supplemental 1: Parameter # F1h 43h

Supplemental 2: Parameter # F1h 44h

If you selected a Supplemental User-Programmable option from [Decode UPC/EAN/JAN Supplementals on page 9-12](#), select **User-Programmable Supplemental 1** to set the 3-digit prefix. Then select the 3 digits using the numeric bar codes beginning on [page D-1](#). Select **User-Programmable Supplemental 2** to set a second 3-digit prefix. Then select the 3 digits using the numeric bar codes beginning on [page D-1](#).



User-Programmable Supplemental 1



User-Programmable Supplemental 2

UPC/EAN/JAN Supplemental Redundancy

Parameter # 50h

If you selected **Autodiscriminate UPC/EAN/JAN Supplementals**, this option adjusts the number of times to decode a symbol without supplementals before transmission. The range is from two to thirty times. Five or above is recommended when decoding a mix of UPC/EAN/JAN symbols with and without supplementals. The default is 10.

Scan the bar code below to set a decode redundancy value. Next, scan two numeric bar codes in [Appendix D, Numeric Bar Codes](#). Enter a leading zero for single digit numbers. To correct an error or change a selection, scan [Cancel on page D-2](#).



UPC/EAN/JAN Supplemental Redundancy

UPC/EAN/JAN Supplemental AIM ID Format

Parameter # F1h A0h

Select an output format when reporting UPC/EAN/JAN bar codes with Supplementals with *Transmit Code ID Character* on page 4-32 set to **AIM Code ID Character**:

- **Separate** - transmit UPC/EAN with supplementals with separate AIM IDs but one transmission, i.e.:
]E<0 or 4><data>]E<1 or 2>[supplemental data]
- **Combined** – transmit UPC/EAN with supplementals with one AIM ID and one transmission, i.e.:
]E3<data+supplemental data>
- **Separate Transmissions** - transmit UPC/EAN with supplementals with separate AIM IDs and separate transmissions, i.e.:
]E<0 or 4><data>
]E<1 or 2>[supplemental data]

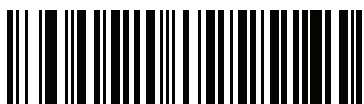

Separate
(00h)



***Combined**
(01h)



Separate Transmissions
(02h)

Transmit UPC-A Check Digit

Parameter # 28h

The check digit is the last character of the symbol used to verify the integrity of the data. Scan the appropriate bar code below to transmit the bar code data with or without the UPC-A check digit. It is always verified to guarantee the integrity of the data.

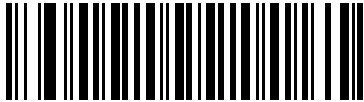

***Transmit UPC-A Check Digit
(01h)**

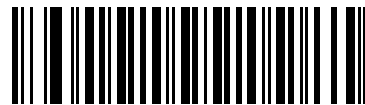

**Do Not Transmit UPC-A Check Digit
(00h)**

Transmit UPC-E Check Digit

Parameter # 29h

The check digit is the last character of the symbol used to verify the integrity of the data. Scan the appropriate bar code below to transmit the bar code data with or without the UPC-E check digit. It is always verified to guarantee the integrity of the data.

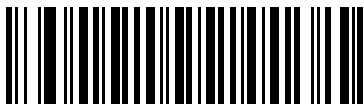

***Transmit UPC-E Check Digit
(01h)**

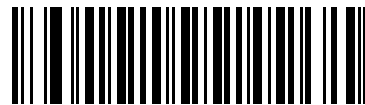

**Do Not Transmit UPC-E Check Digit
(00h)**

Transmit UPC-E1 Check Digit

Parameter # 2Ah

The check digit is the last character of the symbol used to verify the integrity of the data. Scan the appropriate bar code below to transmit the bar code data with or without the UPC-E1 check digit. It is always verified to guarantee the integrity of the data.

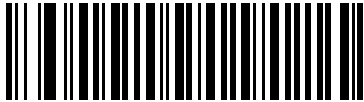

*Transmit UPC-E1 Check Digit
(01h)

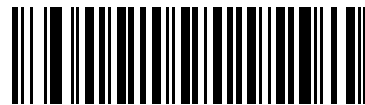

Do Not Transmit UPC-E1 Check Digit
(00h)

UPC-A Preamble

Parameter # 22h

Preamble characters are part of the UPC symbol, and include Country Code and System Character. There are three options for transmitting a UPC-A preamble to the host device: transmit System Character only, transmit System Character and Country Code ("0" for USA), and transmit no preamble. Select the appropriate option to match the host system.

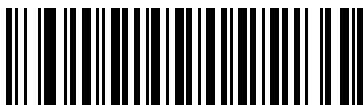

No Preamble (<DATA>)
(00h)

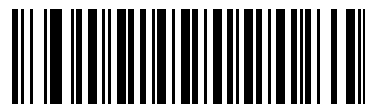

*System Character (<SYSTEM CHARACTER> <DATA>)
(01h)

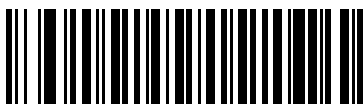

System Character & Country Code
(< COUNTRY CODE> <SYSTEM CHARACTER> <DATA>)
(02h)

UPC-E Preamble

Parameter # 23h

Preamble characters are part of the UPC symbol, and include Country Code and System Character. There are three options for transmitting a UPC-E preamble to the host device: transmit System Character only, transmit System Character and Country Code ("0" for USA), and transmit no preamble. Select the appropriate option to match the host system.



No Preamble (<DATA>)
(00h)



*System Character (<SYSTEM CHARACTER> <DATA>)
(01h)



System Character & Country Code
(< COUNTRY CODE> <SYSTEM CHARACTER> <DATA>)
(02h)

UPC-E1 Preamble

Parameter # 24h

Preamble characters are part of the UPC symbol, and include Country Code and System Character. There are three options for transmitting a UPC-E1 preamble to the host device: transmit System Character only, transmit System Character and Country Code ("0" for USA), and transmit no preamble. Select the appropriate option to match the host system.



No Preamble (<DATA>)
(00h)



*System Character (<SYSTEM CHARACTER> <DATA>)
(01h)

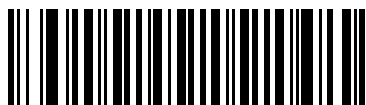

System Character & Country Code
(< COUNTRY CODE> <SYSTEM CHARACTER> <DATA>)
(02h)

Convert UPC-E to UPC-A

Parameter # 25h

Enable this to convert UPC-E (zero suppressed) decoded data to UPC-A format before transmission. After conversion, the data follows UPC-A format and is affected by UPC-A programming selections (e.g., Preamble, Check Digit).

Disable this to transmit UPC-E decoded data as UPC-E data, without conversion.

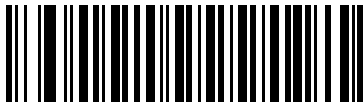

Convert UPC-E to UPC-A (Enable)
(01h)

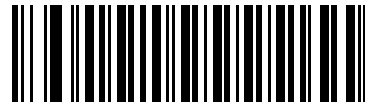

*Do Not Convert UPC-E to UPC-A (Disable)
(00h)

Convert UPC-E1 to UPC-A

Parameter # 26h

Enable this to convert UPC-E1 decoded data to UPC-A format before transmission. After conversion, the data follows UPC-A format and is affected by UPC-A programming selections (e.g., Preamble, Check Digit).

Disable this to transmit UPC-E1 decoded data as UPC-E1 data, without conversion.

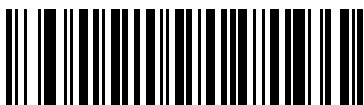

Convert UPC-E1 to UPC-A (Enable)
(01h)

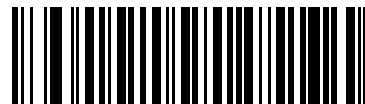

*Do Not Convert UPC-E1 to UPC-A (Disable)
(00h)

EAN-8/JAN-8 Extend

Parameter # 27h

Enable this parameter to add five leading zeros to decoded EAN-8 symbols to make them compatible in format to EAN-13 symbols.

Disable this to transmit EAN-8 symbols as is.

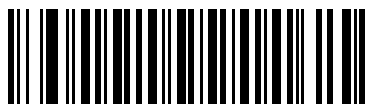

Enable EAN/JAN Zero Extend
(01h)

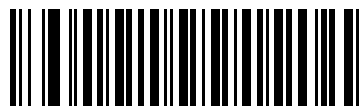

*Disable EAN/JAN Zero Extend
(00h)

UCC Coupon Extended Code

Parameter # 55h

Enable this parameter to decode UPC-A bar codes starting with digit '5', EAN-13 bar codes starting with digit '99', and UPC-A/GS1-128 Coupon Codes. UPCA, EAN-13, and GS1-128 must be enabled to scan all types of Coupon Codes.

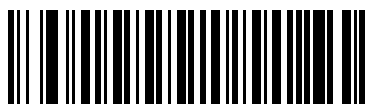

Enable UCC Coupon Extended Code
(01h)



*Disable UCC Coupon Extended Code
(00h)



NOTE See [UPC/EAN/JAN Supplemental Redundancy on page 9-15](#) to control autodiscrimination of the GS1-128 (right half) of a coupon code.

Coupon Report

Parameter # F1h DAh

Traditional coupon symbols (old coupon symbols) are composed of two bar codes: UPC/EAN and Code128. A new coupon symbol is composed of a single Databar Expanded bar code. The new coupon format offers more options for purchase values (up to \$999.99) and supports complex discount offers such as a second purchase requirement.

An interim coupon symbol also exists that contains both types of bar codes: UPC/EAN and Databar Expanded. This format accommodates both retailers that do not recognize or use the additional information included in the new coupon symbol, as well as those who can process new coupon symbols.

Scan a bar code below to select one of the following options for decoding coupon symbols:

- **Old Coupon Symbols** - Scanning an old coupon symbol reports both UPC and Code 128, scanning an interim coupon symbol reports UPC, and scanning a new coupon symbol reports nothing (no decode).
- **New Coupon Symbols** - Scanning an old coupon symbol reports either UPC or Code 128, and scanning an interim coupon symbol or a new coupon symbol reports Databar Expanded.
- **Both Coupon Formats** - Scanning an old coupon symbol reports both UPC and Code 128, and scanning an interim coupon symbol or a new coupon symbol reports Databar Expanded.



**Old Coupon Symbols
(00h)**



***New Coupon Symbols
(01h)**



**Both Coupon Formats
(02h)**

ISSN EAN

Parameter # F1h 69h

To enable or disable ISSN EAN, scan the appropriate bar code below.



*Enable ISSN EAN
(01h)

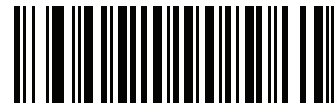

Disable ISSN EAN
(00h)

Code 128

Enable/Disable Code 128

Parameter # 08h

To enable or disable Code 128, scan the appropriate bar code below.

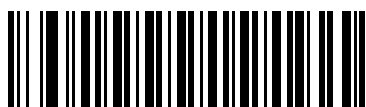

*Enable Code 128
(01h)



Disable Code 128
(00h)

Set Lengths for Code 128

Parameter # L1 = D1h, L2 = D2h

The length of a code refers to the number of characters (i.e., human readable characters), including check digit(s) the code contains. Set lengths for Code 128 to any length, one or two discrete lengths, or lengths within a specific range.

✓ **NOTE** When setting lengths for different bar code types, enter a leading zero for single digit numbers.

- **One Discrete Length** - Select this option to decode only Code 128 symbols containing a selected length. Select the length using the numeric bar codes in [Appendix D, Numeric Bar Codes](#). For example, to decode only Code 128 symbols with 14 characters, scan **Code 128 - One Discrete Length**, then scan **1** followed by **4**. To correct an error or change the selection, scan [Cancel on page D-2](#).
- **Two Discrete Lengths** - Select this option to decode only Code 128 symbols containing either of two selected lengths. Select lengths using the numeric bar codes in [Appendix D, Numeric Bar Codes](#). For example, to decode only Code 128 symbols containing either 2 or 14 characters, select **Code 128 - Two Discrete Lengths**, then scan **0, 2, 1**, and then **4**. To correct an error or change the selection, scan [Cancel on page D-2](#).
- **Length Within Range** - Select this option to decode a Code 128 symbol with a specific length range. Select lengths using numeric bar codes in [Appendix D, Numeric Bar Codes](#). For example, to decode Code 128 symbols containing between 4 and 12 characters, first scan **Code 128 - Length Within Range**. Then scan **0, 4, 1**, and **2** (enter a leading zero for single digit numbers). To correct an error or change the selection, scan [Cancel on page D-2](#).
- **Any Length** - Select this option to decode Code 128 symbols containing any number of characters within the digital scanner's capability.

Set Lengths for Code 128 (continued)

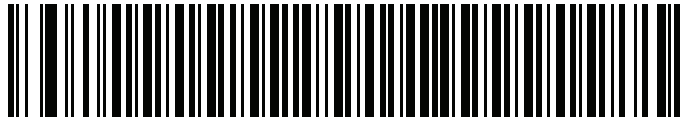

Code 128 - One Discrete Length

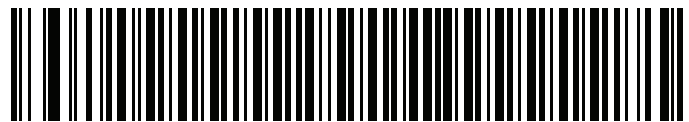

Code 128 - Two Discrete Lengths

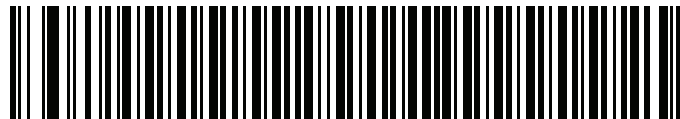

Code 128 - Length Within Range

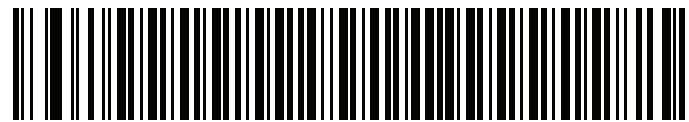

*Code 128 - Any Length

Enable/Disable GS1-128 (formerly UCC/EAN-128)

Parameter # 0Eh

To enable or disable GS1-128, scan the appropriate bar code below.



*Enable GS1-128
(01h)

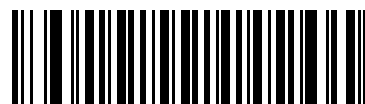

Disable GS1-128
(00h)

Enable/Disable ISBT 128

Parameter # 54h

ISBT 128 is a variant of Code 128 used in the blood bank industry. Scan a bar code below to enable or disable ISBT 128. If necessary, the host must perform concatenation of the ISBT data.



***Enable ISBT 128
(01h)**



**Disable ISBT 128
(00h)**

ISBT Concatenation

Parameter # F1h 41h

Select an option for concatenating pairs of ISBT code types:

- If you select **Disable ISBT Concatenation**, the digital scanner does not concatenate pairs of ISBT codes it encounters.
- If you select **Enable ISBT Concatenation**, there must be two ISBT codes in order for the digital scanner to decode and perform concatenation. The digital scanner does not decode single ISBT symbols.
- If you select **Autodiscriminate ISBT Concatenation**, the digital scanner decodes and concatenates pairs of ISBT codes immediately. If only a single ISBT symbol is present, the digital scanner must decode the symbol the number of times set via [ISBT Concatenation Redundancy on page 9-29](#) before transmitting its data to confirm that there is no additional ISBT symbol.



*Disable ISBT Concatenation
(00h)



Enable ISBT Concatenation
(01h)

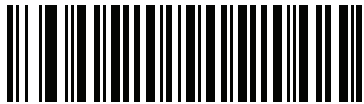

Autodiscriminate ISBT Concatenation
(00h)

Check ISBT Table

Parameter # F1h 42h

The ISBT specification includes a table that lists several types of ISBT bar codes that are commonly used in pairs. If you set **ISBT Concatenation** to **Enable**, enable **Check ISBT Table** to concatenate only those pairs found in this table. Other types of ISBT codes are not concatenated.



*Enable Check ISBT Table
(01h)

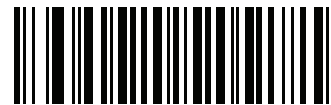

Disable Check ISBT Table
(00h)

ISBT Concatenation Redundancy

Parameter # DFh

If you set **ISBT Concatenation** to **Autodiscriminate**, use this parameter to set the number of times the digital scanner must decode an ISBT symbol before determining that there is no additional symbol.

Scan the bar code below, then scan two numeric bar codes in [Appendix D, Numeric Bar Codes](#) to set a value between 2 and 20. Enter a leading zero for single digit numbers. To correct an error or change a selection, scan [Cancel on page D-2](#). The default is 10.



ISBT Concatenation Redundancy

Code 39

Enable/Disable Code 39

Parameter # 00h

To enable or disable Code 39, scan the appropriate bar code below.



*Enable Code 39
(01h)



Disable Code 39
(00h)

Enable/Disable Trioptic Code 39

Parameter # 0Dh

Trioptic Code 39 is a variant of Code 39 used in the marking of computer tape cartridges. Trioptic Code 39 symbols always contain six characters. To enable or disable Trioptic Code 39, scan the appropriate bar code below.



Enable Trioptic Code 39
(01h)

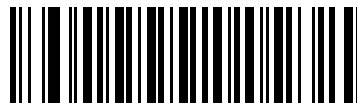

*Disable Trioptic Code 39
(00h)



NOTE You cannot enable Trioptic Code 39 and Code 39 Full ASCII simultaneously.

Convert Code 39 to Code 32

Parameter # 56h

Code 32 is a variant of Code 39 used by the Italian pharmaceutical industry. Scan the appropriate bar code below to enable or disable converting Code 39 to Code 32.

✓ **NOTE** Code 39 must be enabled for this parameter to function.

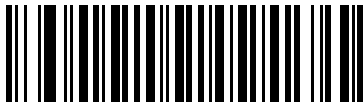

Enable Convert Code 39 to Code 32
(01h)

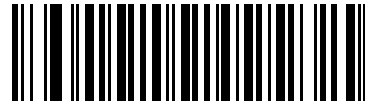

*Disable Convert Code 39 to Code 32
(00h)

Code 32 Prefix

Parameter # E7h

Scan the appropriate bar code below to enable or disable adding the prefix character “A” to all Code 32 bar codes.

✓ **NOTE** Convert Code 39 to Code 32 must be enabled for this parameter to function.

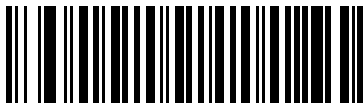

Enable Code 32 Prefix
(01h)

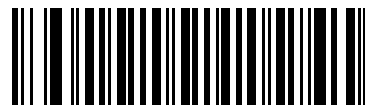

*Disable Code 32 Prefix
(00h)

Set Lengths for Code 39

Parameter # L1 = 12h, L2 = 13h

The length of a code refers to the number of characters (i.e., human readable characters), including check digit(s) the code contains. Set lengths for Code 39 to any length, one or two discrete lengths, or lengths within a specific range. If Code 39 Full ASCII is enabled, **Length Within a Range** or **Any Length** are the preferred options.

✓ **NOTE** When setting lengths for different bar code types, enter a leading zero for single digit numbers.

- **One Discrete Length** - Select this option to decode only Code 39 symbols containing a selected length. Select the length using the numeric bar codes in [Appendix D, Numeric Bar Codes](#). For example, to decode only Code 39 symbols with 14 characters, scan **Code 39 - One Discrete Length**, then scan **1** followed by **4**. To correct an error or change the selection, scan [Cancel on page D-2](#).
- **Two Discrete Lengths** - Select this option to decode only Code 39 symbols containing either of two selected lengths. Select lengths using the numeric bar codes in [Appendix D, Numeric Bar Codes](#). For example, to decode only Code 39 symbols containing either 2 or 14 characters, select **Code 39 - Two Discrete Lengths**, then scan **0, 2, 1**, and then **4**. To correct an error or change the selection, scan [Cancel on page D-2](#).
- **Length Within Range** - Select this option to decode a Code 39 symbol with a specific length range. Select lengths using numeric bar codes in [Appendix D, Numeric Bar Codes](#). For example, to decode Code 39 symbols containing between 4 and 12 characters, first scan **Code 39 - Length Within Range**. Then scan **0, 4, 1**, and **2** (enter a leading zero for single digit numbers). To correct an error or change the selection, scan [Cancel on page D-2](#).
- **Any Length** - Select this option to decode Code 39 symbols containing any number of characters within the digital scanner's capability.



Code 39 - One Discrete Length



Code 39 - Two Discrete Lengths



*Code 39 - Length Within Range



Code 39 - Any Length

Code 39 Check Digit Verification

Parameter # 30h

Enable this feature to check the integrity of all Code 39 symbols to verify that the data complies with specified check digit algorithm. Only Code 39 symbols which include a modulo 43 check digit are decoded. Enable this feature if the Code 39 symbols contain a Modulo 43 check digit.

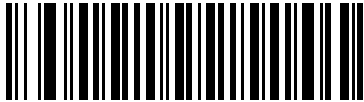

Enable Code 39 Check Digit
(01h)

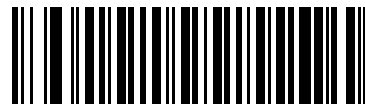

*Disable Code 39 Check Digit
(00h)

Transmit Code 39 Check Digit

Parameter # 2Bh

Scan a bar code below to transmit Code 39 data with or without the check digit.

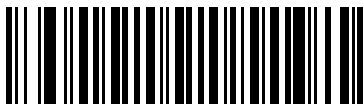

Transmit Code 39 Check Digit (Enable)
(01h)

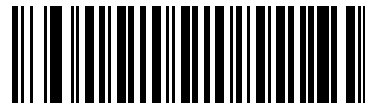

*Do Not Transmit Code 39 Check Digit (Disable)
(00h)



NOTE Code 39 Check Digit Verification must be enabled for this parameter to function.

Code 39 Full ASCII Conversion

Parameter # 11h

Code 39 Full ASCII is a variant of Code 39 which pairs characters to encode the full ASCII character set. To enable or disable Code 39 Full ASCII, scan the appropriate bar code below.



Enable Code 39 Full ASCII
(01h)

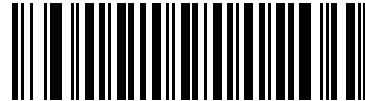

*Disable Code 39 Full ASCII
(00h)



NOTE You cannot enable Trioptic Code 39 and Code 39 Full ASCII simultaneously.

Code 39 Full ASCII to Full ASCII Correlation is host-dependent, and is therefore described in the ASCII Character Set Table for the appropriate interface. See the [ASCII Character Set for USB on page 5-19](#) or the [ASCII Character Set for RS-232 on page 6-19](#).

Code 39 Buffering - Scan & Store

Parameter # 71h

This feature allows the digital scanner to accumulate data from multiple Code 39 symbols.

Selecting the Scan and Store option (Buffer Code 39) temporarily buffers all Code 39 symbols having a leading space as a first character for later transmission. The leading space is not buffered.

Decoding a Code 39 symbol with no leading space transmits in sequence all buffered data in a first-in first-out format, plus the “triggering” symbol. See the following pages for further details.

Select **Do Not Buffer Code 39** to transmit all decoded Code 39 symbols immediately without storing them in the buffer.

This feature affects Code 39 only. If selecting **Buffer Code 39**, we recommend configuring the digital scanner to decode Code 39 symbology only.

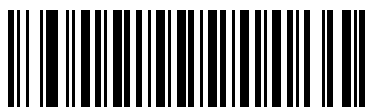

Buffer Code 39 (Enable)
(01h)

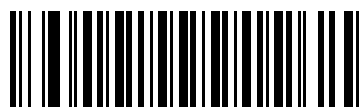

*Do Not Buffer Code 39 (Disable)
(00h)

While there is data in the transmission buffer, you cannot select **Do Not Buffer Code 39**. The buffer holds 200 bytes of information.

To disable Code 39 buffering when there is data in the transmission buffer, first force the buffer transmission (see [Transmit Buffer on page 9-36](#)) or clear the buffer.

Buffer Data

To buffer data, enable Code 39 buffering and scan a Code 39 symbol with a space immediately following the start pattern.

- Unless the data overflows the transmission buffer, the digital scanner issues a low/high beep to indicate successful decode and buffering. (For overflow conditions, see [Overfilling Transmission Buffer on page 9-36](#).)
- The digital scanner adds the decoded data excluding the leading space to the transmission buffer.
- No transmission occurs.

Clear Transmission Buffer

To clear the transmission buffer, scan the **Clear Buffer** bar code below, which contains only a start character, a dash (minus), and a stop character.

- The digital scanner issues a short high/low/high beep.
- The digital scanner erases the transmission buffer.
- No transmission occurs.

**Clear Buffer**

- ✓ **NOTE** The Clear Buffer contains only the dash (minus) character. In order to scan this command, set Code 39 lengths to include length 1.

Transmit Buffer

There are two methods to transmit the Code 39 buffer.

1. Scan the **Transmit Buffer** bar code below, which includes only a start character, a plus (+), and a stop character.
2. The digital scanner transmits and clears the buffer.
 - The digital scanner issues a low/high beep.

**Transmit Buffer**

3. Scan a Code 39 bar code with a leading character other than a space.
 - The digital scanner appends new decode data to buffered data.
 - The digital scanner transmits and clears the buffer.
 - The digital scanner signals that it transmitted the buffer with a low/high beep.
 - The digital scanner transmits and clears the buffer.

- ✓ **NOTE** The Transmit Buffer contains only a plus (+) character. In order to scan this command, set Code 39 lengths to include length 1.

Overfilling Transmission Buffer

The Code 39 buffer holds 200 characters. If the symbol just read overflows the transmission buffer:

- The digital scanner indicates that it rejected the symbol by issuing three long, high beeps.
- No transmission occurs. The data in the buffer is not affected.

Attempt to Transmit an Empty Buffer

If you scan the **Transmit Buffer** symbol and the Code 39 buffer is empty:

- A short low/high/low beep signals that the buffer is empty.
- No transmission occurs.
- The buffer remains empty.

Code 93

Enable/Disable Code 93

Parameter # 09h

To enable or disable Code 93, scan the appropriate bar code below.

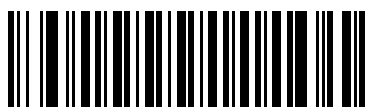

Enable Code 93
(01h)



*Disable Code 93
(00h)

Set Lengths for Code 93

Parameter # L1 = 1Ah, L2 = 1Bh

The length of a code refers to the number of characters (i.e., human readable characters), including check digit(s) the code contains. Set lengths for Code 93 to any length, one or two discrete lengths, or lengths within a specific range.

- **One Discrete Length** - Select this option to decode only Code 93 symbols containing a selected length. Select the length using the numeric bar codes in [Appendix D, Numeric Bar Codes](#). For example, to decode only Code 93 symbols with 14 characters, scan **Code 93 - One Discrete Length**, then scan **1** followed by **4**. To correct an error or to change the selection, scan [Cancel on page D-2](#).
- **Two Discrete Lengths** - Select this option to decode only Code 93 symbols containing either of two selected lengths. Select lengths using the numeric bar codes in [Appendix D, Numeric Bar Codes](#). For example, to decode only Code 93 symbols containing either 2 or 14 characters, select **Code 93 - Two Discrete Lengths**, then scan **0**, **2**, **1**, and then **4**. To correct an error or to change the selection, scan [Cancel on page D-2](#).
- **Length Within Range** - Select this option to decode a Code 93 symbol with a specific length range. Select lengths using the numeric bar codes in [Appendix D, Numeric Bar Codes](#). For example, to decode Code 93 symbols containing between 4 and 12 characters, first scan **Code 93 - Length Within Range**. Then scan **0**, **4**, **1**, and **2** (enter a leading zero for single digit numbers). To correct an error or change the selection, scan [Cancel on page D-2](#).
- **Any Length** - Scan this option to decode Code 93 symbols containing any number of characters within the digital scanner's capability.

Set Lengths for Code 93 (continued)



Code 93 - One Discrete Length



Code 93 - Two Discrete Lengths



*Code 93 - Length Within Range



Code 93 - Any Length

Code 11

Code 11

Parameter # 0Ah

To enable or disable Code 11, scan the appropriate bar code below.



Enable Code 11
(01h)



*Disable Code 11
(00h)

Set Lengths for Code 11

Parameter # L1 = 1Ch, L2 = 1Dh

The length of a code refers to the number of characters (i.e., human readable characters), including check digit(s) the code contains. Set lengths for Code 11 to any length, one or two discrete lengths, or lengths within a specific range.

- One Discrete Length** - Select this option to decode only Code 11 symbols containing a selected length. Select the length using the numeric bar codes in [Appendix D, Numeric Bar Codes](#). For example, to decode only Code 11 symbols with 14 characters, scan **Code 11 - One Discrete Length**, then scan **1** followed by **4**. To correct an error or to change the selection, scan [Cancel on page D-2](#).
- Two Discrete Lengths** - Select this option to decode only Code 11 symbols containing either of two selected lengths. Select lengths using the numeric bar codes in [Appendix D, Numeric Bar Codes](#). For example, to decode only Code 11 symbols containing either 2 or 14 characters, select **Code 11 - Two Discrete Lengths**, then scan **0**, **2**, **1**, and then **4**. To correct an error or to change the selection, scan [Cancel on page D-2](#).
- Length Within Range** - Select this option to decode a Code 11 symbol with a specific length range. Select lengths using numeric bar codes in [Appendix D, Numeric Bar Codes](#). For example, to decode Code 11 symbols containing between 4 and 12 characters, first scan **Code 11 - Length Within Range**. Then scan **0**, **4**, **1**, and **2** (enter a leading zero for single digit numbers). To correct an error or change the selection, scan [Cancel on page D-2](#).
- Any Length** - Scan this option to decode Code 11 symbols containing any number of characters within the digital scanner's capability.

Set Lengths for Code 11 (continued)



Code 11 - One Discrete Length



Code 11 - Two Discrete Lengths



*Code 11 - Length Within Range



Code 11 - Any Length

Code 11 Check Digit Verification

Parameter # 34h

This feature allows the digital scanner to check the integrity of all Code 11 symbols to verify that the data complies with the specified check digit algorithm. This selects the check digit mechanism for the decoded Code 11 bar code. The options are to check for one check digit, check for two check digits, or disable the feature.

To enable this feature, scan the bar code below corresponding to the number of check digits encoded in the Code 11 symbols.

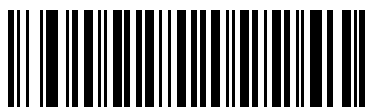

***Disable
(00h)**



**One Check Digit
(01h)**

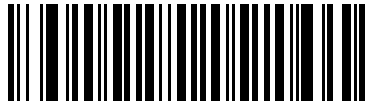

**Two Check Digits
(02h)**

Transmit Code 11 Check Digits

Parameter # 2Fh

This feature selects whether or not to transmit the Code 11 check digit(s).



Transmit Code 11 Check Digit(s) (Enable)
(01h)

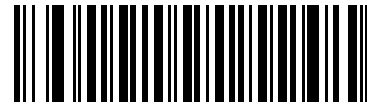

*Do Not Transmit Code 11 Check Digit(s) (Disable)
(00h)



NOTE Code 11 Check Digit Verification must be enabled for this parameter to function.

Interleaved 2 of 5 (ITF)

Enable/Disable Interleaved 2 of 5

Parameter # 06h

To enable or disable Interleaved 2 of 5, scan the appropriate bar code below, and select an Interleaved 2 of 5 length from the following pages.

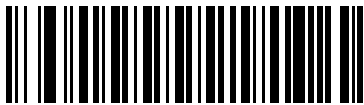

Enable Interleaved 2 of 5
(01h)



*Disable Interleaved 2 of 5
(00h)

Set Lengths for Interleaved 2 of 5

Parameter # L1 = 16h, L2 = 17h

The length of a code refers to the number of characters (i.e., human readable characters), including check digit(s) the code contains. Set lengths for I 2 of 5 to any length, one or two discrete lengths, or lengths within a specific range. The range for Interleaved 2 of 5 lengths is 0 - 55.

- **One Discrete Length** - Select this option to decode only I 2 of 5 symbols containing a selected length. Select the length using the numeric bar codes in [Appendix D, Numeric Bar Codes](#). For example, to decode only I 2 of 5 symbols with 14 characters, scan **I 2 of 5 - One Discrete Length**, then scan **1** followed by **4**. To correct an error or to change the selection, scan [Cancel on page D-2](#).
- **Two Discrete Lengths** - Select this option to decode only I 2 of 5 symbols containing either of two selected lengths. Select lengths using the numeric bar codes in [Appendix D, Numeric Bar Codes](#). For example, to decode only I 2 of 5 symbols containing either 2 or 14 characters, select **I 2 of 5 - Two Discrete Lengths**, then scan **0, 2, 1**, and then **4**. To correct an error or to change the selection, scan [Cancel on page D-2](#).
- **Length Within Range** - Select this option to decode an I 2 of 5 symbol with a specific length range. Select lengths using numeric bar codes in [Appendix D, Numeric Bar Codes](#). For example, to decode I 2 of 5 symbols containing between 4 and 12 characters, first scan **I 2 of 5 - Length Within Range**. Then scan **0, 4, 1**, and **2** (enter a leading zero for single digit numbers). To correct an error or change the selection, scan [Cancel on page D-2](#).
- **Any Length** - Scan this option to decode I 2 of 5 symbols containing any number of characters within the digital scanner's capability.

✓ **NOTE** Due to the construction of the I 2 of 5 symbology, it is possible for a scan line covering only a portion of the code to transmit as a complete scan, yielding less data than is encoded in the bar code. To prevent this, select specific lengths (I 2 of 5 - One Discrete Length, Two Discrete Lengths) for I 2 of 5 applications.

Set Lengths for Interleaved 2 of 5 (continued)



*I 2 of 5 - One Discrete Length



I 2 of 5 - Two Discrete Lengths



I 2 of 5 - Length Within Range



I 2 of 5 - Any Length

I 2 of 5 Check Digit Verification

Parameter # 31h

Enable this feature to check the integrity of all I 2 of 5 symbols to verify the data complies with either the specified Uniform Symbology Specification (USS), or the Optical Product Code Council (OPCC) check digit algorithm.



*Disable
(00h)



USS Check Digit
(01h)



OPCC Check Digit
(02h)

Transmit I 2 of 5 Check Digit

Parameter # 2Ch

Scan the appropriate bar code below to transmit I 2 of 5 data with or without the check digit.

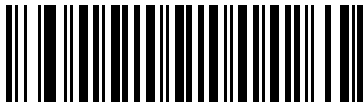

Transmit I 2 of 5 Check Digit (Enable)
(01h)



*Do Not Transmit I 2 of 5 Check Digit (Disable)
(00h)

Convert I 2 of 5 to EAN-13

Parameter # 52h

Enable this parameter to convert 14-character I 2 of 5 codes to EAN-13, and transmit to the host as EAN-13. To accomplish this, the I 2 of 5 code must be enabled, and the code must have a leading zero and a valid EAN-13 check digit.

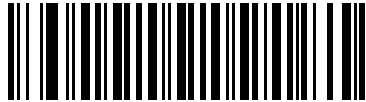

Convert I 2 of 5 to EAN-13 (Enable)
(01h)

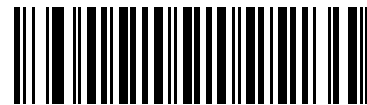

*Do Not Convert I 2 of 5 to EAN-13 (Disable)
(00h)

Discrete 2 of 5 (DTF)

Enable/Disable Discrete 2 of 5

Parameter # 05h

To enable or disable Discrete 2 of 5, scan the appropriate bar code below.

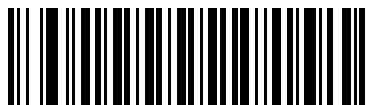

Enable Discrete 2 of 5
(01h)

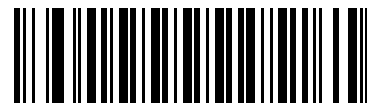

*Disable Discrete 2 of 5
(00h)

Set Lengths for Discrete 2 of 5

Parameter # L1 = 14h, L2 = 15h

The length of a code refers to the number of characters (i.e., human readable characters), including check digit(s) the code contains. Set lengths for D 2 of 5 to any length, one or two discrete lengths, or lengths within a specific range. The range for Discrete 2 of 5 lengths is 0 - 55.

- **One Discrete Length** - Select this option to decode only D 2 of 5 symbols containing a selected length. Select the length using the numeric bar codes in [Appendix D, Numeric Bar Codes](#). For example, to decode only D 2 of 5 symbols with 14 characters, scan **D 2 of 5 - One Discrete Length**, then scan **1** followed by **4**. To correct an error or to change the selection, scan [Cancel on page D-2](#).
 - **Two Discrete Lengths** - Select this option to decode only D 2 of 5 symbols containing either of two selected lengths. Select lengths using the numeric bar codes in [Appendix D, Numeric Bar Codes](#). For example, to decode only D 2 of 5 symbols containing either 2 or 14 characters, select **D 2 of 5 - Two Discrete Lengths**, then scan **0, 2, 1**, and then **4**. To correct an error or to change the selection, scan [Cancel on page D-2](#).
 - **Length Within Range** - Select this option to decode a D 2 of 5 symbol with a specific length range. Select lengths using numeric bar codes in [Appendix D, Numeric Bar Codes](#). For example, to decode D 2 of 5 symbols containing between 4 and 12 characters, first scan **D 2 of 5 - Length Within Range**. Then scan **0, 4, 1**, and **2** (enter a leading zero for single digit numbers). To correct an error or change the selection, scan [Cancel on page D-2](#).
 - **Any Length** - Scan this option to decode D 2 of 5 symbols containing any number of characters within the digital scanner's capability.
- ✓ **NOTE** Due to the construction of the D 2 of 5 symbology, it is possible for a scan line covering only a portion of the code to transmit as a complete scan, yielding less data than is encoded in the bar code. To prevent this, select specific lengths (**D 2 of 5 - One Discrete Length, Two Discrete Lengths**) for D 2 of 5 applications.

Set Lengths for Discrete 2 of 5 (continued)



***D 2 of 5 - One Discrete Length**



D 2 of 5 - Two Discrete Lengths



D 2 of 5 - Length Within Range



D 2 of 5 - Any Length

Codabar (NW - 7)

Enable/Disable Codabar

Parameter # 07h

To enable or disable Codabar, scan the appropriate bar code below.



Enable Codabar
(01h)



*Disable Codabar
(00h)

Set Lengths for Codabar

Parameter # L1 = 18h, L2 = 19h

The length of a code refers to the number of characters (i.e., human readable characters), including check digit(s) the code contains. Set lengths for Codabar to any length, one or two discrete lengths, or lengths within a specific range.

- **One Discrete Length** - Select this option to decode only Codabar symbols containing a selected length. Select the length using the numeric bar codes in [Appendix D, Numeric Bar Codes](#). For example, to decode only Codabar symbols with 14 characters, scan **Codabar - One Discrete Length**, then scan **1** followed by **4**. To correct an error or to change the selection, scan [Cancel on page D-2](#).
- **Two Discrete Lengths** - Select this option to decode only Codabar symbols containing either of two selected lengths. Select lengths using the numeric bar codes in [Appendix D, Numeric Bar Codes](#). For example, to decode only Codabar symbols containing either 2 or 14 characters, select **Codabar - Two Discrete Lengths**, then scan **0**, **2**, **1**, and then **4**. To correct an error or to change the selection, scan [Cancel on page D-2](#).
- **Length Within Range** - Select this option to decode a Codabar symbol with a specific length range. Select lengths using numeric bar codes in [Appendix D, Numeric Bar Codes](#). For example, to decode Codabar symbols containing between 4 and 12 characters, first scan **Codabar - Length Within Range**. Then scan **0**, **4**, **1**, and **2** (enter a leading zero for single digit numbers). To correct an error or change the selection, scan [Cancel on page D-2](#).
- **Any Length** - Scan this option to decode Codabar symbols containing any number of characters within the digital scanner's capability.

Set Lengths for Codabar (continued)



Codabar - One Discrete Length



Codabar - Two Discrete Lengths



*Codabar - Length Within Range



Codabar - Any Length

CLSI Editing

Parameter # 36h

Enable this parameter to strip the start and stop characters and insert a space after the first, fifth, and tenth characters of a 14-character Codabar symbol. Enable this feature if the host system requires this data format.

✓ **NOTE** Symbol length does not include start and stop characters.

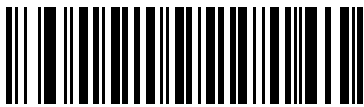

Enable CLSI Editing
(01h)

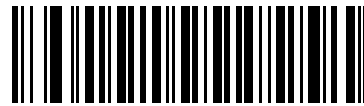

*Disable CLSI Editing
(00h)

NOTIS Editing

Parameter # 37h

Enable this parameter to strip the start and stop characters from a decoded Codabar symbol. Enable this feature if the host system requires this data format.

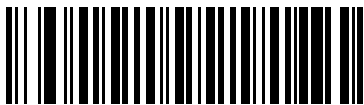

Enable NOTIS Editing
(01h)

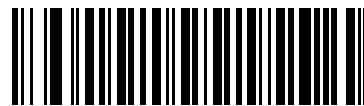

*Disable NOTIS Editing
(00h)

MSI

Enable/Disable MSI

Parameter # 0Bh

To enable or disable MSI, scan the appropriate bar code below.

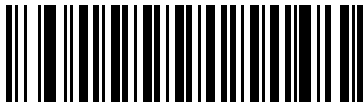

Enable MSI
(01h)

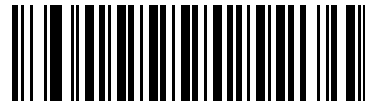

*Disable MSI
(00h)

Set Lengths for MSI

Parameter # L1 = 1Eh, L2 = 1Fh

The length of a code refers to the number of characters (i.e., human readable characters), including check digit(s) the code contains. Set lengths for MSI to any length, one or two discrete lengths, or lengths within a specific range.

- **One Discrete Length** - Select this option to decode only MSI symbols containing a selected length. Select the length using the numeric bar codes in [Appendix D, Numeric Bar Codes](#). For example, to decode only MSI symbols with 14 characters, scan **MSI - One Discrete Length**, then scan **1** followed by **4**. To correct an error or to change the selection, scan [Cancel on page D-2](#).
- **Two Discrete Lengths** - Select this option to decode only MSI symbols containing either of two selected lengths. Select lengths using the numeric bar codes in [Appendix D, Numeric Bar Codes](#). For example, to decode only MSI symbols containing either 2 or 14 characters, select **MSI - Two Discrete Lengths**, then scan **0**, **2**, **1**, and then **4**. To correct an error or to change the selection, scan [Cancel on page D-2](#).
- **Length Within Range** - Select this option to decode a MSI symbol with a specific length range. Select lengths using numeric bar codes in [Appendix D, Numeric Bar Codes](#). For example, to decode MSI symbols containing between 4 and 12 characters, first scan **MSI - Length Within Range**. Then scan **0**, **4**, **1**, and **2** (enter a leading zero for single digit numbers). To correct an error or change the selection, scan [Cancel on page D-2](#).
- **Any Length** - Scan this option to decode MSI symbols containing any number of characters within the digital scanner's capability.

Set Lengths for MSI (continued)

- ✓ **NOTE** Due to the construction of the MSI symbology, it is possible for a scan line covering only a portion of the code to transmit as a complete scan, yielding less data than is encoded in the bar code. To prevent this, select specific lengths (**MSI - One Discrete Length**, **Two Discrete Lengths**) for MSI applications.



MSI - One Discrete Length



MSI - Two Discrete Lengths



***MSI - Length Within Range**



MSI - Any Length

MSI Check Digits

Parameter # 32h

With MSI symbols, one check digit is mandatory and always verified by the reader. The second check digit is optional. If the MSI codes include two check digits, scan the **Two MSI Check Digits** bar code to enable verification of the second check digit.

See [MSI Check Digit Algorithm on page 9-55](#) for the selection of second digit algorithms.

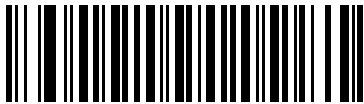

* One MSI Check Digit
(00h)

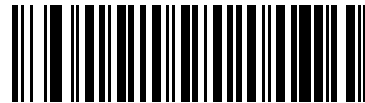

Two MSI Check Digits
(01h)

Transmit MSI Check Digit(s)

Parameter # 2Eh

Scan a bar code below to transmit MSI data with or without the check digit.

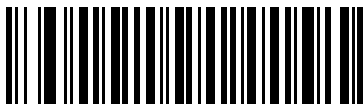

Transmit MSI Check Digit(s) (Enable)
(01h)

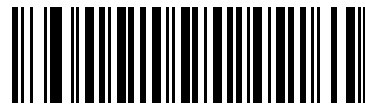

* Do Not Transmit MSI Check Digit(s) (Disable)
(00h)

MSI Check Digit Algorithm

Parameter # 33h

Two algorithms are possible for the verification of the second MSI check digit. Select the bar code below corresponding to the algorithm used to encode the check digit.

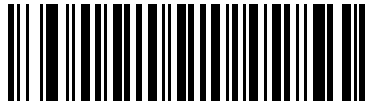

MOD 10/MOD 11
(00h)



*MOD 10/MOD 10
(01h)

Chinese 2 of 5

Enable/Disable Chinese 2 of 5

Parameter # F0h 98h

To enable or disable Chinese 2 of 5, scan the appropriate bar code below.



Enable Chinese 2 of 5
(01h)



*Disable Chinese 2 of 5
(00h)

Matrix 2 of 5

Enable/Disable Matrix 2 of 5

Parameter # F1h 6Ah

To enable or disable Matrix 2 of 5, scan the appropriate bar code below.



Enable Matrix 2 of 5
(01h)



*Disable Matrix 2 of 5
(00h)

Set Lengths for Matrix 2 of 5

Parameter # L1 = F1h 6Bh, L2 = F1h 6Ch

The length of a code refers to the number of characters (i.e., human readable characters), including check digit(s) the code contains. Set lengths for Matrix 2 of 5 to any length, one or two discrete lengths, or lengths within a specific range.

- **One Discrete Length** - Select this option to decode only Matrix 2 of 5 symbols containing a selected length. Select the length using the numeric bar codes in [Appendix D, Numeric Bar Codes](#). For example, to decode only Matrix 2 of 5 symbols with 14 characters, scan **Matrix 2 of 5 - One Discrete Length**, then scan **1** followed by **4**. To correct an error or to change the selection, scan [Cancel on page D-2](#).
- **Two Discrete Lengths** - Select this option to decode only Matrix 2 of 5 symbols containing either of two selected lengths. Select lengths using the numeric bar codes in [Appendix D, Numeric Bar Codes](#). For example, to decode only Matrix 2 of 5 symbols containing either 2 or 14 characters, select **Matrix 2 of 5 - Two Discrete Lengths**, then scan **0, 2, 1**, and then **4**. To correct an error or to change the selection, scan [Cancel on page D-2](#).
- **Length Within Range** - Select this option to decode a Matrix 2 of 5 symbol with a specific length range. Select lengths using the numeric bar codes in [Appendix D, Numeric Bar Codes](#). For example, to decode Matrix 2 of 5 symbols containing between 4 and 12 characters, first scan **Matrix 2 of 5 - Length Within Range**. Then scan **0, 4, 1**, and **2** (enter a leading zero for single digit numbers). To correct an error or change the selection, scan [Cancel on page D-2](#).
- **Any Length** - Scan this option to decode Matrix 2 of 5 symbols containing any number of characters within the digital scanner's capability.



*Matrix 2 of 5 - One Discrete Length



Matrix 2 of 5 - Two Discrete Lengths



Matrix 2 of 5 - Length Within Range



Matrix 2 of 5 - Any Length

Matrix 2 of 5 Check Digit

Parameter # F1h 6Eh

The check digit is the last character of the symbol used to verify the integrity of the data. Scan the appropriate bar code below to transmit the bar code data with or without the Matrix 2 of 5 check digit.



Enable Matrix 2 of 5 Check Digit
(01h)



*Disable Matrix 2 of 5 Check Digit
(00h)

Transmit Matrix 2 of 5 Check Digit

Parameter # F1h 6Fh

Scan a bar code below to transmit Matrix 2 of 5 data with or without the check digit.



Transmit Matrix 2 of 5 Check Digit
(01h)



*Do Not Transmit Matrix 2 of 5 Check Digit
(00h)

Korean 3 of 5

Enable/Disable Korean 3 of 5

Parameter # F1h 45h

To enable or disable Korean 3 of 5, scan the appropriate bar code below.

✓ **NOTE** The length for Korean 3 of 5 is fixed at 6.

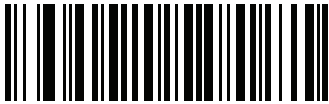

**Enable Korean 3 of 5
(01h)**



***Disable Korean 3 of 5
(00h)**

Inverse 1D

Parameter # F1h 4Ah

This parameter sets the 1D inverse decoder setting. Options are:

- **Regular Only** - the digital scanner decodes regular 1D bar codes only.
- **Inverse Only** - the digital scanner decodes inverse 1D bar codes only.
- **Inverse Autodetect** - the digital scanner decodes both regular and inverse 1D bar codes.



*Regular
(00h)



Inverse Only
(01h)



Inverse Autodetect
(02h)

Postal Codes

US Postnet

Parameter # 59h

To enable or disable US Postnet, scan the appropriate bar code below.



Enable US Postnet
(01h)



*Disable US Postnet
(00h)

US Planet

Parameter # 5Ah

To enable or disable US Planet, scan the appropriate bar code below.



Enable US Planet
(01h)

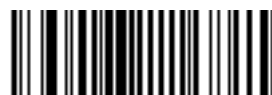

*Disable US Planet
(00h)

Transmit US Postal Check Digit

Parameter # 5Fh

Select whether to transmit US Postal data, which includes both US Postnet and US Planet, with or without the check digit.

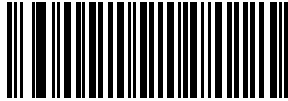

*Transmit US Postal Check Digit
(01h)

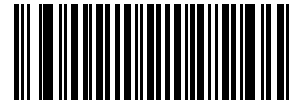

Do Not Transmit US Postal Check Digit
(00h)

UK Postal

Parameter # 5Bh

To enable or disable UK Postal, scan the appropriate bar code below.



Enable UK Postal
(01h)

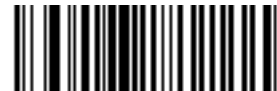

*Disable UK Postal
(00h)

Transmit UK Postal Check Digit

Parameter # 60h

Select whether to transmit UK Postal data with or without the check digit.



***Transmit UK Postal
Check Digit
(01h)**



**Do Not Transmit UK Postal Check Digit
(00h)**

Japan Postal

Parameter # F0h 22h

To enable or disable Japan Postal, scan the appropriate bar code below.



**Enable Japan Postal
(01h)**



***Disable Japan Postal
(00h)**

Australia Post

Parameter # F0h 23h

To enable or disable Australia Post, scan the appropriate bar code below.



**Enable Australia Post
(01h)**



***Disable Australia Post
(00h)**

Australia Post Format

Parameter # F1h CEh

To select one of the following formats for Australia Post, scan the appropriate bar code below:

- **Autodiscriminate** (or Smart mode) - Attempt to decode the Customer Information Field using the N and C Encoding Tables.

✓ **NOTE** This option increases the risk of misdecodes because the encoded data format does not specify the Encoding Table used for encoding.

- **Raw Format** - Output raw bar patterns as a series of numbers 0 through 3.
- **Alphanumeric Encoding** - Decode the Customer Information Field using the C Encoding Table.
- **Numeric Encoding** - Decode the Customer Information Field using the N Encoding Table.

For more information on Australia Post Encoding Tables, refer to the *Australia Post Customer Barcoding Technical Specifications* available at <http://www.auspost.com.au>.



*Autodiscriminate
(00h)



Raw Format
(01h)



Alphanumeric Encoding
(02h)



Numeric Encoding
(03h)

Netherlands KIX Code

Parameter # F0h 46h

To enable or disable Netherlands KIX Code, scan the appropriate bar code below.



Enable Netherlands KIX Code
(01h)



*Disable Netherlands KIX Code
(00h)

USPS 4CB/One Code/Intelligent Mail

Parameter # F1h 50h

To enable or disable USPS 4CB/One Code/Intelligent Mail, scan the appropriate bar code below.



Enable USPS 4CB/One Code/Intelligent Mail
(01h)



*Disable USPS 4CB/One Code/Intelligent Mail
(00h)

UPU FICS Postal

Parameter # F1h 63h

To enable or disable UPU FICS Postal, scan the appropriate bar code below.



Enable UPU FICS Postal
(01h)



*Disable UPU FICS Postal
(00h)

GS1 DataBar

GS1 DataBar types are:

- GS1 DataBar Omnidirectional
- GS1 DataBar Truncated
- GS1 DataBar Stacked
- GS1 DataBar Stacked Omnidirectional
- GS1 DataBar Limited
- GS1 DataBar Expanded
- GS1 DataBar Expanded Stacked

Scan the appropriate bar codes to enable or disable each type of GS1 DataBar.

GS1 DataBar

Parameter # F0h 52h

Scan the appropriate bar code below to enable or disable the following code types:

- GS1 DataBar Omnidirectional
- GS1 DataBar Truncated
- GS1 DataBar Stacked
- GS1 DataBar Stacked Omnidirectional,

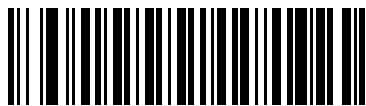

*Enable GS1 DataBar
(01h)

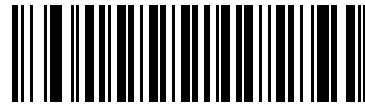

Disable GS1 DataBar
(00h)

GS1 DataBar Limited

Parameter # F0h 53h.

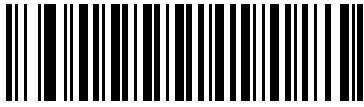

Enable GS1 DataBar Limited
(01h)

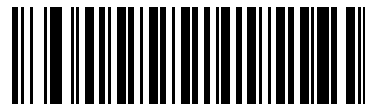

*Disable GS1 DataBar Limited
(00h)

GS1 DataBar Limited Security Level

Parameter # F1h D8h

The digital scanner offers four levels of decode security for GS1 DataBar Limited bar codes. There is an inverse relationship between security and digital scanner aggressiveness. Increasing the level of security may result in reduced aggressiveness in scanning, so only choose the level of security necessary.

- Level 1 – No clear margin required. This complies with the original GS1 standard, yet might result in erroneous¹ decoding of the DataBar Limited bar code when scanning some UPC symbols that start with the digits “9” and “7”.
- Level 2 – Automatic risk detection. This level of security may result in erroneous decoding of DataBar Limited bar codes when scanning some UPC symbols. If a misdecode is detected, the scanner operates in Level 3 or Level 1.
- Level 3 – Security level reflects newly proposed GS1 standard that requires a 5X trailing clear margin.
- Level 4 – Security level extends beyond the standard required by GS1. This level of security requires a 5X leading and trailing clear margin.



Security Level 1
(01h)

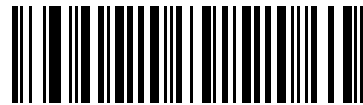

Security Level 2
(02h)



*Security Level 3
(03h)



Security Level 4
(04h)

1. May result in erroneous decoding due to Databar Limited and UPC symbologies.

GS1 DataBar Expanded

Parameter # F0h 54h.

Scan the appropriate bar code below to enable or disable the following code types:

- GS1 DataBar Expanded
- GS1 DataBar Expanded Stacked.

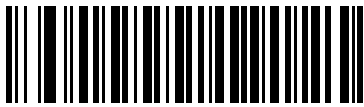

***Enable GS1 DataBar Expanded
(01h)**

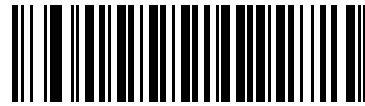

**Disable GS1 DataBar Expanded
(00h)**

Convert GS1 DataBar to UPC/EAN

Parameter # F0h 8Dh

This parameter only applies to GS1 DataBar and GS1 DataBar Limited symbols not decoded as part of a Composite symbol. Enable this to strip the leading '010' from DataBar and DataBar Limited symbols encoding a single zero as the first digit, and report the bar code as EAN-13.

For bar codes beginning with two or more zeros but not six zeros, this parameter strips the leading '0100' and reports the bar code as UPC-A. The UPC-A Preamble parameter that transmits the system character and country code applies to converted bar codes. Note that neither the system character nor the check digit can be stripped.

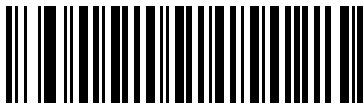

Enable Convert GS1 DataBar to UPC/EAN
(01h)

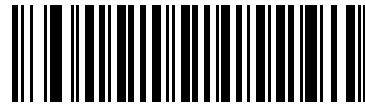

*Disable Convert GS1 DataBar to UPC/EAN
(00h)

Composite

Composite CC-C

Parameter # F0h 55h

Scan a bar code below to enable or disable Composite bar codes of type CC-C.



Enable CC-C
(01h)



*Disable CC-C
(00h)

Composite CC-A/B

Parameter # F0h 56h

Scan a bar code below to enable or disable Composite bar codes of type CC-A/B.



NOTE If you enable this code type, also see [UPC Composite Mode on page 9-74](#).



Enable CC-A/B
(01h)

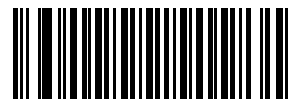

*Disable CC-A/B
(00h)

Composite TLC-39

Parameter # F0h 73h

Scan a bar code below to enable or disable Composite bar codes of type TLC-39.

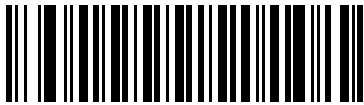

Enable TLC39
(01h)

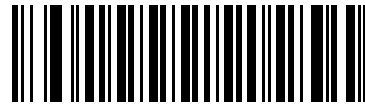

*Disable TLC39
(00h)

UPC Composite Mode

Parameter # F0h 58h

If you enable [Composite CC-A/B on page 9-73](#), select an option for linking UPC symbols with a 2D symbol during transmission as if they were one symbol:

- Select **UPC Never Linked** to transmit UPC bar codes regardless of whether a 2D symbol is detected.
- Select **UPC Always Linked** to transmit UPC bar codes and the 2D portion. If 2D is not present, the UPC bar code does not transmit.
- If you select **Autodiscriminate UPC Composites**, the digital scanner determines if there is a 2D portion, then transmits the UPC, as well as the 2D portion if present.



*UPC Never Linked
(00h)



UPC Always Linked
(01h)



Autodiscriminate UPC Composites
(02h)

Composite Beep Mode

Parameter # F0h 8Eh

To select the number of decode beeps when a composite bar code is decoded, scan the appropriate bar code.

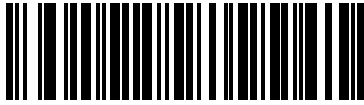

Single Beep After Both are Decoded
(00h)

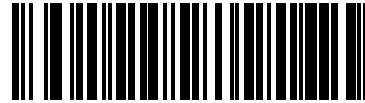

*Beep as Each Code Type is Decoded
(01h)

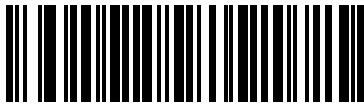

Double Beep After Both are Decoded
(02h)

GS1-128 Emulation Mode for UCC/EAN Composite Codes

Parameter # F0h ABh

Select whether to enable or disable this mode.



Enable GS1-128 Emulation Mode for
UCC/EAN Composite Codes
(01h)



*Disable GS1-128 Emulation Mode for
UCC/EAN Composite Codes
(00h)

2D Symbologies

Enable/Disable PDF417

Parameter # 0Fh

To enable or disable PDF417, scan the appropriate bar code below.



* Enable PDF417
(01h)



Disable PDF417
(00h)

Enable/Disable MicroPDF417

Parameter # E3h

To enable or disable MicroPDF417, scan the appropriate bar code below.



Enable MicroPDF417
(01h)

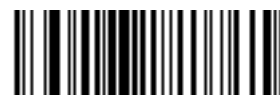

* Disable MicroPDF417
(00h)

Code 128 Emulation

Parameter # 7Bh

Enable this parameter to transmit data from certain MicroPDF417 symbols as Code 128. [AIM Code ID Character \(01h\) on page 4-32](#) must be enabled for this parameter to work.

Enable Code 128 Emulation to transmit these MicroPDF417 symbols with one of the following prefixes:

-]C1 if the first codeword is 903-905
-]C2 if the first codeword is 908 or 909
-]C0 if the first codeword is 910 or 911

Disable Code 128 Emulation to transmit these MicroPDF417 symbols with one of the following prefixes:

-]L3 if the first codeword is 903-905
-]L4 if the first codeword is 908 or 909
-]L5 if the first codeword is 910 or 911

Scan a bar code below to enable or disable Code 128 Emulation.



NOTE Linked MicroPDF codewords 906, 907, 912, 914, and 915 are not supported. Use GS1 Composites instead.



Enable Code 128 Emulation
(01h)



*Disable Code 128 Emulation
(00h)

Data Matrix

Parameter # F0h 24h

To enable or disable Data Matrix, scan the appropriate bar code below.



***Enable Data Matrix
(01h)**



**Disable Data Matrix
(00h)**

Data Matrix Inverse

Parameter # F1h 4Ch

This parameter sets the Data Matrix inverse decoder setting. Options are:

- **Regular Only** - the digital scanner decodes regular Data Matrix bar codes only.
- **Inverse Only** - the digital scanner decodes inverse Data Matrix bar codes only.
- **Inverse Autodetect** - the digital scanner decodes both regular and inverse Data Matrix bar codes.



***Regular
(00h)**



**Inverse Only
(01h)**



**Inverse Autodetect
(02h)**

Maxicode

Parameter # F0h 26h

To enable or disable Maxicode, scan the appropriate bar code below.



Enable Maxicode
(01h)



*Disable Maxicode
(00h)

QR Code

Parameter # F0h25h

To enable or disable QR Code, scan the appropriate bar code below.



*Enable QR Code
(01h)



Disable QR Code
(00h)

QR Inverse

Parameter # F1h 4Bh

This parameter sets the QR inverse decoder setting. Options are:

- **Regular Only** - the digital scanner decodes regular QR bar codes only.
- **Inverse Only** - the digital scanner decodes inverse QR bar codes only.
- **Inverse Autodetect** - the digital scanner decodes both regular and inverse QR bar codes.



*Regular
(00h)



Inverse Only
(01h)



Inverse Autodetect
(02h)

MicroQR

Parameter # F1h 3Dh

To enable or disable MicroQR, scan the appropriate bar code below.



*Enable MicroQR
(01h)



Disable MicroQR
(00h)

Aztec

Parameter # F1h 3Eh

To enable or disable Aztec, scan the appropriate bar code below.



*Enable Aztec
(01h)



Disable Aztec
(00h)

Aztec Inverse

Parameter # F1h 4Dh

This parameter sets the Aztec inverse decoder setting. Options are:

- **Regular Only** - the digital scanner decodes regular Aztec bar codes only.
- **Inverse Only** - the digital scanner decodes inverse Aztec bar codes only.
- **Inverse Autodetect** - the digital scanner decodes both regular and inverse Aztec bar codes.



Regular
(00h)



Inverse Only
(01h)



* Inverse Autodetect
(02h)

Redundancy Level

Parameter # 4Eh

The digital scanner offers four levels of decode redundancy. Select higher redundancy levels for decreasing levels of bar code quality. As redundancy levels increase, the digital scanner's aggressiveness decreases.

Select the redundancy level appropriate for the bar code quality.

Redundancy Level 1

The following code types must be successfully read twice before being decoded:

Table 9-2 *Redundancy Level 1 Codes*

Code Type	Code Length
Codabar	8 characters or less
MSI	4 characters or less
D 2 of 5	8 characters or less
I 2 of 5	8 characters or less

Redundancy Level 2

The following code types must be successfully read twice before being decoded:

Table 9-3 *Redundancy Level 2 Codes*

Code Type	Code Length
All	All

Redundancy Level 3

Code types other than the following must be successfully read twice before being decoded. The following codes must be read three times:

Table 9-4 *Redundancy Level 3 Codes*

Code Type	Code Length
MSI	4 characters or less
D 2 of 5	8 characters or less
I 2 of 5	8 characters or less
Codabar	8 characters or less

Redundancy Level 4

The following code types must be successfully read three times before being decoded:

Table 9-5 *Redundancy Level 4 Codes*

Code Type	Code Length
All	All

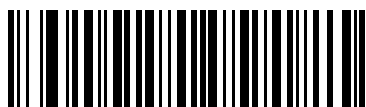

*Redundancy Level 1
(01h)



Redundancy Level 2
(02h)

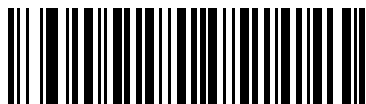

Redundancy Level 3
(03h)



Redundancy Level 4
(04h)

Security Level

Parameter # 4Dh

The digital scanner offers four levels of decode security for delta bar codes, which include UPC/EAN and Code 93. Select increasing levels of security for decreasing levels of bar code quality. There is an inverse relationship between security and digital scanner aggressiveness, so choose only that level of security necessary for any given application.

- **Security Level 0:** This setting allows the digital scanner to operate in its most aggressive state, while providing sufficient security in decoding most “in-spec” bar codes.
- **Security Level 1:** This default setting eliminates most misdecodes.
- **Security Level 2:** Select this option if Security level 1 fails to eliminate misdecodes.
- **Security Level 3:** If you selected Security Level 2 and misdecodes still occur, select this security level. Be advised, selecting this option is an extreme measure against mis-decoding severely out of spec bar codes. Selecting this level of security significantly impairs the decoding ability of the digital scanner. If you need this level of security, try to improve the quality of the bar codes.

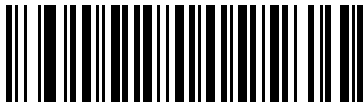

Security Level 0
(00h)



*Security Level 1
(01h)

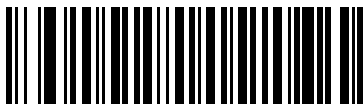

Security Level 2
(02h)



Security Level 3
(03h)

Intercharacter Gap Size

Parameter # F0h 7Dh

The Code 39 and Codabar symbologies have an intercharacter gap that is typically quite small. Due to various bar code-printing technologies, this gap can grow larger than the maximum size allowed, preventing the digital scanner from decoding the symbol. If this problem occurs, scan the **Large Intercharacter Gaps** parameter to tolerate these out-of-specification bar codes.



*Normal Intercharacter Gaps
(06h)



Large Intercharacter Gaps
(0Ah)

Macro PDF Features

Macro PDF is a special feature for concatenating multiple PDF symbols into one file. The scanner can decode symbols that are encoded with this feature, and can store more than 64 Kb of decoded data stored in up to 50 MacroPDF symbols.



CAUTION When printing, keep each Macro PDF sequence separate, as each sequence has unique identifiers. Do not mix bar codes from several Macro PDF sequences, even if they encode the same data. When scanning Macro PDF sequences, scan the entire Macro PDF sequence without interruption. If, when scanning a mixed sequence, the digital scanner emits two long low beeps (Low/Low) this indicates an inconsistent file ID or inconsistent symbology error.

Flush Macro Buffer

This flushes the buffer of all decoded Macro PDF data stored to that point, transmits it to the host device, and aborts from Macro PDF mode.

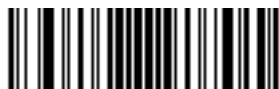

Flush Macro PDF Buffer

Abort Macro PDF Entry

This clears all currently-stored Macro PDF data in the buffer without transmission and aborts from Macro PDF mode.



Abort Macro PDF Entry

Chapter 10 123Scan²

Introduction

123Scan² is an easy to use, PC-based software tool that enables rapid customized setup of scanners by Motorola.

123Scan² uses a wizard tool to guide users through a streamlined set up process. Settings are saved in a configuration file that can be distributed via e-mail, electronically downloaded via a USB cable, or used to generate a sheet of scannable programming bar codes.

Additionally 123Scan² can upgrade scanner firmware, check online to enable support for newly released products, generate a collection of multi-setting bar codes if the number of settings is very large, stage large number of scanners simultaneously, generate reports with asset tracking information and create custom products.

Communication with 123Scan²

To communicate with the 123Scan² program which runs on a host computer running a Windows XP SP2 or Windows Vista operating system, use a USB cable to connect the digital scanner to the host computer (see [Connecting a USB Interface on page 5-2](#)).

123Scan² Requirements

- Host computer with Windows XP SP2 or Windows Vista
- Scanner
- Cradle
- USB cable.

For more information on 123Scan², go to:
<http://www.motorola.com/123Scan2>

To download 123Scan² software and access the Help file integrated in the utility, go to:
<http://support.symbol.com/support/product/123Scan2.html>

Chapter 11 Advanced Data Formatting

Introduction

Advanced Data Formatting (ADF) is a means of customizing data before transmission to the host device. Use ADF to edit scan data to suit requirements. Implement ADF by scanning a related series of bar codes which program the digital scanner with ADF rules.

For information and programming bar codes for ADF, refer to the *Advanced Data Formatting Programmer Guide*, p/n 72E-69680-xx.

Appendix A Standard Default Parameters

Table A-1 Standard Default Parameters Table

Parameter	Parameter Number	Default	Page Number
User Preferences			
Set Default Parameter		Set Defaults	4-4
Parameter Bar Code Scanning	ECh	Enable	4-5
Beep After Good Decode	38h	Enable	4-5
Beeper Tone	91h	Medium	4-6
Beeper Volume	8Ch	High	4-7
Beeper Duration	F1h 74h	Medium	4-7
Suppress Power-up Beeps	F1h D1h	Do not suppress	4-8
Low Power Mode	80h	Disable	4-8
Time Delay to Low Power Mode	92h	1 Hour	4-9
Hand-Held Trigger Mode	8Ah	Auto Aim	4-11
Picklist Mode	F0h 92h	Always Disabled	4-12
Continuous Bar Code Read	F1h 89h	Disable	4-13
Unique Bar Code Reporting	F1h D31h	Disable	4-13
Decode Session Timeout	88h	9.9 Sec	4-14
Timeout Between Decodes, Same Symbol	89h	0.5 Sec	4-14
Timeout Between Decodes, Different Symbols	90h	0.2 Sec	4-15
Fuzzy 1D Processing	F1h 02h	Enable	4-15

¹User selection is required to configure this interface and this is the most common selection.

Table A-1 Standard Default Parameters Table (Continued)

Parameter	Parameter Number	Default	Page Number
Decode Mirror Images (Data Matrix Only)	F1h 19h	Auto	4-16
Mobile Phone/Display Mode	F1h CCh	Enable in Both Hand-Held and Hands-Free Modes	4-17
PDF Prioritization	F1h CFh	Disable	4-18
PDF Prioritization Timeout	F1h D0h	200 ms	4-18
Hand-Held Decode Aiming Pattern	F0h 32h	Enable	4-19
Hands-Free Decode Aiming Pattern	F1h 4Eh	Enable Hands-Free Decode Aiming Pattern on PDF	4-20
Presentation Mode Field of View	F1h 61h	Full	4-21
Decoding Illumination	F0h 2Ah	Enable	4-22
Multicode Mode	F1h A5h	Disable	4-22
Multicode Expression	F1h 95h	1	4-23
Multicode Mode Concatenation	F1h CDh	Disable	4-28
Multicode Concatenation Symbology	F1h D2h	Concatenate as PDF417	4-29
Miscellaneous Options			
Transmit Code ID Character	2Dh	None	4-32
Prefix Value	63h 69h	7013 <CR><LF>	4-33
Suffix 1 Value Suffix 2 Value	62h 68h 64h 6Ah	7013 <CR><LF>	4-33
Scan Data Transmission Format	EBh	Data as is	4-34
FN1 Substitution Values	67h 6Dh	7013 <CR> <LF>	4-35
Transmit "No Read" Message	5Eh	Disable	4-36
USB Host Parameters			
USB Device Type		HID Keyboard Emulation	5-5
Symbol Native API (SNAPI) Status Handshaking		Enable	5-6
USB Country Keyboard Types (Country Codes)		North American	5-7
USB Keystroke Delay		No Delay	5-9
Simulated Caps Lock		Disable	5-10
USB CAPS Lock Override		Disable	5-10

¹User selection is required to configure this interface and this is the most common selection.

Table A-1 Standard Default Parameters Table (Continued)

Parameter	Parameter Number	Default	Page Number
USB Ignore Unknown Characters		Enable	5-11
USB Convert Unknown to Code 39		Disable	5-11
USB Ignore Beep Directive		Honor	5-12
USB Ignore Type Directive		Honor	5-12
Emulate Keypad		Disable	5-13
Emulate Keypad with Leading Zero		Disable	5-13
USB Keyboard FN1 Substitution		Disable	5-14
Function Key Mapping		Disable	5-14
Convert Case		No Case Conversion	5-15
USB Static CDC		Enable	5-15
USB Polling Interval		8 msec	5-16
Quick Keypad Emulation		Disable	5-18
RS-232 Host Parameters			
RS-232 Host Types		Standard ¹	6-6
Baud Rate		9600	6-8
Parity Type		None	6-9
Data Bits		8-Bit	6-10
Stop Bits		1 Stop Bit	6-10
Check Receive Errors		Enable	6-11
Hardware Handshaking		None	6-11
Software Handshaking		None	6-13
Host Serial Response Time-out		2 Sec	6-15
RTS Line State		Low RTS	6-16
Beep on <BEL>		Disable	6-16
Intercharacter Delay		0 msec	6-17
Nixdorf Beep/LED Options		Normal Operation	6-18
Ignore Unknown Characters		Send Bar Code	6-18
IBM 468X/469X Host Parameters			
Port Address		None Selected	7-4
Convert Unknown to Code 39		Disable	7-5

¹User selection is required to configure this interface and this is the most common selection.

Table A-1 Standard Default Parameters Table (Continued)

Parameter	Parameter Number	Default	Page Number
Ignore Beep Directive		Honor	7-5
Ignore Configuration Directive		Honor	7-6
Keyboard Wedge Host Parameters			
Keyboard Wedge Host Type		IBM PC/AT& IBM PC Compatibles ¹	8-4
Country Types (Country Codes)		North American	8-5
Ignore Unknown Characters		Transmit	8-7
Keystroke Delay		No Delay	8-7
Intra-Keystroke Delay		Disable	8-8
Alternate Numeric Keypad Emulation		Disable	8-8
Simulated Caps Lock		Disable	8-9
Caps Lock Override		Disable	8-9
Convert Wedge Case		No Convert	8-10
Function Key Mapping		Disable	8-10
FN1 Substitution		Disable	8-11
Send Make and Break		Send	8-11
Disable All Code Types			9-7
UPC/EAN			
UPC-A	01h	Enable	9-8
UPC-E	02h	Enable	9-8
UPC-E1	0Ch	Disable	9-9
EAN-8/JAN 8	04h	Enable	9-9
EAN-13/JAN 13	03h	Enable	9-10
Bookland EAN	53h	Enable	9-10
Bookland ISBN Format	F1h 40h	ISBN-10	9-11
Decode UPC/EAN/JAN Supplementals (2 and 5 digits)	10h	Ignore	9-13
User-Programmable Supplementals		N/A	9-15
Supplemental 1:	F1h 43h		
Supplemental 2:	F1h 44h		
UPC/EAN/JAN Supplemental Redundancy	50h	10	9-15

¹User selection is required to configure this interface and this is the most common selection.

Table A-1 Standard Default Parameters Table (Continued)

Parameter	Parameter Number	Default	Page Number
Decode UPC/EAN/JAN Supplemental AIM ID	F1h A0h	Combined	9-16
Transmit UPC-A Check Digit	28h	Enable	9-17
Transmit UPC-E Check Digit	29h	Enable	9-17
Transmit UPC-E1 Check Digit	2Ah	Enable	9-18
UPC-A Preamble	22h	System Character	9-18
UPC-E Preamble	23h	System Character	9-18
UPC-E1 Preamble	24h	System Character	9-20
Convert UPC-E to A	25h	Disable	9-21
Convert UPC-E1 to A	26h	Disable	9-21
EAN-8/JAN-8 Extend	27h	Disable	9-22
UCC Coupon Extended Code	55h	Disable	9-22
Coupon Report	F1h DAh	New Coupon Symbols	9-23
ISSN EAN	F1h 69h	Enable	9-24
Code 128			
Code 128	08h	Enable	9-25
Set Length(s) for Code 128	D1h, D2h	Any Length	9-25
GS1-128 (formerly UCC/EAN-128)	0Eh	Enable	9-26
ISBT 128	54h	Enable	9-27
ISBT Concatenation	F1h 41h	Disable	9-28
Check ISBT Table	F1h 42h	Enable	9-29
ISBT Concatenation Redundancy	DFh	10	9-29
Code 39			
Code 39	00h	Enable	9-30
Trioptic Code 39	0Dh	Disable	9-30
Convert Code 39 to Code 32 (Italian Pharmacy Code)	56h	Disable	9-31
Code 32 Prefix	E7h	Disable	9-31
Set Length(s) for Code 39	12h 13h	Length Within Range: 2 to 55	9-32
Code 39 Check Digit Verification	30h	Disable	9-33
Transmit Code 39 Check Digit	2Bh	Disable	9-33

¹User selection is required to configure this interface and this is the most common selection.

Table A-1 Standard Default Parameters Table (Continued)

Parameter	Parameter Number	Default	Page Number
Code 39 Full ASCII Conversion	11h	Disable	9-34
Buffer Code 39	71h	Disable	9-35
Code 93			
Code 93	09h	Disable	9-37
Set Length(s) for Code 93	1Ah, 1Bh	Length Within Range: 4 to 55	9-37
Code 11			
Code 11	0Ah	Disable	9-39
Set Lengths for Code 11	1Ch, 1Dh	Length Within Range: 4 to 55	9-39
Code 11 Check Digit Verification	34h	Disable	9-41
Transmit Code 11 Check Digit(s)	2Fh	Disable	9-42
Interleaved 2 of 5 (ITF)			
Interleaved 2 of 5 (ITF)	06h	Disable	9-42
Set Lengths for I 2 of 5	16h, 17h	1 Length; Length = 14	9-43
I 2 of 5 Check Digit Verification	31h	Disable	9-45
Transmit I 2 of 5 Check Digit	2Ch	Disable	9-45
Convert I 2 of 5 to EAN 13	52h	Disable	9-46
Discrete 2 of 5 (DTF)			
Discrete 2 of 5	05h	Disable	9-46
Set Length(s) for D 2 of 5	14h, 15h	1 Length; Length = 12	9-47
Codabar (NW - 7)			
Codabar	07h	Disable	9-49
Set Lengths for Codabar	18h, 19h	Length Within Range: 5 to 55	9-49
CLSI Editing	36h	Disable	9-51
NOTIS Editing	37h	Disable	9-51
MSI			
MSI	0Bh	Disable	9-52
Set Length(s) for MSI	1Eh, 1Fh	Length Within Range: 4 to 55	9-52
MSI Check Digits	32h	One	9-54

¹User selection is required to configure this interface and this is the most common selection.

Table A-1 Standard Default Parameters Table (Continued)

Parameter	Parameter Number	Default	Page Number
Transmit MSI Check Digit	2Eh	Disable	9-54
MSI Check Digit Algorithm	33h	Mod 10/Mod 10	9-55
Chinese 2 of 5			
Chinese 2 of 5	F0h 98h	Disable	9-55
Matrix 2 of 5			
Matrix 2 of 5	F1h 6Ah	Disable	9-56
Matrix 2 of 5 Lengths	F1h 6Bh F1h 6Ch	Length; Length = 14	9-57
Matrix 2 of 5 Check Digit	F1h 6Eh	Disable	9-58
Transmit Matrix 2 of 5 Check Digit	F1h 6Fh	Disable	9-58
Korean 3 of 5			
Korean 3 of 5	F1h 45h	Disable	9-59
Inverse 1D	F1h 4Ah	Regular	9-60
Postal Codes			
US Postnet	59h	Disable	9-61
US Planet	5Ah	Disable	9-61
Transmit US Postal Check Digit	5Fh	Enable	9-62
UK Postal	5Bh	Disable	9-62
Transmit UK Postal Check Digit	60h	Enable	9-63
Japan Postal	F0h 22h	Disable	9-63
Australia Post	F0h 23h	Disable	9-64
Australia Post Format	F1h CEh	Autodiscriminate	9-65
Netherlands KIX Code	F0h 46h	Disable	9-66
USPS 4CB/One Code/Intelligent Mail	F1h 50h	Disable	9-66
UPU FICS Postal	F1h 63h	Disable	9-67
GS1 DataBar			
GS1 DataBar (GS1 DataBar Omnidirectional, GS1 DataBar Truncated, GS1 DataBar Stacked, GS1 DataBar Stacked Omnidirectional)	F0h 52h	Enable	9-68
GS1 DataBar Limited	F0h 53h	Disable	9-69

¹User selection is required to configure this interface and this is the most common selection.

Table A-1 Standard Default Parameters Table (Continued)

Parameter	Parameter Number	Default	Page Number
GS1 DataBar Expanded (GS1 DataBar Expanded, GS1 DataBar Expanded Stacked)	F0h 54h	Enable	9-71
GS1 DataBar Limited Security Level	F1h D8h	3	9-71
Convert GS1 DataBar to UPC/EAN	F0h 8Dh	Disable	9-72
Composite			
Composite CC-C	F0h 55h	Disable	9-73
Composite CC-A/B	F0h 56h	Disable	9-73
Composite TLC-39	F0h 73h	Disable	9-74
UPC Composite Mode	F0h 58h	Never Linked	9-74
Composite Beep Mode	F0h 8Eh	Beep As Each Code Type is Decoded	9-75
GS1-128 Emulation Mode for UCC/EAN Composite Codes	F0h ABh	Disable	9-75
2D Symbolgies			
PDF417	0Fh	Enable	9-76
MicroPDF417	E3h	Disable	9-76
Code 128 Emulation	7Bh	Disable	9-77
Data Matrix	F0h 24h	Enable	9-78
Data Matrix Inverse	F1h 4Ch	Regular	9-78
Maxicode	F0h 26h	Disable	9-79
QR Code	F0h 25h	Enable	9-79
QR Inverse	F1h 4Bh	Regular	9-80
MicroQR	F1h 3Dh	Enable	9-80
Aztec	F1h 3Eh	Enable	9-81
Aztec Inverse	F1h 4Dh	Inverse Autodetect	9-81
Symbology-Specific Security Levels			
Redundancy Level	4Eh	1	9-82
Security Level (UPC/EAN and Code 93)	4Dh	1	9-84
Intercharacter Gap Size	F0h 7Dh	Normal	9-85

¹User selection is required to configure this interface and this is the most common selection.

Table A-1 Standard Default Parameters Table (Continued)

Parameter	Parameter Number	Default	Page Number
Macro PDF			
Flush Macro PDF Buffer			9-86
Abort Macro PDF Entry			9-86
¹User selection is required to configure this interface and this is the most common selection.			

Appendix B Programming Reference

Symbol Code Identifiers

Table B-1 *Symbol Code Characters*

Code Character	Code Type
A	UPC-A, UPC-E, UPC-E1, EAN-8, EAN-13
B	Code 39, Code 32
C	Codabar
D	Code 128, ISBT 128, ISBT 128 Concatenated
E	Code 93
F	Interleaved 2 of 5
G	Discrete 2 of 5, or Discrete 2 of 5 IATA
H	Code 11
J	MSI
K	GS1-128
L	Bookland EAN
M	Trioptic Code 39
N	Coupon Code
R	GS1 DataBar Family
S	Matrix 2 of 5
T	UCC Composite, TLC 39
U	Chinese 2 of 5

Table B-1 *Symbol Code Characters (Continued)*

Code Character	Code Type
V	Korean 3 of 5
X	ISSN EAN, PDF417, Macro PDF417, Micro PDF417
z	Aztec, Aztec Rune
P00	Data Matrix
P01	QR Code, MicroQR
P02	Maxicode
P03	US Postnet
P04	US Planet
P05	Japan Postal
P06	UK Postal
P08	Netherlands KIX Code
P09	Australia Post
P0A	USPS 4CB/One Code/Intelligent Mail
P0B	UPU FICS Postal
P0X	Signature Capture

AIM Code Identifiers

Each AIM Code Identifier contains the three-character string **Jcm** where:

- J = Flag Character (ASCII 93)
- c = Code Character (see [Table B-2](#))
- m = Modifier Character (see [Table B-3](#))

Table B-2 *Aim Code Characters*

Code Character	Code Type
A	Code 39, Code 39 Full ASCII, Code 32
C	Code 128, ISBT 128, ISBT 128 Concatenated, GS1-128, Coupon (Code 128 portion)
d	Data Matrix
E	UPC/EAN, Coupon (UPC portion)
e	GS1 DataBar Family
F	Codabar
G	Code 93
H	Code 11
I	Interleaved 2 of 5
L	PDF417, Macro PDF417, Micro PDF417
L2	TLC 39
M	MSI
Q	QR Code, MicroQR
S	Discrete 2 of 5, IATA 2 of 5
U	Maxicode
z	Aztec, Aztec Rune
X	Bookland EAN, ISSN EAN, Trioptic Code 39, Chinese 2 of 5, Matrix 2 of 5, Korean 3 of 5, US Postnet, US Planet, UK Postal, Japan Postal, Australia Post, Netherlands KIX Code, USPS 4CB/One Code/ Intelligent Mail, UPU FICS Postal, Signature Capture

The modifier character is the sum of the applicable option values based on [Table B-3](#).

Table B-3 *Modifier Characters*

Code Type	Option Value	Option
Code 39	0	No check character or Full ASCII processing.
	1	Reader has checked one check character.
	3	Reader has checked and stripped check character.
	4	Reader has performed Full ASCII character conversion.
	5	Reader has performed Full ASCII character conversion and checked one check character.
	7	Reader has performed Full ASCII character conversion and checked and stripped check character.
	Example: A Full ASCII bar code with check character W, A+I+MI+DW , is transmitted as J A7 AIMID where 7 = (3+4).	
Trioptic Code 39	0	No option specified at this time. Always transmit 0.
	Example: A Trioptic bar code 412356 is transmitted as J X0 412356	
Code 128	0	Standard data packet, no Function code 1 in first symbol position.
	1	Function code 1 in first symbol character position.
	2	Function code 1 in second symbol character position.
	Example: A Code (EAN) 128 bar code with Function 1 character ^{FNC1} in the first position, AIMID is transmitted as J C1 AIMID	
I 2 of 5	0	No check digit processing.
	1	Reader has validated check digit.
	3	Reader has validated and stripped check digit.
	Example: An I 2 of 5 bar code without check digit, 4123, is transmitted as J I0 4123	
Codabar	0	No check digit processing.
	1	Reader has checked check digit.
	3	Reader has stripped check digit before transmission.
	Example: A Codabar bar code without check digit, 4123, is transmitted as J F0 4123	
Code 93	0	No options specified at this time. Always transmit 0.
	Example: A Code 93 bar code 012345678905 is transmitted as J G00 12345678905	
MSI	0	Check digits are sent.
	1	No check digit is sent.
	Example: An MSI bar code 4123, with a single check digit checked, is transmitted as J M1 4123	

Table B-3 Modifier Characters (Continued)

Code Type	Option Value	Option
D 2 of 5	0	No options specified at this time. Always transmit 0.
		Example: A D 2 of 5 bar code 4123, is transmitted as JS04123
UPC/EAN	0	Standard data packet in full EAN format, i.e. 13 digits for UPC-A, UPC-E, and EAN-13 (not including supplemental data).
	1	Two digit supplemental data only.
	2	Five digit supplemental data only.
	3	Combined data packet comprising 13 digits from EAN-13, UPC-A or UPC-E symbol and 2 or 5 digits from supplemental symbol.
	4	EAN-8 data packet.
		Example: A UPC-A bar code 012345678905 is transmitted as JE00012345678905
Bookland EAN	0	No options specified at this time. Always transmit 0.
		Example: A Bookland EAN bar code 123456789X is transmitted as JX0123456789X
ISSN EAN	0	No options specified at this time. Always transmit 0.
		Example: An ISSN EAN bar code 123456789X is transmitted as JX0123456789X
Code 11	0	Single check digit
	1	Two check digits
	3	Check characters validated but not transmitted.
GS1 DataBar Family		No option specified at this time. Always transmit 0. GS1 DataBar-14 and GS1 DataBar Limited transmit with an Application Identifier "01". Note: In GS1-128 emulation mode, GS1 DataBar is transmitted using Code 128 rules (i.e., J C1).
		Example: A GS1 DataBar-14 bar code 0110012345678902 is transmitted as Je00110012345678902 .
EAN.UCC Composites (GS1 DataBar, GS1-128, 2D portion of UPC composite)		Native mode transmission. Note: UPC portion of composite is transmitted using UPC rules.
	0	Standard data packet.
	1	Data packet containing the data following an encoded symbol separator character.
	2	Data packet containing the data following an escape mechanism character. The data packet does not support the ECI protocol.
	3	Data packet containing the data following an escape mechanism character. The data packet supports the ECI protocol.
		GS1-128 emulation Note: UPC portion of composite is transmitted using UPC rules.
	1	Data packet is a GS1-128 symbol (i.e., data is preceded with J C1).

Table B-3 *Modifier Characters (Continued)*

Code Type	Option Value	Option
PDF417, Micro PDF417	0	Reader set to conform to protocol defined in 1994 PDF417 symbology specifications. Note: When this option is transmitted, the receiver cannot reliably determine whether ECIs have been invoked or whether data byte 92 _{DEC} has been doubled in transmission.
	1	Reader set to follow the ECI protocol (Extended Channel Interpretation). All data characters 92 _{DEC} are doubled.
	2	Reader set for Basic Channel operation (no escape character transmission protocol). Data characters 92 _{DEC} are not doubled. Note: When decoders are set to this mode, unbuffered Macro symbols and symbols requiring the decoder to convey ECI escape sequences cannot be transmitted.
	3	The bar code contains a GS1-128 symbol, and the first codeword is 903-907, 912, 914, 915.
	4	The bar code contains a GS1-128 symbol, and the first codeword is in the range 908-909.
	5	The bar code contains a GS1-128 symbol, and the first codeword is in the range 910-911.
	Example: A PDF417 bar code ABCD, with no transmission protocol enabled, is transmitted as]L2ABCD.	
Data Matrix	0	ECC 000-140, not supported.
	1	ECC 200.
	2	ECC 200, FNC1 in first or fifth position.
	3	ECC 200, FNC1 in second or sixth position.
	4	ECC 200, ECI protocol implemented.
	5	ECC 200, FNC1 in first or fifth position, ECI protocol implemented.
	6	ECC 200, FNC1 in second or sixth position, ECI protocol implemented.
MaxiCode	0	Symbol in Mode 4 or 5.
	1	Symbol in Mode 2 or 3.
	2	Symbol in Mode 4 or 5, ECI protocol implemented.
	3	Symbol in Mode 2 or 3, ECI protocol implemented in secondary message.

Table B-3 *Modifier Characters (Continued)*

Code Type	Option Value	Option
QR Code	0	Model 1 symbol.
	1	Model 2 / MicroQR symbol, ECI protocol not implemented.
	2	Model 2 symbol, ECI protocol implemented.
	3	Model 2 symbol, ECI protocol not implemented, FNC1 implied in first position.
	4	Model 2 symbol, ECI protocol implemented, FNC1 implied in first position.
	5	Model 2 symbol, ECI protocol not implemented, FNC1 implied in second position.
	6	Model 2 symbol, ECI protocol implemented, FNC1 implied in second position.
Aztec	0	Aztec symbol.
	C	Aztec Rune symbol.

Appendix C Sample Bar Codes

Code 39



UPC/EAN

UPC-A, 100%



EAN-13, 100%



Code 128



Interleaved 2 of 5



GS1 DataBar-14

✓ **NOTE** DataBar-14 must be enabled to read the bar code below (see [GS1 DataBar on page 9-68](#)).



7612341562341

PDF417



Data Matrix



Maxicode

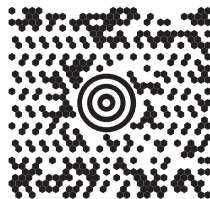

QR Code



US Postnet



UK Postal



Appendix D Numeric Bar Codes

Numeric Bar Codes

For parameters requiring specific numeric values, scan the appropriately numbered bar code(s).



Numeric Bar Codes (continued)



5



6



7



8



9

Cancel

To correct an error or change a selection, scan the bar code below.



Cancel

Appendix E ASCII Character Sets

Table E-1 ASCII Value Table

ASCII Value	Full ASCII Code 39 Encode Char	Keystroke
1000	%U	CTRL 2
1001	\$A	CTRL A
1002	\$B	CTRL B
1003	\$C	CTRL C
1004	\$D	CTRL D
1005	\$E	CTRL E
1006	\$F	CTRL F
1007	\$G	CTRL G
1008	\$H	CTRL H/ BACKSPACE ¹
1009	\$I	CTRL I/ HORIZONTAL TAB ¹
1010	\$J	CTRL J
1011	\$K	CTRL K
1012	\$L	CTRL L
1013	\$M	CTRL M/ ENTER ¹
1014	\$N	CTRL N
1015	\$O	CTRL O

The keystroke in bold transmits only if you enabled Function Key Mapping. Otherwise, the unbold keystroke transmits.

Table E-1 ASCII Value Table (Continued)

ASCII Value	Full ASCII Code 39 Encode Char	Keystroke
1016	\$P	CTRL P
1017	\$Q	CTRL Q
1018	\$R	CTRL R
1019	\$S	CTRL S
1020	\$T	CTRL T
1021	\$U	CTRL U
1022	\$V	CTRL V
1023	\$W	CTRL W
1024	\$X	CTRL X
1025	\$Y	CTRL Y
1026	\$Z	CTRL Z
1027	%A	CTRL [
1028	%B	CTRL \
1029	%C	CTRL]
1030	%D	CTRL 6
1031	%E	CTRL -
1032	Space	Space
1033	/A	!
1034	/B	"
1035	/C	#
1036	/D	\$
1037	/E	%
1038	/F	&
1039	/G	'
1040	/H	(
1041	/I)
1042	/J	*
1043	/K	+

The keystroke in bold transmits only if you enabled Function Key Mapping. Otherwise, the unbold keystroke transmits.

Table E-1 ASCII Value Table (Continued)

ASCII Value	Full ASCII Code 39 Encode Char	Keystroke
1044	/L	,
1045	-	-
1046	.	.
1047	/o	/
1048	0	0
1049	1	1
1050	2	2
1051	3	3
1052	4	4
1053	5	5
1054	6	6
1055	7	7
1056	8	8
1057	9	9
1058	/Z	:
1059	%F	;
1060	%G	<
1061	%H	=
1062	%I	>
1063	%J	?
1064	%V	@
1065	A	A
1066	B	B
1067	C	C
1068	D	D
1069	E	E
1070	F	F
1071	G	G

The keystroke in bold transmits only if you enabled Function Key Mapping. Otherwise, the unbold keystroke transmits.

Table E-1 ASCII Value Table (Continued)

ASCII Value	Full ASCII Code 39 Encode Char	Keystroke
1072	H	H
1073	I	I
1074	J	J
1075	K	K
1076	L	L
1077	M	M
1078	N	N
1079	O	O
1080	P	P
1081	Q	Q
1082	R	R
1083	S	S
1084	T	T
1085	U	U
1086	V	V
1087	W	W
1088	X	X
1089	Y	Y
1090	Z	Z
1091	%K	[
1092	%L	\
1093	%M]
1094	%N	^
1095	%O	_
1096	%W	'
1097	+A	a
1098	+B	b
1099	+C	c

The keystroke in bold transmits only if you enabled Function Key Mapping. Otherwise, the unbold keystroke transmits.

Table E-1 ASCII Value Table (Continued)

ASCII Value	Full ASCII Code 39 Encode Char	Keystroke
1100	+D	d
1101	+E	e
1102	+F	f
1103	+G	g
1104	+H	h
1105	+I	i
1106	+J	j
1107	+K	k
1108	+L	l
1109	+M	m
1110	+N	n
1111	+O	o
1112	+P	p
1113	+Q	q
1114	+R	r
1115	+S	s
1116	+T	t
1117	+U	u
1118	+V	v
1119	+W	w
1120	+X	x
1121	+Y	y
1122	+Z	z
1123	%P	{
1124	%Q	
1125	%R	}
1126	%S	~

The keystroke in bold transmits only if you enabled Function Key Mapping. Otherwise, the unbold keystroke transmits.

Table E-2 *ALT Key Standard Default Tables*

ALT Keys	Keystroke
2064	ALT 2
2065	ALT A
2066	ALT B
2067	ALT C
2068	ALT D
2069	ALT E
2070	ALT F
2071	ALT G
2072	ALT H
2073	ALT I
2074	ALT J
2075	ALT K
2076	ALT L
2077	ALT M
2078	ALT N
2079	ALT O
2080	ALT P
2081	ALT Q
2082	ALT R
2083	ALT S
2084	ALT T
2085	ALT U
2086	ALT V
2087	ALT W
2088	ALT X
2089	ALT Y
2090	ALT Z

Table E-3 *USB GUI Key Character Set*

GUI Key	Keystroke
3000	Right Control Key
3048	GUI 0
3049	GUI 1
3050	GUI 2
3051	GUI 3
3052	GUI 4
3053	GUI 5
3054	GUI 6
3055	GUI 7
3056	GUI 8
3057	GUI 9
3065	GUI A
3066	GUI B
3067	GUI C
3068	GUI D
3069	GUI E
3070	GUI F
3071	GUI G
3072	GUI H
3073	GUI I
3074	GUI J
3075	GUI K
3076	GUI L
3077	GUI M
3078	GUI N
3079	GUI O
3080	GUI P

Note: GUI Shift Keys - The Apple™ iMac keyboard has an apple key on either side of the space bar. Windows-based systems have a GUI key to the left of the left ALT key, and to the right of the right ALT key.

Table E-3 *USB GUI Key Character Set (Continued)*

GUI Key	Keystroke
3081	GUI Q
3082	GUI R
3083	GUI S
3084	GUI T
3085	GUI U
3086	GUI V
3087	GUI W
3088	GUI X
3089	GUI Y
3090	GUI Z

Note: GUI Shift Keys - The Apple™ iMac keyboard has an apple key on either side of the space bar. Windows-based systems have a GUI key to the left of the left ALT key, and to the right of the right ALT key.

Table E-4 *PF Key Standard Default Table*

PF Keys	Keystroke
4001	PF 1
4002	PF 2
4003	PF 3
4004	PF 4
4005	PF 5
4006	PF 6
4007	PF 7
4008	PF 8
4009	PF 9
4010	PF 10
4011	PF 11
4012	PF 12
4013	PF 13
4014	PF 14
4015	PF 15
4016	PF 16

Table E-5 *F key Standard Default Table*

F Keys	Keystroke
5001	F 1
5002	F 2
5003	F 3
5004	F 4
5005	F 5
5006	F 6
5007	F 7
5008	F 8
5009	F 9
5010	F 10
5011	F 11
5012	F 12
5013	F 13
5014	F 14
5015	F 15
5016	F 16
5017	F 17
5018	F 18
5019	F 19
5020	F 20
5021	F 21
5022	F 22
5023	F 23
5024	F 24

Table E-6 *Numeric Key Standard Default Table*

Numeric Keypad	Keystroke
6042	*
6043	+
6044	Undefined
6045	-
6046	.
6047	/
6048	0
6049	1
6050	2
6051	3
6052	4
6053	5
6054	6
6055	7
6056	8
6057	9
6058	Enter
6059	Num Lock

Table E-7 *Extended Keypad Standard Default Table*

Extended Keypad	Keystroke
7001	Break
7002	Delete
7003	Pg Up
7004	End
7005	Pg Dn
7006	Pause
7007	Scroll Lock
7008	Backspace
7009	Tab
7010	Print Screen
7011	Insert
7012	Home
7013	Enter
7014	Escape
7015	Up Arrow
7016	Dn Arrow
7017	Left Arrow
7018	Right Arrow

Index

Numerics

123Scan2	10-1
2D bar codes	
aztec	9-81
aztec inverse	9-81
code 128 emulation	9-77
data matrix	9-78
data matrix inverse	9-78
maxicode	9-79
microPDF417	9-76
microQR	9-80
PDF417	9-76
QR code	9-79
QR inverse	9-80

A

accessories	1-5
interface cable	1-5
power supply	1-5
shielded interface cable	1-3
ADF	11-1
invalid rule	3-4
transmit error	3-4
advanced data formatting	3-4, 11-1
aiming	
orientation	2-7
aiming options	
hand-held decode aiming pattern	4-19, 4-20
aiming pattern	2-7
enabling	4-19, 4-20
orientation	2-8
ASCII values	
keyboard wedge	8-13
RS-232	6-19
USB	5-19

assembling the stand	2-5
----------------------	-----

B

bar codes	
Australia post	9-64
Australia post format	9-65
aztec	9-81
aztec inverse	9-81
beep after good decode	4-5
beeper tone	4-6
beeper volume	4-7
bookland EAN	9-10
bookland ISBN	9-11
buffering	9-35
cancel	D-2
Chinese 2 of 5	9-55
codabar	9-49
codabar CLSI editing	9-51
codabar lengths	9-49
codabar NOTIS editing	9-51
code 11	9-39
code 11 lengths	9-39
code 128	9-25
code 128 emulation	9-77
code 128 lengths	9-25
code 39	9-30
transmit buffer	9-36
code 39 check digit verification	9-33
code 39 full ASCII	9-34
code 39 lengths	9-32
code 39 transmit check digit	9-33
code 93	9-37
code 93 lengths	9-37
composite CC-A/B	9-73
composite CC-C	9-73
composite TLC-39	9-74

continuous bar code read	4-13	Korean 3 of 5	9-59
convert GS1 databar to UPC/EAN	9-72	low power mode	4-8
convert UPC-E to UPC-A	9-21	matrix 2 of 5	9-56
convert UPC-E1 to UPC-A	9-21	matrix 2 of 5 check digit	9-58
coupon report	9-23	matrix 2 of 5 lengths	9-57
data matrix	9-78	maxicode	9-79
data matrix inverse	9-78	microPDF417	9-76
decode mirror images	4-16	microQR	9-80
decode session timeout	4-14	mobile phone/display mode	4-17
disable all code types	9-7	MSI	9-52
discrete 2 of 5	9-46	MSI check digit algorithm	9-55
lengths	9-48	MSI check digits	9-54
EAN zero extend	9-22	MSI lengths	9-52
EAN-13/JAN-13	9-10	MSI transmit check digit	9-54
EAN-8/JAN-8	9-9	multicode mode	4-22, 4-23, 4-28, 4-29
flush macro buffer/abort macro PDF entry	9-86	multicode troubleshooting	4-30
FN1 substitution values	4-35	Netherlands KIX code	9-66
fuzzy 1D processing	4-15	numeric bar codes	D-2
GS1 databar	9-68	parameter scanning	4-5
GS1 databar expanded	9-71	PDF prioritization	4-18
GS1 databar limited	9-69	PDF prioritization timeout	4-18
GS1 databar limited security level	9-70	PDF417	9-76
GS1 databar-14	9-68	picklist modes	4-12
GS1-128	9-26	postal	9-61
hand-held decode aiming pattern	4-19, 4-20	prefix/suffix values	4-33
I 2 of 5 check digit verification	9-45	presentation mode field of view	4-21
I 2 of 5 convert to EAN-13	9-46	QR code	9-79
I 2 of 5 transmit check digit	9-45	QR inverse	9-80
IBM 468X/469X		RS-232	
convert unknown to code 39	7-5	baud rate	6-8
default parameters	7-3	beep on bel	6-16
ignore beep directive	7-5	check receive errors	6-11
ignore configuration directive	5-12, 7-6	data bits	6-10
port address	7-4	default table	6-3
illumination	4-22	hardware handshaking	6-11, 6-12
interleaved 2 of 5	9-42	host serial response time-out	6-15
convert to EAN-13	9-46	host types	6-6
lengths	9-43	intercharacter delay	6-17
inverse 1D	9-60	parity	6-9
ISBT 128	9-27	RTS line state	6-16
ISBT concatenation	9-28, 9-29	software handshaking	6-13, 6-14
ISBT concatenation redundancy	9-29	stop bit select	6-16
ISSN EAN	9-24	stop bits	6-10
Japan postal	9-63	samples	C-1
keyboard wedge		scan data options	4-34
alternate numeric keypad emulation	8-8	set defaults	4-4
caps lock override	8-9	supplementals	9-12
country keyboard types (country codes)	8-5	suppress power-up beeps	4-8
default table	8-3	symbolologies	
host types	8-4	default table	9-2
ignore unknown characters	8-7	time delay to low power mode	4-9
intra-keystroke delay	8-8	timeout between decodes, different symbols	4-15
keystroke delay	8-7	timeout between decodes, same symbol	4-14
simulated caps lock	8-9	transmit code ID character	4-32

- transmit matrix 2 of 5 check digit 9-58
 - transmit no read message 4-36
 - transmit UK postal check digit 9-63
 - transmit US postal check digit 9-62
 - trigger modes 4-11
 - UCC coupon extended code 9-22
 - UK postal 9-62
 - unique bar code reporting 4-13
 - UPC composite mode 9-74
 - UPC/EAN
 - coupon code 9-22
 - supp redundancy 9-15, 9-16
 - UPC/EAN/JAN
 - supplemental AIM ID format 9-16
 - supplemental redundancy 9-15
 - UPC-A 9-8
 - UPC-A preamble 9-18
 - UPC-A/E/E1 check digit 9-17, 9-18
 - UPC-E 9-8
 - UPC-E preamble 9-19
 - UPC-E1 9-9
 - UPU FICS postal 9-67
 - US planet 9-61
 - US postnet 9-61
 - USB
 - caps lock override 5-10
 - country keyboard types 5-7
 - default table 5-3
 - device type 5-5
 - ignore beep directive 5-12
 - keystroke delay 5-9
 - polling interval 5-16, 5-17
 - quick emulation 5-18
 - simulated caps lock 5-10
 - SNAPI handshaking 5-6
 - static CDC 5-15
 - unknown characters 5-11
 - USPS 4CB/One Code/Intelligent Mail 9-66
 - beeper
 - beep after good decode 4-5
 - definitions 2-2
 - duration 4-7
 - suppress power-up beeps 4-8
 - tone 4-6
 - volume 4-7
 - bullets xv
- C**
- cables
 - installing 1-3
 - interface 1-5
 - removing 1-4
 - shielded 1-3
 - signal descriptions 3-7
 - character sets
 - keyboard wedge 8-13
 - RS-232 6-19
 - USB 5-19
 - Chinese 2 of 5 bar codes 9-55
 - codabar bar codes
 - CLSI editing 9-51
 - codabar 9-49
 - lengths 9-49
 - NOTIS editing 9-51
 - code 11 bar codes
 - code 11 9-39
 - lengths 9-39
 - code 128 bar codes
 - code 128 9-25
 - GS1-128 9-26
 - ISBT 128 9-27
 - ISBT concatenation 9-28, 9-29
 - ISBT concatenation redundancy 9-29
 - lengths 9-25
 - code 128 emulation bar codes 9-77
 - code 39 bar codes
 - buffering 9-35
 - check digit verification 9-33
 - code 39 9-30
 - full ASCII 9-34
 - lengths 9-32
 - transmit check digit 9-33
 - code 93 bar codes
 - code 93 9-37
 - lengths 9-37
 - code ID character 4-32
 - code identifiers
 - AIM code IDs B-3
 - modifier characters B-4
 - Symbol B-1
 - composite bar codes
 - composite CC-A/B 9-73
 - composite CC-C 9-73
 - composite TLC-39 9-74
 - UPC composite mode 9-74
 - connecting
 - IBM 468X/469X interface 7-2
 - interface cable 1-3
 - keyboard wedge interface 8-2
 - power 1-4
 - RS-232 interface 6-2
 - USB interface 5-2
 - conventions
 - notational xv

D

data matrix bar codes	9-78
decode zones	2-9
default parameters	
IBM 468X/469X	7-3
keyboard wedge	8-3
RS-232	6-3
standard default table	A-1
symbolologies	9-2
USB	5-3
user preferences	4-2
digital scanner	
parts	2-1
discrete 2 of 5 bar codes	
discrete 2 of 5	9-46

E

error indications	
ADF	3-4
format	3-4
input	3-3
exposure options	
illumination	4-22
presentation mode field of view	4-21

G

GS1 DataBar	9-68
GS1 databar	
convert GS1 databar to UPC/EAN	9-72

H

host types	
keyboard wedge	8-4
RS-232	6-6

I

IBM 468X/469X	
connection	7-2
default parameters	7-3
parameters	7-4
illumination	4-22
intellistand	2-5, 2-6
interleaved 2 of 5 bar codes	
check digit verification	9-45
convert to EAN-13	9-46
transmit check digit	9-45

K

keyboard wedge	
connection	8-2
default parameters	8-3
parameters	8-4
Korean 3 of 5 bar codes	9-59

L

LED definitions	2-4
-----------------	-----

M

macro PDF	9-86
flush buffer/abort PDF entry	9-86
maintenance	3-1
matrix 2 of 5 bar codes	9-56
check digit	9-58
lengths	9-57
transmit check digit	9-58
maxicode bar codes	9-79
microPDF417 bar codes	9-76
Motorola Solutions support	xvi
MSI bar codes	
check digit algorithm	9-55
check digits	9-54
lengths	9-52
MSI	9-52
transmit check digit	9-54

N

notational conventions	xv
------------------------	----

P

parts	2-1
PDF417 bar codes	9-76
PDF prioritization	4-18
pinouts	
scanner signal descriptions	3-7
postal codes	9-61
Australia post	9-64
Australia post format	9-65
Japan postal	9-63
Netherlands KIX code	9-66
transmit UK postal check digit	9-63
transmit US postal check digit	9-62
UK postal	9-62
UPU FICS postal	9-67
US planet	9-61
US postnet	9-61
USPS 4CB/One Code/Intelligent Mail	9-66

power supply	1-5
connecting	1-4
presentation mode	2-5
presentation mode field of view	4-21

Q

QR code bar codes	9-79
quick start guide	1-5

R

RS-232	
connection	6-2
default parameters	6-3
parameters	6-4, 6-6

S

sample bar codes	C-1
scanning	
aiming	2-7
errors	4-2, 9-2
hand-held	2-5
hand-held mode	2-7
hands-free	2-5, 2-6
presentation mode	2-5
sequence example	4-2, 9-1
service information	.xvi
setup	
connecting a USB interface	5-2
connecting an RS-232 interface	6-2
connecting keyboard wedge interface	8-2
connecting power	1-4
connecting to an IBM 468X/469X host	7-2
installing interface cable	1-3
unpacking	1-2
shielded cable	1-3
signal descriptions	3-7
specifications	3-5
stand	
assembling	2-5
standard default parameters	A-1
support	.xvi
symbology default parameters	9-2

T

technical specifications	3-5
trigger	
hand-held mode	4-11
troubleshooting	3-2

U

unpacking	1-2
UPC/EAN bar codes	
bookland EAN	9-10
bookland ISBN	9-11
check digit	9-17, 9-18
convert UPC-E to UPC-A	9-21
convert UPC-E1 to UPC-A	9-21
coupon report	9-23
EAN zero extend	9-22
EAN-13/JAN-13	9-10
EAN-8/JAN-8	9-9
ISSN EAN	9-24
supplementals	9-12
UCC coupon extended code	9-22
UPC-A	9-8
UPC-A preamble	9-18
UPC-E	9-8
UPC-E preamble	9-19
UPC-E1	9-9
USB	
connection	5-2
default parameters	5-3
parameters	5-5
user preferences parameters	4-2

Glossary

A

Aperture. The opening in an optical system defined by a lens or baffle that establishes the field of view.

API. An interface by means of which one software component communicates with or controls another. Usually used to refer to services provided by one software component to another, usually via software interrupts or function calls

Application Programming Interface. See **API**.

ASCII. American Standard Code for Information Interchange. A 7 bit-plus-parity code representing 128 letters, numerals, punctuation marks and control characters. It is a standard data transmission code in the U.S.

Autodiscrimination. The ability of an interface controller to determine the code type of a scanned bar code. After this determination is made, the information content is decoded.

B

Bar. The dark element in a printed bar code symbol.

Bar Code. A pattern of variable-width bars and spaces which represents numeric or alphanumeric data in machine-readable form. The general format of a bar code symbol consists of a leading margin, start character, data or message character, check character (if any), stop character, and trailing margin. Within this framework, each recognizable symbology uses its own unique format. See **Symbology**.

Bar Code Density. The number of characters represented per unit of measurement (e.g., characters per inch).

Bar Height. The dimension of a bar measured perpendicular to the bar width.

Bar Width. Thickness of a bar measured from the edge closest to the symbol start character to the trailing edge of the same bar.

BIOS. Basic Input Output System. A collection of ROM-based code with a standard API used to interface with standard PC hardware.

Bit. Binary digit. One bit is the basic unit of binary information. Generally, eight consecutive bits compose one byte of data. The pattern of 0 and 1 values within the byte determines its meaning.

Bits per Second (bps). Bits transmitted or received.

Boot or Boot-up. The process a computer goes through when it starts. During boot-up, the computer can run self-diagnostic tests and configure hardware and software.

BOOTP. A protocol for remote booting of diskless devices. Assigns an IP address to a machine and may specify a boot file. The client sends a bootp request as a broadcast to the bootp server port (67) and the bootp server responds using the bootp client port (68). The bootp server must have a table of all devices, associated MAC addresses and IP addresses.

bps. See **Bits Per Second**.

Byte. On an addressable boundary, eight adjacent binary digits (0 and 1) combined in a pattern to represent a specific character or numeric value. Bits are numbered from the right, 0 through 7, with bit 0 the low-order bit. One byte in memory is used to store one ASCII character.

C

CDRH. Center for Devices and Radiological Health. A federal agency responsible for regulating laser product safety. This agency specifies various laser operation classes based on power output during operation.

CDRH Class 1. This is the lowest power CDRH laser classification. This class is considered intrinsically safe, even if all laser output were directed into the eye's pupil. There are no special operating procedures for this class.

CDRH Class 2. No additional software mechanisms are needed to conform to this limit. Laser operation in this class poses no danger for unintentional direct human exposure.

Character. A pattern of bars and spaces which either directly represents data or indicates a control function, such as a number, letter, punctuation mark, or communications control contained in a message.

Character Set. Those characters available for encoding in a particular bar code symbology.

Check Digit. A digit used to verify a correct symbol decode. The scanner inserts the decoded data into an arithmetic formula and checks that the resulting number matches the encoded check digit. Check digits are required for UPC but are optional for other symbologies. Using check digits decreases the chance of substitution errors when a symbol is decoded.

Codabar. A discrete self-checking code with a character set consisting of digits 0 to 9 and six additional characters: (- \$: / , +).

Code 128. A high density symbology which allows the controller to encode all 128 ASCII characters without adding extra symbol elements.

Code 3 of 9 (Code 39). A versatile and widely used alphanumeric bar code symbology with a set of 43 character types, including all uppercase letters, numerals from 0 to 9 and 7 special characters (- . / + % \$ and space). The code name is derived from the fact that 3 of 9 elements representing a character are wide, while the remaining 6 are narrow.

Code 93. An industrial symbology compatible with Code 39 but offering a full character ASCII set and a higher coding density than Code 39.

Code Length. Number of data characters in a bar code between the start and stop characters, not including those characters.

Cold Boot. A cold boot restarts the mobile computer and erases all user stored records and entries.

COM port. Communication port; ports are identified by number, e.g., COM1, COM2.

Continuous Code. A bar code or symbol in which all spaces within the symbol are parts of characters. There are no intercharacter gaps in a continuous code. The absence of gaps allows for greater information density.

Cradle. A cradle is used for charging the terminal battery and for communicating with a host computer, and provides a storage place for the terminal when not in use.

D

Dead Zone. An area within a scanner's field of view, in which specular reflection may prevent a successful decode.

Decode. To recognize a bar code symbology (e.g., UPC/EAN) and then analyze the content of the specific bar code scanned.

Decode Algorithm. A decoding scheme that converts pulse widths into data representation of the letters or numbers encoded within a bar code symbol.

Decryption. Decryption is the decoding and unscrambling of received encrypted data. Also see, **Encryption** and **Key**.

Depth of Field. The range between minimum and maximum distances at which a scanner can read a symbol with a certain minimum element width.

Discrete 2 of 5. A binary bar code symbology representing each character by a group of five bars, two of which are wide. The location of wide bars in the group determines which character is encoded; spaces are insignificant. Only numeric characters (0 to 9) and START/STOP characters may be encoded.

Discrete Code. A bar code or symbol in which the spaces between characters (intercharacter gaps) are not part of the code.

DRAM. Dynamic random access memory.

E

EAN. European Article Number. This European/International version of the UPC provides its own coding format and symbology standards. Element dimensions are specified metrically. EAN is used primarily in retail.

Element. Generic term for a bar or space.

Encoded Area. Total linear dimension occupied by all characters of a code pattern, including start/stop characters and data.

ENQ (RS-232). ENQ software handshaking is also supported for the data sent to the host.

ESD. Electro-Static Discharge

F

Flash Disk. An additional megabyte of non-volatile memory for storing application and configuration files.

Flash Memory. Flash memory is responsible for storing the system firmware and is non-volatile. If the system power is interrupted the data is not be lost.

FTP. See **File Transfer Protocol**.

H

Hard Reset. See **Cold Boot**.

Host Computer. A computer that serves other terminals in a network, providing such services as computation, database access, supervisory programs and network control.

Hz. Hertz; A unit of frequency equal to one cycle per second.

I

IDE. Intelligent drive electronics. Refers to the solid-state hard drive type.

IEC. International Electrotechnical Commission. This international agency regulates laser safety by specifying various laser operation classes based on power output during operation.

IEC60825-1 Class 1. This is the lowest power IEC laser classification. Conformity is ensured through a software restriction of 120 seconds of laser operation within any 1000 second window and an automatic laser shutdown if the scanner's oscillating mirror fails.

IEEE Address. See **MAC Address**.

Input/Output Ports. I/O ports are primarily dedicated to passing information into or out of the terminal's memory. Series 9000 mobile computers include Serial and USB ports.

Intercharacter Gap. The space between two adjacent bar code characters in a discrete code.

Interleaved 2 of 5. A binary bar code symbology representing character pairs in groups of five bars and five interleaved spaces. Interleaving provides for greater information density. The location of wide elements (bar/spaces) within each group determines which characters are encoded. This continuous code type uses no intercharacter spaces. Only numeric (0 to 9) and START/STOP characters may be encoded.

Interleaved Bar Code. A bar code in which characters are paired together, using bars to represent the first character and the intervening spaces to represent the second.

Interleaved 2 of 5. A binary bar code symbology representing character pairs in groups of five bars and five interleaved spaces. Interleaving provides for greater information density. The location of wide elements (bar/spaces) within each

group determines which characters are encoded. This continuous code type uses no intercharacter spaces. Only numeric (0 to 9) and START/STOP characters may be encoded.

I/O Ports. interface The connection between two devices, defined by common physical characteristics, signal characteristics, and signal meanings. Types of interfaces include RS-232 and PCMCIA.

IOCTL. Input/Output Control.

IP Address. (Internet Protocol address) The address of a computer attached to an IP network. Every client and server station must have a unique IP address. A 32-bit address used by a computer on a IP network. Client workstations have either a permanent address or one that is dynamically assigned to them each session. IP addresses are written as four sets of numbers separated by periods; for example, 204.171.64.2.

IPX/SPX. Internet Package Exchange/Sequential Packet Exchange. A communications protocol for Novell. IPX is Novell's Layer 3 protocol, similar to XNS and IP, and used in NetWare networks. SPX is Novell's version of the Xerox SPP protocol.

IS-95. Interim Standard 95. The EIA/TIA standard that governs the operation of CDMA cellular service. Versions include IS-95A and IS-95B. See CDMA.

K

Key. A key is the specific code used by the algorithm to encrypt or decrypt the data. Also see, **Encryption** and **Decrypting**.

L

LASER. Light Amplification by Stimulated Emission of Radiation. The laser is an intense light source. Light from a laser is all the same frequency, unlike the output of an incandescent bulb. Laser light is typically coherent and has a high energy density.

Laser Diode. A gallium-arsenide semiconductor type of laser connected to a power source to generate a laser beam. This laser type is a compact source of coherent light.

Laser Scanner. A type of bar code reader that uses a beam of laser light.

LCD. See **Liquid Crystal Display**.

LED Indicator. A semiconductor diode (LED - Light Emitting Diode) used as an indicator, often in digital displays. The semiconductor uses applied voltage to produce light of a certain frequency determined by the semiconductor's particular chemical composition.

Light Emitting Diode. See **LED**.

Liquid Crystal Display (LCD). A display that uses liquid crystal sealed between two glass plates. The crystals are excited by precise electrical charges, causing them to reflect light outside according to their bias. They use little electricity and react relatively quickly. They require external light to reflect their information to the user.

M

MIL. 1 mil = 1 thousandth of an inch.

Misread (Misdecode). A condition which occurs when the data output of a reader or interface controller does not agree with the data encoded within a bar code symbol.

N

Nominal. The exact (or ideal) intended value for a specified parameter. Tolerances are specified as positive and negative deviations from this value.

Nominal Size. Standard size for a bar code symbol. Most UPC/EAN codes are used over a range of magnifications (e.g., from 0.80 to 2.00 of nominal).

NVM. Non-Volatile Memory.

O

ODI. See **Open Data-Link Interface**.

Open Data-Link Interface (ODI). Novell's driver specification for an interface between network hardware and higher-level protocols. It supports multiple protocols on a single NIC (Network Interface Controller). It is capable of understanding and translating any network information or request sent by any other ODI-compatible protocol into something a NetWare client can understand and process.

Open System Authentication. Open System authentication is a null authentication algorithm.

P

PAN . Personal area network. Using Bluetooth wireless technology, PANs enable devices to communicate wirelessly. Generally, a wireless PAN consists of a dynamic group of less than 255 devices that communicate within about a 33-foot range. Only devices within this limited area typically participate in the network.

Parameter. A variable that can have different values assigned to it.

PC Card. A plug-in expansion card for laptop computers and other devices, also called a PCMCIA card. PC Cards are 85.6mm long x 54 mm wide, and have a 68 pin connector. There are several different kinds:

- Type I; 3.3 mm high; use - RAM or Flash RAM
- Type II; 5 mm high; use - modems, LAN adaptors
- Type III; 10.5 high; use - Hard Disks

PCMCIA. Personal Computer Memory Card Interface Association. See **PC Card**.

Percent Decode. The average probability that a single scan of a bar code would result in a successful decode. In a well-designed bar code scanning system, that probability should approach near 100%.

PING. (Packet Internet Groper) An Internet utility used to determine whether a particular IP address is online. It is used to test and debug a network by sending out a packet and waiting for a response.

Presentation Mode. Typically used when the digital scanner sits on a countertop or is mounted on a wall, in this mode, the digital scanner operates in continuous (constant-on) mode, where it automatically decodes a bar code presented in its field of view.

Print Contrast Signal (PCS). Measurement of the contrast (brightness difference) between the bars and spaces of a symbol. A minimum PCS value is needed for a bar code symbol to be scannable. $PCS = (RL - RD) / RL$, where RL is the reflectance factor of the background and RD the reflectance factor of the dark bars.

Programming Mode. The state in which a scanner is configured for parameter values. See **Scanning Mode**.

Q

Quiet Zone. A clear space, containing no dark marks, which precedes the start character of a bar code symbol and follows the stop character.

QWERTY. A standard keyboard commonly used on North American and some European PC keyboards. "QWERTY" refers to the arrangement of keys on the left side of the third row of keys.

R

RAM. Random Access Memory. Data in RAM can be accessed in random order, and quickly written and read.

Reflectance. Amount of light returned from an illuminated surface.

Resolution. The narrowest element dimension which is distinguished by a particular reading device or printed with a particular device or method.

RF. Radio Frequency.

ROM. Read-Only Memory. Data stored in ROM cannot be changed or removed.

Router. A device that connects networks and supports the required protocols for packet filtering. Routers are typically used to extend the range of cabling and to organize the topology of a network into subnets. See **Subnet**.

RS-232. An Electronic Industries Association (EIA) standard that defines the connector, connector pins, and signals used to transfer data serially from one device to another.

S

Scan Area. Area intended to contain a symbol.

Scanner. An electronic device used to scan bar code symbols and produce a digitized pattern that corresponds to the bars and spaces of the symbol. Its three main components are: 1) Light source (laser or photoelectric cell) - illuminates a bar code.; 2) Photodetector - registers the difference in reflected light (more light reflected from spaces); 3) Signal conditioning circuit - transforms optical detector output into a digitized bar pattern.

Scanning Mode. The scanner is energized, programmed and ready to read a bar code.

Scanning Sequence. A method of programming or configuring parameters for a bar code reading system by scanning bar code menus.

SDK. Software Development Kit

Self-Checking Code. A symbology that uses a checking algorithm to detect encoding errors within the characters of a bar code symbol.

Shared Key. Shared Key authentication is an algorithm where both the AP and the MU share an authentication key.

SHIP. Symbol Host Interface Program.

SID. System Identification code. An identifier issued by the FCC for each market. It is also broadcast by the cellular carriers to allow cellular devices to distinguish between the home and roaming service.

Soft Reset. See **Warm Boot**.

Space. The lighter element of a bar code formed by the background between bars.

Specular Reflection. The mirror-like direct reflection of light from a surface, which can cause difficulty decoding a bar code.

Standard Trigger Mode. The digital scanner uses this mode when lifted off the counter or removed from the wall mount. In this mode, aim the digital scanner at a bar code and pull the trigger to decode.

Start/Stop Character. A pattern of bars and spaces that provides the scanner with start and stop reading instructions and scanning direction. The start and stop characters are normally to the left and right margins of a horizontal code.

STEP. Symbol Terminal Enabler Program.

Subnet. A subset of nodes on a network that are serviced by the same router. See **Router**.

Subnet Mask. A 32-bit number used to separate the network and host sections of an IP address. A custom subnet mask subdivides an IP network into smaller subsections. The mask is a binary pattern that is matched up with the IP address to turn part of the host ID address field into a field for subnets. Default is often 255.255.255.0.

Substrate. A foundation material on which a substance or image is placed.

SVTP. Symbol Virtual Terminal Program.

Symbol. A scannable unit that encodes data within the conventions of a certain symbology, usually including start/stop characters, quiet zones, data characters and check characters.

Symbol Aspect Ratio. The ratio of symbol height to symbol width.

Symbol Height. The distance between the outside edges of the quiet zones of the first row and the last row.

Symbol Length. Length of symbol measured from the beginning of the quiet zone (margin) adjacent to the start character to the end of the quiet zone (margin) adjacent to a stop character.

Symbology. The structural rules and conventions for representing data within a particular bar code type (e.g. UPC/EAN, Code 39, PDF417, etc.).

T

TCP/IP. (Transmission Control Protocol/Internet Protocol) A communications protocol used to internetwork dissimilar systems. This standard is the protocol of the Internet and has become the global standard for communications. TCP provides transport functions, which ensures that the total amount of bytes sent is received correctly at the other end. UDP is an alternate transport that does not guarantee delivery. It is widely used for real-time voice and video transmissions where erroneous packets are not retransmitted. IP provides the routing mechanism. TCP/IP is a routable protocol, which means that all messages contain not only the address of the destination station, but the address of a destination network. This allows TCP/IP messages to be sent to multiple networks within an organization or around the world, hence its use in the worldwide Internet. Every client and server in a TCP/IP network requires an IP address, which is either permanently assigned or dynamically assigned at startup.

Telnet. A terminal emulation protocol commonly used on the Internet and TCP/IP-based networks. It allows a user at a terminal or computer to log onto a remote device and run a program.

Terminal Emulation. A "terminal emulation" emulates a character-based mainframe session on a remote non-mainframe terminal, including all display features, commands and function keys. The VC5000 Series supports Terminal Emulations in 3270, 5250 and VT220.

Terminate and Stay Resident (TSR). A program under DOS that ends its foreground execution to remain resident in memory to service hardware/software interrupts, providing background operation. It remains in memory and may provide services on behalf of other DOS programs.

TFTP. (Trivial File Transfer Protocol) A version of the TCP/IP FTP (File Transfer Protocol) protocol that has no directory or password capability. It is the protocol used for upgrading firmware, downloading software and remote booting of diskless devices.

Tolerance. Allowable deviation from the nominal bar or space width.

Transmission Control Protocol/Internet Protocol. See **TCP/IP**.

Trivial File Transfer Protocol. See **TFTP**.

TSR. See **Terminate and Stay Resident**.

U

UDP. User Datagram Protocol. A protocol within the IP protocol suite that is used in place of TCP when a reliable delivery is not required. For example, UDP is used for real-time audio and video traffic where lost packets are simply ignored, because there is no time to retransmit. If UDP is used and a reliable delivery is required, packet sequence checking and error notification must be written into the applications.

UPC. Universal Product Code. A relatively complex numeric symbology. Each character consists of two bars and two spaces, each of which is any of four widths. The standard symbology for retail food packages in the United States.

V

Visible Laser Diode (VLD). A solid state device which produces visible laser light.

W

Warm Boot. A warm boot restarts the mobile computer by closing all running programs. All data that is not saved to flash memory is lost.

Tell Us What You Think...

We'd like to know what you think about this Manual. Please take a moment to fill out this questionnaire and fax this form to: (631) 627-7184, or mail to:

Motorola Solutions, Inc.
One Motorola Plaza M/S B-10
Holtsville, NY 11742-1300
Attention: Advanced Data Capture
Technical Publications Manager



Important If you need product support, please call the appropriate customer support number provided. Unfortunately, we cannot provide customer support at the fax number above.

Manual Title: _____
(please include revision level)

How familiar were you with this product before using this manual?

- Very familiar Slightly familiar Not at all familiar

Did this manual meet your needs? If not, please explain.

What topics need to be added to the index, if applicable?

What topics do you feel need to be better discussed? Please be specific.

What can we do to further improve our manuals?



MOTOROLA

Motorola Solutions, Inc.
One Motorola Plaza
Holtsville, New York 11742, USA
1-800-927-9626
<http://www.motorolasolutions.com>

MOTOROLA, MOTO, MOTOROLA SOLUTIONS and the Stylized M Logo are trademarks or registered trademarks of Motorola Trademark Holding, LLC and are used under license. All other trademarks are the property of their respective owners.
© 2011 Motorola Solutions, Inc. All rights reserved.



72E-139232-02 Revision A - April 2011