

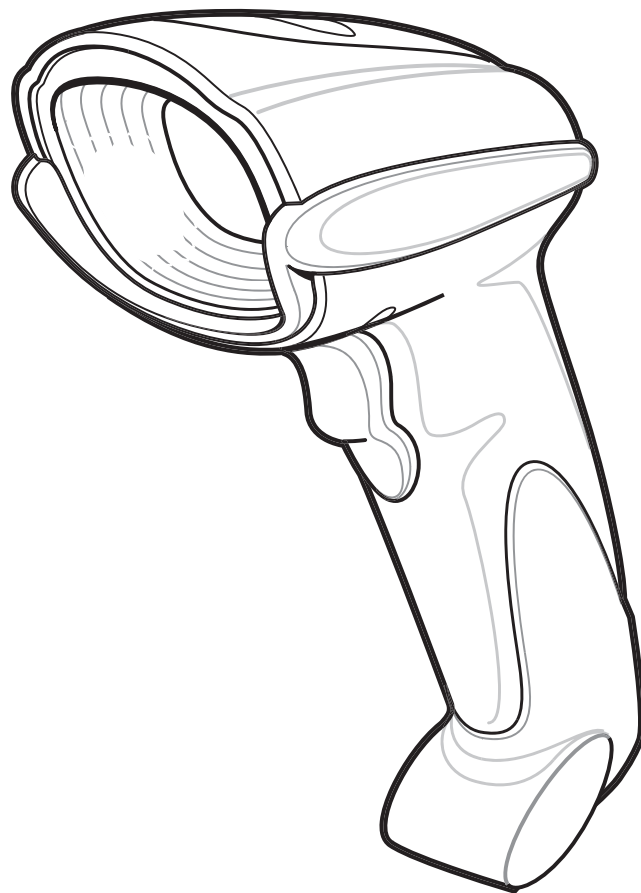

Symbol DS6707 Digital Imager Scanner

Product Reference Guide



***Symbol DS6707 Digital Imager Scanner
Product Reference Guide***

72E-83978-06

Revision A

May 2009

© 2007-2009 by Motorola, Inc. All rights reserved.

No part of this publication may be reproduced or used in any form, or by any electrical or mechanical means, without permission in writing from Motorola. This includes electronic or mechanical means, such as photocopying, recording, or information storage and retrieval systems. The material in this manual is subject to change without notice.

The software is provided strictly on an “as is” basis. All software, including firmware, furnished to the user is on a licensed basis. Motorola grants to the user a non-transferable and non-exclusive license to use each software or firmware program delivered hereunder (licensed program). Except as noted below, such license may not be assigned, sublicensed, or otherwise transferred by the user without prior written consent of Motorola. No right to copy a licensed program in whole or in part is granted, except as permitted under copyright law. The user shall not modify, merge, or incorporate any form or portion of a licensed program with other program material, create a derivative work from a licensed program, or use a licensed program in a network without written permission from Motorola. The user agrees to maintain Motorola’s copyright notice on the licensed programs delivered hereunder, and to include the same on any authorized copies it makes, in whole or in part. The user agrees not to decompile, disassemble, decode, or reverse engineer any licensed program delivered to the user or any portion thereof.

Motorola reserves the right to make changes to any software or product to improve reliability, function, or design.

Motorola does not assume any product liability arising out of, or in connection with, the application or use of any product, circuit, or application described herein.

No license is granted, either expressly or by implication, estoppel, or otherwise under any Motorola, Inc., intellectual property rights. An implied license only exists for equipment, circuits, and subsystems contained in Motorola products.

MOTOROLA and the Stylized M Logo and Symbol and the Symbol logo are registered in the US Patent & Trademark Office. Bluetooth is a registered trademark of Bluetooth SIG. Microsoft, Windows and ActiveSync are either registered trademarks or trademarks of Microsoft Corporation. All other product or service names are the property of their respective owners.

Motorola, Inc.
One Motorola Plaza
Holtsville, New York 11742-1300
<http://www.motorola.com/enterprisemobility>

Patents

This product is covered by one or more of the patents listed on the website:
<http://www.motorola.com/enterprisemobility/patents>

Revision History

Changes to the original manual are listed below:

Change	Date	Description
-01 Rev A	8/2006	Initial Release.
-02 Rev A	4/2007	Updated service information, updated operating temperature and drop specifications, added Host Trigger Mode option, added new UPC/EAN supplemental options, changed RSS references to GS1 DataBar, added following parameters: Illumination Bank Control, Fixed Exposure, Fixed Gain, Gain/Exposure Priority for Snapshot Mode, Image Brightness, JPEG Target File Size, Image Enhancement, Bookland ISBN format, 4State Postal, Inverse 1D, Data Matrix Inverse, Micro QR, QR Inverse, Aztec, Aztec Inverse
-03 Rev A	8/2007	Updated decode zone/range information
-04 Rev A	8/2008	Added DP and HD model information, added Fuzzy 1D, Decode Mirror Images, Low Light Enhancement, and Presentation Mode Field of View parameters, updated Signature Capture Width and Height options, added Code 128 Lengths and Post US4, changed code type name from UCC/EAN-128 to GS1-128
-05 Rev A	10/2008	Updated wall mount template, added separate dimensions and weight specifications for the Symbol DS6707-DP model, added custom defaults options, added specific string search and new move cursor options in ADF chapter
-06 Rev A	5/2009	Added ISSN EAN, Matrix 2 of 5, and Chinese 2 of 5 code types, added ISBT concatenation parameters.

Table of Contents

About This Guide

Introduction	xv
Configurations	xv
Chapter Descriptions	xv
Notational Conventions	xvi
Related Documents	xvii
Service Information	xvii

Chapter 1: Getting Started

Introduction	1-1
Supported Interfaces	1-2
Unpacking	1-2
Setting Up the Digital Imager Scanner	1-3
Installing the Interface Cable	1-3
Removing the Interface Cable	1-3
Connecting Power (if required)	1-4
Configuring the Digital Imager Scanner	1-4
Mounting the Digital Imager Scanner	1-4
Desk Mount	1-4
Wall Mount	1-5

Chapter 2: Scanning

Introduction	2-1
Beeper Definitions	2-2
LED Definitions	2-4
Scanning in Hand-Held Mode	2-4
Scanning with the Digital Imager Scanner	2-4
Aiming	2-6
Scanning in Presentation Mode	2-7
Decode Zones	2-8
Symbol DS6707-SR Standard Range Digital Imager Scanner - 1D Bar Codes	2-8
Symbol DS6707-SR Standard Range Digital Imager Scanner - 2D Bar Codes	2-9

Symbol DS6707-DC Document Capture Digital Imager Scanner - 1D Bar Codes .	2-10
Symbol DS6707-DC Document Capture Digital Imager Scanner - 2D Bar Codes .	2-11
Symbol DS6707-DP Direct Part Mark Digital Imager Scanner - 1D and PDF417 Bar Codes	2-12
Symbol DS6707-DP Direct Part Mark Digital Imager Scanner - 2D Bar Codes	2-13
Symbol DS6707-HD High Density Digital Imager Scanner - 1D and PDF417 Bar Codes	2-14
Symbol DS6707-HD High Density Digital Imager Scanner - 2D Bar Codes	2-15

Chapter 3: Maintenance & Technical Specifications

Introduction	3-1
Maintenance	3-1
Troubleshooting	3-2
Technical Specifications	3-4
Digital Imager Scanner Signal Descriptions	3-8

Chapter 4: User Preferences & Miscellaneous Digital Imager Scanner Options

Introduction	4-1
Scanning Sequence Examples	4-2
Errors While Scanning	4-2
User Preferences and Miscellaneous Options - Parameter Defaults	4-2
User Preferences	4-4
Set Default Parameter	4-4
Parameter Scanning	4-5
Beeper Tone	4-5
Beeper Volume	4-6
Power Mode	4-6
Time Delay to Low Power Mode	4-7
Trigger Mode	4-8
Picklist Mode	4-9
Decode Session Timeout	4-10
Timeout Between Decodes, Same Symbol	4-10
Decoding Illumination	4-11
DP Illumination	4-12
Decode Aiming Pattern	4-13
Fuzzy 1D Processing	4-13
Decode Mirror Images (Data Matrix Only)	4-14
Miscellaneous Scanner Parameters	4-15
Transmit Code ID Character	4-15
Prefix/Suffix Values	4-16
Scan Data Transmission Format	4-17
FN1 Substitution Values	4-18
Transmit "No Read" Message	4-19

Chapter 5: Imaging Preferences

Introduction	5-1
Scanning Sequence Examples	5-2
Errors While Scanning	5-2
Imaging Preferences Parameter Defaults	5-2
Imaging Preferences	5-4
Operational Modes	5-4
Low Light Enhancement	5-5
Presentation Mode Field of View	5-5
Image Capture Autoexposure	5-6
Image Capture Illumination	5-6
Illumination Bank Control	5-7
Fixed Exposure	5-8
Fixed Gain	5-8
Gain/Exposure Priority for Snapshot Mode	5-9
Snapshot Mode Timeout	5-10
Snapshot Aiming Pattern	5-10
Image Cropping	5-11
Crop to Pixel Addresses	5-12
Image Size (Number of Pixels)	5-13
Image Brightness (Target White)	5-14
JPEG Image Options	5-14
JPEG Target File Size	5-15
JPEG Quality and Size Value	5-15
Image Enhancement	5-16
Image File Format Selector	5-17
Bits Per Pixel	5-18
Signature Capture	5-19
Signature Capture File Format Selector	5-20
Signature Capture Bits Per Pixel	5-21
Signature Capture Width	5-22
Signature Capture Height	5-22
Signature Capture JPEG Quality	5-22
Video View Finder	5-23
Target Video Frame Size	5-23
Video View Finder Image Size	5-24

Chapter 6: SSI Interface

Introduction	6-1
Connecting Using Simple Serial Interface	6-2
Simple Serial Interface Default Parameters	6-3
SSI Host Parameters	6-4
Baud Rate	6-4
Parity	6-6
Check Parity	6-7
Software Handshaking	6-7
Host RTS Line State	6-8
Decode Data Packet Format	6-8
Stop Bit Select	6-9

Host Serial Response Time-out	6-10
Host Character Time-out	6-11
Multipacket Option	6-12
Interpacket Delay	6-13
Event Reporting	6-14
Decode Event	6-14
Boot Up Event	6-15
Parameter Event	6-15

Chapter 7: USB Interface

Introduction	7-1
Connecting a USB Interface	7-2
USB Parameter Defaults	7-3
USB Host Parameters	7-4
USB Device Type	7-4
Symbol Native API (SNAPI) Status Handshaking	7-5
USB Country Keyboard Types (Country Codes)	7-6
USB Keystroke Delay	7-8
USB CAPS Lock Override	7-8
USB Ignore Unknown Characters	7-9
Emulate Keypad	7-9
Emulate Keypad with Leading Zero	7-10
USB Keyboard FN 1 Substitution	7-10
Function Key Mapping	7-11
Simulated Caps Lock	7-11
Convert Case	7-12
ASCII Character Set for USB	7-13

Chapter 8: RS-232 Interface

Introduction	8-1
Connecting an RS-232 Interface	8-2
RS-232 Parameter Defaults	8-3
RS-232 Host Parameters	8-4
RS-232 Host Types	8-6
Baud Rate	8-7
Parity	8-9
Stop Bit Select	8-10
Data Bits	8-10
Check Receive Errors	8-11
Hardware Handshaking	8-11
Software Handshaking	8-13
Host Serial Response Time-out	8-15
RTS Line State	8-16
Beep on <BEL>	8-16
Intercharacter Delay	8-17
Nixdorf Beep/LED Options	8-18
Ignore Unknown Characters	8-18
ASCII Character Set for RS-232	8-19

Chapter 9: 123Scan

Introduction	9-1
123Scan Parameter	9-1

Chapter 10: Symbolologies

Introduction	10-1
Scanning Sequence Examples	10-1
Errors While Scanning	10-2
Symbology Parameter Defaults	10-2
UPC/EAN	10-7
Enable/Disable UPC-A	10-7
Enable/Disable UPC-E	10-7
Enable/Disable UPC-E1	10-8
Enable/Disable EAN-8/JAN-8	10-8
Enable/Disable EAN-13/JAN-13	10-9
Enable/Disable Bookland EAN	10-9
Decode UPC/EAN/JAN Supplementals	10-10
User-Programmable Supplementals	10-13
UPC/EAN/JAN Supplemental Redundancy	10-14
Transmit UPC-A Check Digit	10-14
Transmit UPC-E Check Digit	10-15
Transmit UPC-E1 Check Digit	10-15
UPC-E1 Preamble	10-18
Convert UPC-E1 to UPC-A	10-19
UCC Coupon Extended Code	10-22
ISSN EAN	10-22
Code 128	10-23
Enable/Disable Code 128	10-23
Set Lengths for Code 128	10-23
Enable/Disable GS1-128 (formerly UCC/EAN-128)	10-25
Enable/Disable ISBT 128	10-25
ISBT Concatenation	10-26
Check ISBT Table	10-27
ISBT Concatenation Redundancy	10-27
Code 39	10-28
Enable/Disable Code 39	10-28
Enable/Disable Trioptic Code 39	10-28
Convert Code 39 to Code 32	10-29
Code 32 Prefix	10-29
Set Lengths for Code 39	10-30
Code 39 Check Digit Verification	10-31
Transmit Code 39 Check Digit	10-32
Code 39 Full ASCII Conversion	10-32
Code 39 Buffering (Scan & Store)	10-33
Code 93	10-36
Enable/Disable Code 93	10-36
Set Lengths for Code 93	10-36
Code 11	10-38
Code 11	10-38

Set Lengths for Code 11	10-38
Code 11 Check Digit Verification	10-40
Transmit Code 11 Check Digits	10-41
Interleaved 2 of 5 (ITF)	10-42
Enable/Disable Interleaved 2 of 5	10-42
Set Lengths for Interleaved 2 of 5	10-42
I 2 of 5 Check Digit Verification	10-44
Transmit I 2 of 5 Check Digit	10-44
Convert I 2 of 5 to EAN-13	10-45
Discrete 2 of 5 (DTF)	10-46
Enable/Disable Discrete 2 of 5	10-46
Set Lengths for Discrete 2 of 5	10-46
Codabar (NW - 7)	10-48
Enable/Disable Codabar	10-48
Set Lengths for Codabar	10-48
CLSI Editing	10-50
NOTIS Editing	10-50
MSI	10-51
Enable/Disable MSI	10-51
Set Lengths for MSI	10-51
MSI Check Digits	10-52
Transmit MSI Check Digit(s)	10-53
MSI Check Digit Algorithm	10-53
Chinese 2 of 5	10-54
Enable/Disable Chinese 2 of 5	10-54
Matrix 2 of 5	10-55
Enable/Disable Matrix 2 of 5	10-55
Set Lengths for Matrix 2 of 5	10-56
Matrix 2 of 5 Redundancy	10-57
Matrix 2 of 5 Check Digit	10-57
Transmit Matrix 2 of 5 Check Digit	10-58
Inverse 1D	10-59
Postal Codes	10-60
US Postnet	10-60
US Planet	10-60
Transmit US Postal Check Digit	10-61
UK Postal	10-61
Transmit UK Postal Check Digit	10-62
Japan Postal	10-62
Australian Postal	10-63
Netherlands KIX Code	10-63
USPS 4CB/One Code/Intelligent Mail	10-64
UPU FICS Postal	10-64
GS1 DataBar	10-65
GS1 DataBar-14	10-65
GS1 DataBar Limited	10-65
GS1 DataBar Expanded	10-66
Convert GS1 DataBar to UPC/EAN	10-66
Composite	10-67
Composite CC-C	10-67

Composite CC-A/B	10-67
Composite TLC-39	10-68
UPC Composite Mode	10-69
Composite Beep Mode	10-70
GS1-128 Emulation Mode for UCC/EAN Composite Codes	10-70
2D Symbolologies	10-71
Enable/Disable PDF417	10-71
Enable/Disable MicroPDF417	10-71
Code 128 Emulation	10-72
Data Matrix	10-73
Data Matrix Inverse	10-74
Maxicode	10-75
QR Code	10-75
QR Inverse	10-76
MicroQR	10-77
Aztec	10-77
Aztec Inverse	10-78
Redundancy Level	10-79
Redundancy Level 1	10-79
Redundancy Level 2	10-79
Redundancy Level 3	10-79
Redundancy Level 4	10-80
Security Level	10-81
Intercharacter Gap Size	10-82
Report Version	10-82
Macro PDF Features	10-83
Flush Macro Buffer	10-83
Abort Macro PDF Entry	10-83

Chapter 11: Advanced Data Formatting

Introduction	11-1
Rules: Criteria Linked to Actions	11-1
Using ADF Bar Codes	11-2
ADF Bar Code Menu Example	11-2
Rule 1: The Code 128 Scanning Rule	11-3
Rule 2: The UPC Scanning Rule	11-3
Alternate Rule Sets	11-3
Rules Hierarchy (in Bar Codes)	11-4
Default Rules	11-5
ADF Bar Codes	11-5
Special Commands	11-8
Pause Duration	11-8
Begin New Rule	11-8
Save Rule	11-8
Erase	11-9
Quit Entering Rules	11-9
Disable Rule Set	11-10
Criteria	11-11
Code Types	11-11

Code Lengths	11-18
Message Containing A Specific Data String	11-22
Actions	11-27
Send Data	11-27
Setup Field(s)	11-30
Modify Data	11-37
Pad Data with Spaces	11-38
Pad Data with Zeros	11-42
Beeps	11-47
Send Keystroke (Control Characters and Keyboard Characters)	11-47
Send Right Control Key	11-83
Send Graphic User Interface (GUI) Characters	11-84
Turn On/Off Rule Sets	11-89
Alphanumeric Keyboard	11-91

Appendix A: Standard Default Parameters

Appendix B: Programming Reference

Symbol Code Identifiers	B-1
AIM Code Identifiers	B-3

Appendix C: Sample Bar Codes

Code 39	C-1
UPC/EAN	C-1
UPC-A, 100%	C-1
EAN-13, 100%	C-2
Code 128	C-2
Interleaved 2 of 5	C-2
GS1 DataBar-14	C-3
PDF417	C-3
Data Matrix	C-3
Maxicode	C-4
QR Code	C-4
US Postnet	C-4
UK Postal	C-5

Appendix D: Numeric Bar Codes

Numeric Bar Codes	D-1
Cancel	D-2

Appendix E: ASCII Character Sets

Glossary

Index

Tell Us What You Think...

About This Guide

Introduction

The *Symbol DS6707 Digital Imager Scanner Product Reference Guide* provides general instructions for setting up, operating, maintaining, and troubleshooting the Symbol DS6707 digital imager scanner.

Configurations

This guide includes the following digital imager scanner configurations:

- Symbol DS6707-SR: Standard Range digital imager scanner for point of sale scanning.
- Symbol DS6707-DC: Document Capture digital imager scanner for 8 1/2 in. by 11 in. imaging.
- Symbol DS6707-DP: Direct Part Mark digital imager scanner for DPM scanning.
- Symbol DS6707-HD: High Density digital imager scanner for high-density 1D and 2D bar codes.

Chapter Descriptions

Topics included in this guide are as follows:

- [Chapter 1, Getting Started](#) provides a product overview, unpacking instructions, and cable connection information.
- [Chapter 2, Scanning](#) describes parts of the digital imager scanner, beeper and LED definitions, and how to use the scanner in hand-held and presentation (hands-free) modes.
- [Chapter 3, Maintenance & Technical Specifications](#) provides information on how to care for the digital imager scanner, troubleshooting, and technical specifications.
- [Chapter 4, User Preferences & Miscellaneous Digital Imager Scanner Options](#) provides frequently used features to customize how data transmits to the host, and programming bar codes for selecting these features for the digital imager scanner.
- [Chapter 5, Imaging Preferences](#) provides programming bar codes for selecting imaging features.

- [Chapter 6, SSI Interface](#) describes how to set up the digital imager scanner with a Simple Serial Interface (SSI) host. When using SSI, program the digital imager scanner via bar code menu or SSI host commands.
- [Chapter 7, USB Interface](#) describes how to set up the digital imager scanner with a USB host.
- [Chapter 8, RS-232 Interface](#) describes how to set up the digital imager scanner with an RS-232 host, such as point-of-sale devices, host computers, or other devices with an available RS-232 port.
- [Chapter 9, 123Scan](#) describes the 123Scan PC-based scanner configuration tool, and provides the bar code to scan to communicate with the 123Scan program.
- [Chapter 10, Symbologies](#) describes all symbology features and provides programming bar codes for selecting these features for the digital imager scanner.
- [Chapter 11, Advanced Data Formatting](#) (ADF) describes how to customize scanned data before transmitting to the host.
- [Appendix A, Standard Default Parameters](#) provides a table of all host devices and miscellaneous scanner defaults.
- [Appendix B, Programming Reference](#) provides a table of AIM code identifiers, ASCII character conversions, and keyboard maps.
- [Appendix C, Sample Bar Codes](#) includes sample bar codes of various code types.
- [Appendix D, Numeric Bar Codes](#) includes the numeric bar codes to scan for parameters requiring specific numeric values.
- [Appendix E, ASCII Character Sets](#) provides ASCII character value tables.

Notational Conventions

The following conventions are used in this document:

- *Italics* are used to highlight the following:
 - Chapters and sections in this and related documents
 - Dialog box, window and screen names
 - Drop-down list and list box names
 - Check box and radio button names
- **Bold** text is used to highlight the following:
 - Key names on a keypad
 - Button names on a screen.
- bullets (•) indicate:
 - Action items
 - Lists of alternatives
 - Lists of required steps that are not necessarily sequential
- Sequential lists (e.g., those that describe step-by-step procedures) appear as numbered lists.

- Throughout the programming bar code menus, asterisks (*) are used to denote default parameter settings.

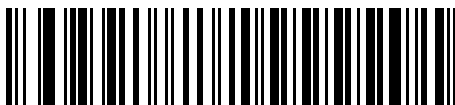

* Indicates Default — * Baud Rate 9600 — Feature/Option

Related Documents

The *Symbol DS6707 Digital Imager Scanner Quick Start Guide*, p/n 72-83972-xx, provides general information for getting started with the Symbol DS6707 digital imager scanner, and includes basic set up and operation instructions.

For the latest version of this guide and all guides, go to: <http://www.motorola.com/enterprisemobility/manuals>.

Service Information

If you have a problem with your equipment, contact Motorola Enterprise Mobility support for your region. Contact information is available at: <http://www.motorola.com/enterprisemobility/contactsupport>.

When contacting Enterprise Mobility support, please have the following information available:

- Serial number of the unit
- Model number or product name
- Software type and version number

Motorola responds to calls by e-mail, telephone or fax within the time limits set forth in service agreements.

If your problem cannot be solved by Motorola Enterprise Mobility Support, you may need to return your equipment for servicing and will be given specific directions. Motorola is not responsible for any damages incurred during shipment if the approved shipping container is not used. Shipping the units improperly can possibly void the warranty.

If you purchased your Enterprise Mobility business product from a Motorola business partner, please contact that business partner for support.

Chapter 1 Getting Started

Introduction

The Symbol DS6707 digital imager scanner combines superior 1D and 2D omnidirectional bar code scanning and sub-second image capture and transfer to provide the best value in a digital imager scanner. Whether in hand-held mode or presentation (hands-free) mode in a stand, the digital imager scanner ensures comfort and ease of use for extended periods of time.

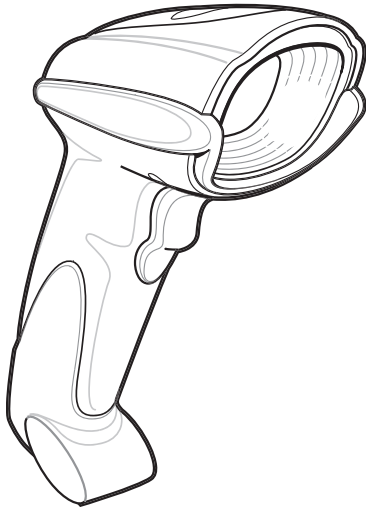

Figure 1-1 *Symbol DS6707 Digital Imager Scanner*

Supported Interfaces

The Symbol DS6707 digital imager scanner supports:

- Simple Serial Interface (SSI) connection to a host. When using SSI, program the digital imager scanner via bar code menu or SSI host commands.
- Standard RS-232 connection to a host. Scan bar code menus to set up communication between the digital imager scanner and the host.
- USB connection to a host. The digital imager scanner autodetects a USB host and defaults to the HID keyboard interface type. Select other USB interface types by scanning programming bar code menus. This interface supports the following international keyboards (for Windows® environment): North America, German, French, French Canadian, Spanish, Italian, Swedish, UK English, Portuguese-Brazilian, and Japanese.
- Configuration via 123Scan.

Unpacking

Remove the digital imager scanner from its packing and inspect it for damage. If the scanner was damaged in transit, contact Motorola Enterprise Mobility Support. See [page xvii](#) for contact information. **KEEP THE PACKING.** It is the approved shipping container; use this to return the equipment for servicing.

Setting Up the Digital Imager Scanner

Installing the Interface Cable

1. Plug the interface cable modular connector into the cable interface port on the bottom of the scanner handle. See [Figure 1-2](#).
2. Gently tug the cable to ensure the connector is properly secured.
3. Connect the other end of the interface cable to the host (see the specific host chapter for information on host connections).

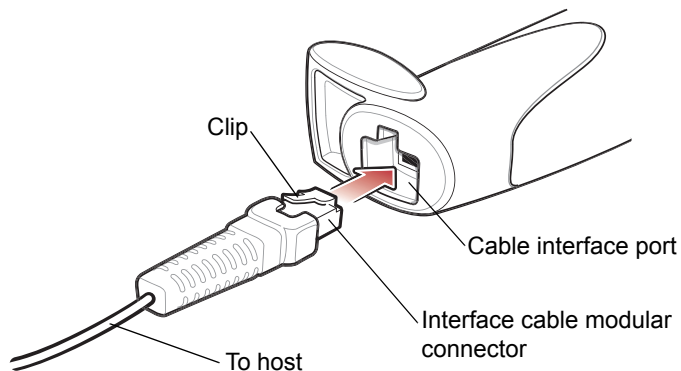

Figure 1-2 *Installing the Cable*

- ✓ **NOTE** Different hosts require different cables. The connectors illustrated in each host chapter are examples only. Connectors vary from those illustrated, but the steps to connect the digital imager scanner are the same.

Removing the Interface Cable

1. Using the tip of a screwdriver, depress the cable's modular connector clip.

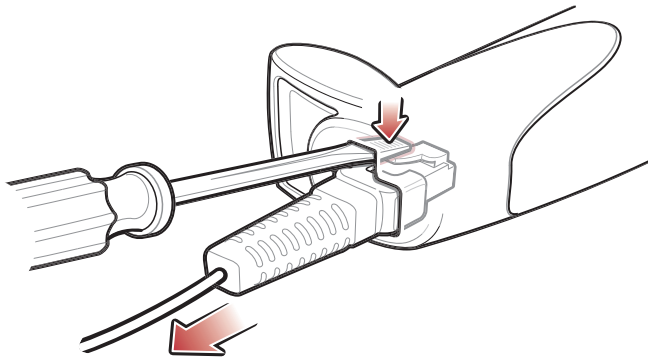

Figure 1-3 *Removing the Cable*

2. Carefully slide out the cable.
3. Follow the steps for [Installing the Interface Cable](#) to connect a new cable.

Connecting Power (if required)

If the host does not provide power to the digital imager scanner, connect an external power supply:

1. Connect the interface cable to the bottom of the digital imager scanner, as described in [Installing the Interface Cable on page 1-3](#).
2. Connect the other end of the interface cable to the host (refer to the host manual to locate the correct port).
3. Plug the power supply into the power jack on the interface cable. Plug the other end of the power supply into an AC outlet.

Configuring the Digital Imager Scanner

To configure the digital imager scanner, use the bar codes in this manual, or the 123Scan configuration program.

See [Chapter 4, User Preferences & Miscellaneous Digital Imager Scanner Options](#) and [Chapter 5, Imaging Preferences](#) for information about programming the digital imager scanner using bar code menus. Also see each host-specific chapter to set up connection to a specific host type.

See [Chapter 9, 123Scan](#) to configure the digital imager scanner using this configuration program. The program includes a help file.

Mounting the Digital Imager Scanner

Desk Mount

Use the optional desk mount for convenient and protective placement of the digital imager scanner on a flat surface. Simply place the mount on the surface. The rubber feet hold the mount securely in place when inserting and removing the digital imager scanner.

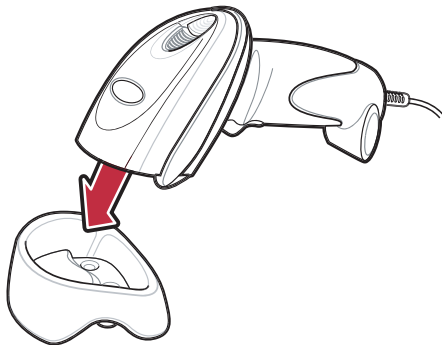

Figure 1-4 *Inserting the Digital Imager Scanner in the Desk Mount*

Alternatively, secure the desk mount to a desk surface by inserting two screws* appropriate for the mounting surface through the screw holes of the desk mount, and into the surface. Screw the desk mount onto the surface with or without the rubber feet.

*The recommended screws are two #6 screws (5/8" long).

Wall Mount

To use the optional wall mount to mount the digital imager scanner on a wall, place the mount in the desired location on the wall and secure by inserting two screws* appropriate for the mounting surface through the screw holes on the mount, and into the surface. Insert the digital imager scanner into the mount as shown.

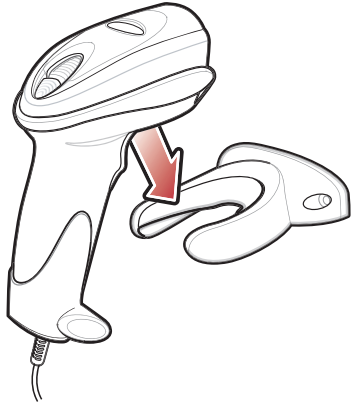

Figure 1-5 *Securing the Wall Mount*

*The recommended screws are two #6 screws (1" long) and two #6 washers.

For convenience, print this page and use the template below for mounting hole locations.

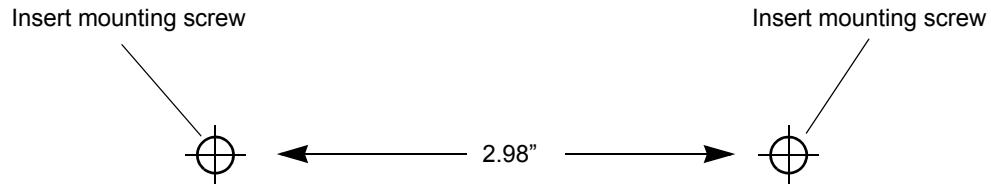

Figure 1-6 *Wall Mounting Template*

Chapter 2 Scanning

Introduction

This chapter provides beeper and LED definitions, techniques involved in scanning bar codes, general instructions and tips about scanning, and decode zone diagrams.

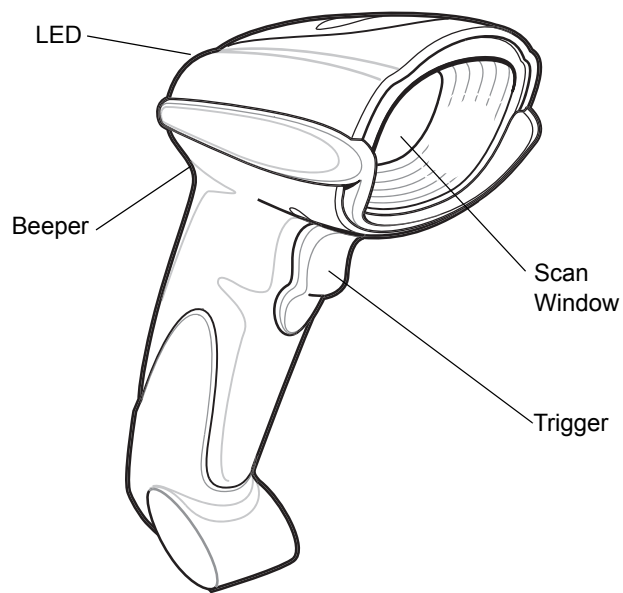

Figure 2-1 *Parts*

Beeper Definitions

The digital imager scanner issues different beep sequences and patterns to indicate status. [Table 2-1](#) defines beep sequences that occur during both normal scanning and while programming the digital imager scanner.

Table 2-1 *Beeper Definitions*

Beeper Sequence	Indication
Standard Use	
Low/medium/high beeps	Power up.
Short high beep	A bar code symbol was decoded (if decode beeper is enabled).
4 long low beeps	A transmission error was detected in a scanned symbol. The data is ignored. This occurs if the digital imager scanner is not properly configured. Check option setting.
5 low beeps	Conversion or format error.
Low/high/low beeps	ADF transmit error. See Chapter 11, Advanced Data Formatting .
High/high/high/low beeps	RS-232 receive error.
Parameter Menu Scanning	
Short high beep	Correct entry scanned or correct menu sequence performed.
Low/high beeps	Input error; incorrect bar code, programming sequence, or Cancel scanned; remain in ADF program mode.
High/low beeps	Keyboard parameter selected. Enter value using numeric bar codes.
High/low/high/low beeps	Successful program exit with change in parameter setting.
Low/high/low/high beeps	Out of host parameter storage space. Scan Set Default Parameter on page 4-4 .
Code 39 Buffering	
High/low beeps	New Code 39 data was entered into the buffer.
3 long high beeps	Code 39 buffer is full.
Low/high/low beeps	The Code 39 buffer was erased or there was an attempt to clear or transmit an empty buffer.
Low/high beeps	A successful transmission of buffered data.
Macro PDF	
2 long low beeps	File ID error. A bar code not in the current MPDF sequence was scanned.
3 long low beeps	Out of memory. There is not enough buffer space to store the current MPDF symbol.
4 long low beeps	Bad symbology. Scanned a 1D or 2D bar code in a MPDF sequence, a duplicate MPDF label, a label in an incorrect order, or trying to transmit an empty or illegal MPDF field.
5 long low beeps	Flushing MPDF buffer.

Table 2-1 *Beeper Definitions (Continued)*

Beeper Sequence	Indication
Fast warble beep	Aborting MPDF sequence.
Low/high beeps	Flushing an already empty MPDF buffer.
ADF Programming: Normal Data Entry. Duration of tones are short.	
High/low beeps	Enter another digit. Add leading zeros to the front if necessary.
Low/low beeps	Enter another alphabetic character or scan the End of Message bar code.
High/high beeps	Enter another criterion or action, or scan the Save Rule bar code.
High/low/high/low beeps	Rule saved. Rule entry mode exited.
High/low/low beeps	All criteria or actions cleared for current rule, continue entering rule.
Low beep	Delete last saved rule. The current rule is left intact.
Low/high/high beeps	All rules are deleted.
ADF Programming: Error Indications. Duration of tones are very long.	
Low/high/low/high beeps	Out of rule memory. Erase some existing rules, then try to save rule again. (It is not necessary to re-enter the current rule.)
Low/high/low beeps	Cancel rule entry. Rule entry mode exited because of an error or the user asked to exit rule entry.
Low/high beeps	Entry error, wrong bar code scanned. Re-enter criterion or action. All previously entered criteria and actions are retained. Criteria or action list is too long for a rule.
Host Specific	
USB only	
4 short high beeps	The digital imager scanner has not completed initialization. Wait several seconds and scan again.
Low/medium/high beeps upon scanning a USB device type	Communication with the bus must be established before the digital imager scanner can operate at the highest power level.
Low/medium/high beeps occur more than once.	The USB bus can put the digital imager scanner in a state where power to the digital imager scanner is cycled on and off more than once. This is normal and usually happens when the PC cold boots.
RS-232 only	
1 short high beep	A <BEL> character is received and Beep on <BEL> is enabled.

LED Definitions

In addition to beep sequences, the digital imager scanner uses a two-color LED to indicate status. [Table 2-2](#) defines LED colors that display during scanning.

Table 2-2 Standard LED Definitions

LED	Indication
Off	No power is applied to the digital imager scanner, or the digital imager scanner is on and ready to scan.
Green	A bar code was successfully decoded.
Red	A data transmission error or digital imager scanner malfunction occurred.

Scanning in Hand-Held Mode

Install and program the digital imager scanner (see [Setting Up the Digital Imager Scanner on page 1-3](#)). For assistance, contact the local supplier or Motorola Enterprise Mobility Support.

Scanning with the Digital Imager Scanner

1. Ensure all connections are secure (see the appropriate host chapter.)
2. Aim the digital imager scanner at the bar code.

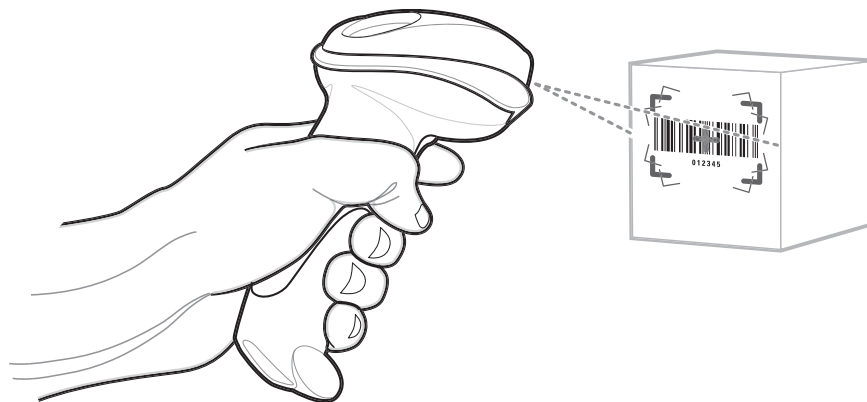

Figure 2-2 Scanning in Hand-Held Mode

- When the digital imager scanner senses movement, in its default **Auto Aim** trigger mode, it projects a red laser aiming pattern (*Figure 2-3*) which allows positioning the bar code or object within the field of view. (To turn off the default **Auto Aim** trigger mode, see *Trigger Mode on page 4-8*.) If necessary, the digital imager scanner turns on its red LEDs to illuminate the target bar code.

The DS6707-DP version uses a donut-shaped pattern with a center aiming dot.

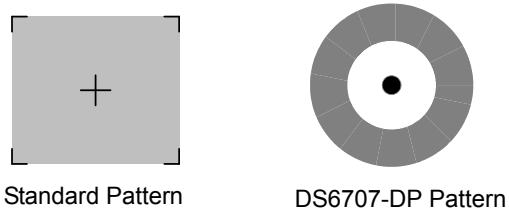

Figure 2-3 Laser Aiming Pattern

- Center the symbol in any orientation within the aiming pattern. Be sure the entire symbol is within the rectangular area formed by the brackets in the pattern.

When scanning with the DS6707-DP, ensure part of the bar code is visible on the inside of the donut-shaped pattern.

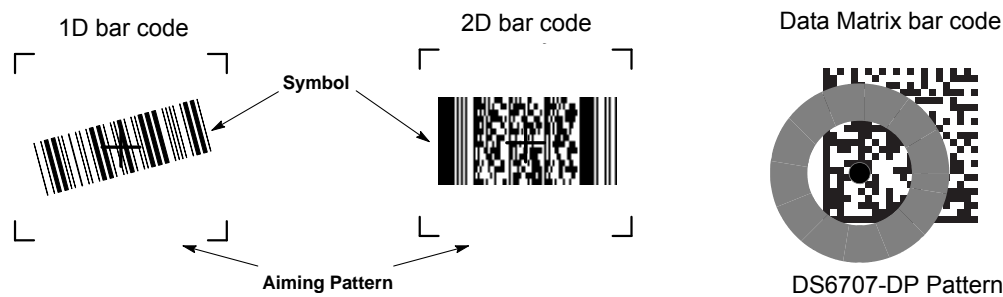

Figure 2-4 Placing Symbol in Aiming Pattern

- Hold the trigger until the digital imager scanner beeps, indicating the bar code is successfully decoded. For more information on beeper and LED definitions, see *Table 2-1* and *Table 2-2*.

This process usually occurs instantaneously. Steps 2 - 4 are repeated on poor quality or difficult bar codes, until the bar code is decoded, the trigger is released, or the Decode Session Timeout is reached.

Aiming

Hold the digital imager scanner between two and nine inches (depending on symbol density; see [Decode Zones on page 2-8](#)) from the symbol, centering the aiming pattern on the symbol. Ensure the cross hair falls on the symbol. For the DS6707-DP, ensure part of the symbol is visible within the donut-shaped pattern.

The aiming pattern is smaller when the digital imager scanner is closer to the symbol and larger when it is farther from the symbol. Scan symbols with smaller bars or elements (mil size) closer to the digital imager scanner, and those with larger bars or elements (mil size) farther from the digital imager scanner.

The digital imager scanner can also read a bar code presented within the aiming pattern but not centered. The top examples in [Figure 2-5](#) and [Figure 2-6](#) show acceptable aiming options, while the bottom examples can not decode.

✓ **NOTE** For best performance, ensure the pattern's cross hair, or in the case of the DS6707-DP the aiming dot, falls on the symbol.

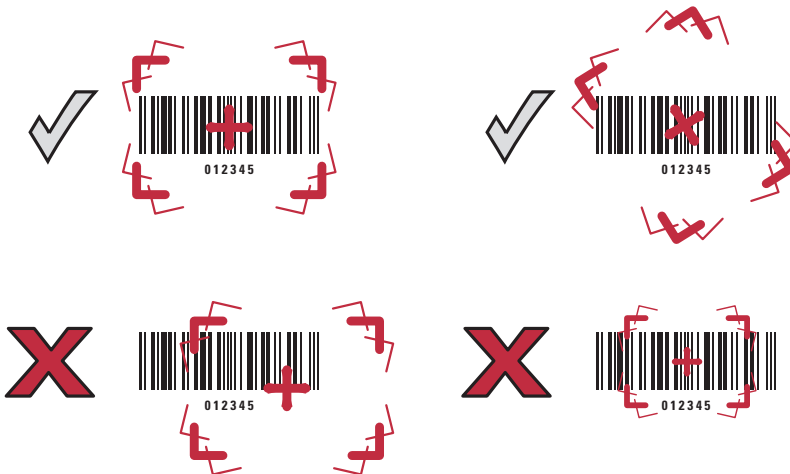

Figure 2-5 Acceptable and Incorrect Aiming - Standard Pattern



Figure 2-6 Acceptable and Incorrect Aiming - DS6707-DP Pattern

Scanning in Presentation Mode

The optional Intellistand adds greater flexibility to scanning operation. When you insert the digital imager scanner into the stand's "cup," the scanner's built-in sensor places the scanner in presentation (hands-free) mode. When you remove the digital imager scanner from the stand it operates in its normal hand-held mode.

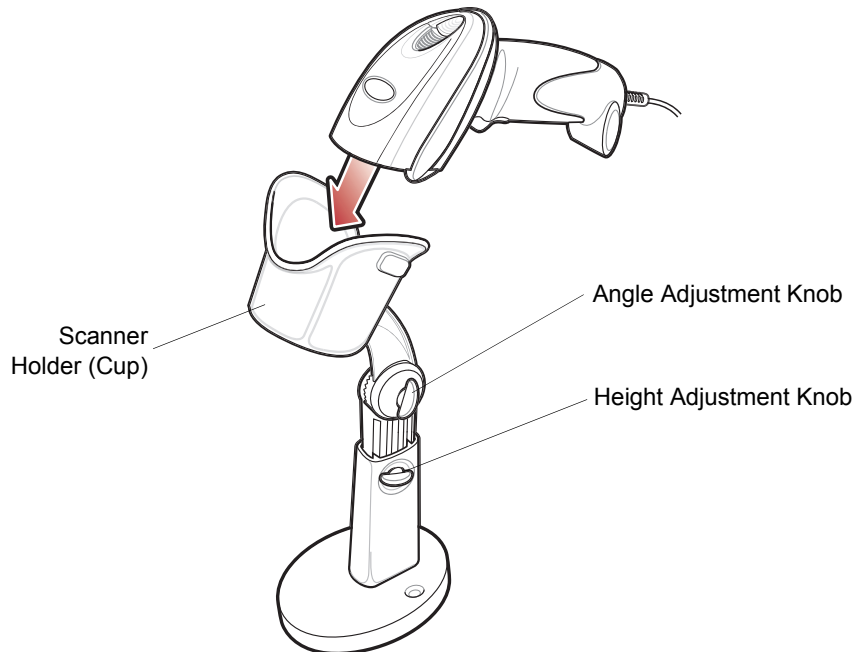

Figure 2-7 Inserting the Digital Imager Scanner in the Intellistand

To operate the digital imager scanner in the IntelliStand:

1. Connect the digital imager scanner to the host (see the appropriate host chapter for information on host connections).
2. Insert the digital imager scanner in the Intellistand by placing the front of the digital imager scanner into the stand's "cup" (see [Figure 2-7](#)).
3. Use the Intellistand's adjustment knobs to adjust the height and angle of the digital imager scanner.
4. Center the symbol in the aiming pattern. The entire symbol must be within the brackets.
5. Upon successful decode, the digital imager scanner beeps and the LED turns green. For more information on beeper and LED definitions, see [Table 2-1](#) and [Table 2-2](#).

Decode Zones

Symbol DS6707-SR Standard Range Digital Imager Scanner - 1D Bar Codes

Note: Typical performance at 73.4° F (23° C)
on high quality symbols.

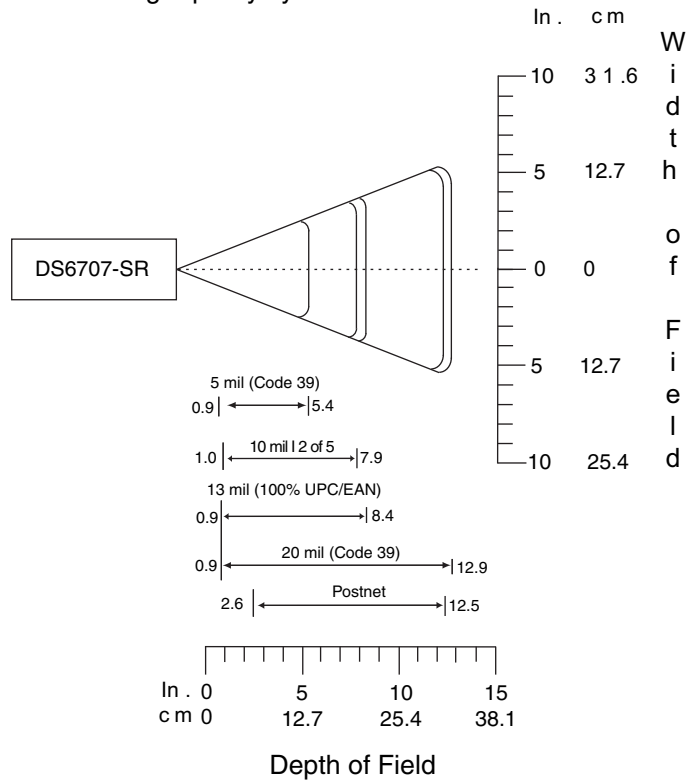

Figure 2-8 Symbol DS6707-SR Standard Range Decode Zone for 1D Bar Codes

Symbol DS6707-SR Standard Range Digital Imager Scanner - 2D Bar Codes

Note: Typical performance at 73.4° F (23° C)
on high quality symbols.

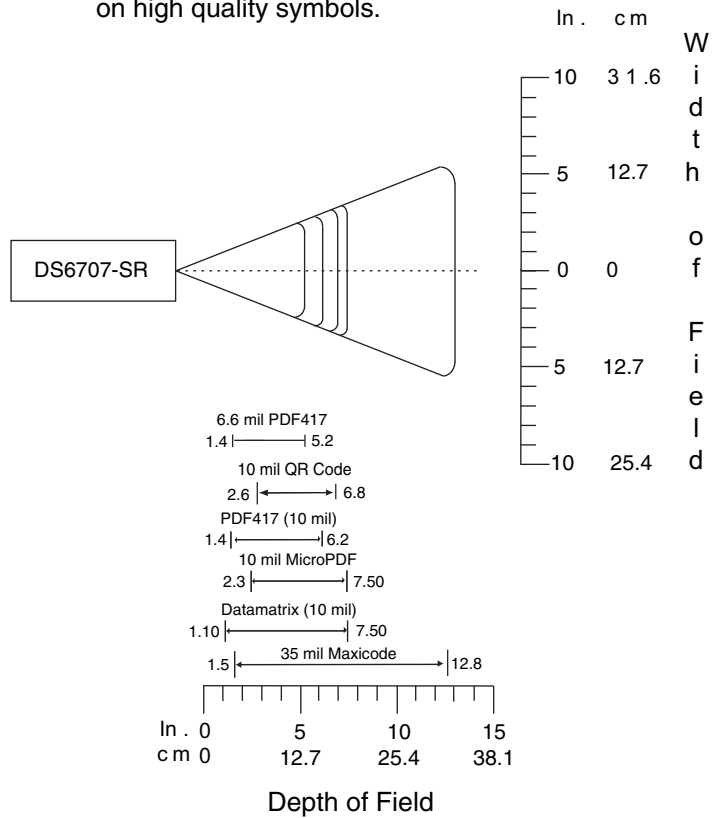

Figure 2-9 Symbol DS6707-SR Standard Range Decode Zone for 2D Bar Codes

Symbol DS6707-DC Document Capture Digital Imager Scanner - 1D Bar Codes

Note: Typical performance at 73.4° F (23° C) on high quality symbols.

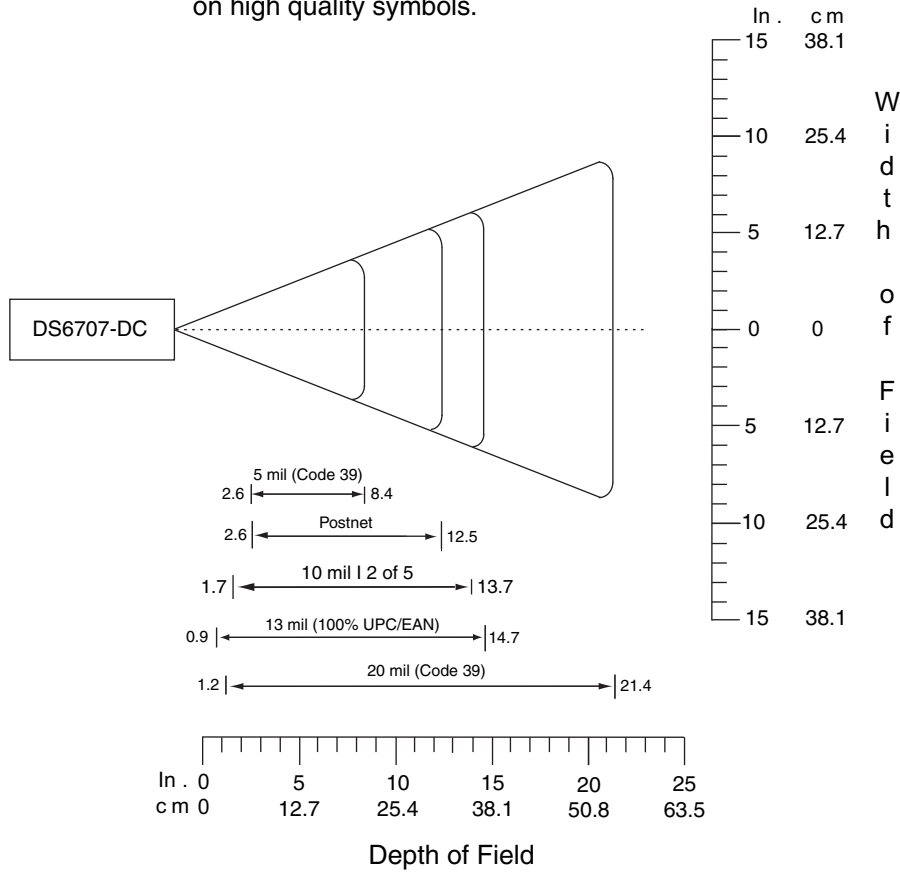

Figure 2-10 Symbol DS6707-DC Document Capture Digital Imager Scanner Decode Zone for 1D Bar Codes

Symbol DS6707-DC Document Capture Digital Imager Scanner - 2D Bar Codes

Note: Typical performance at 73.4° F (23° C)
on high quality symbols.

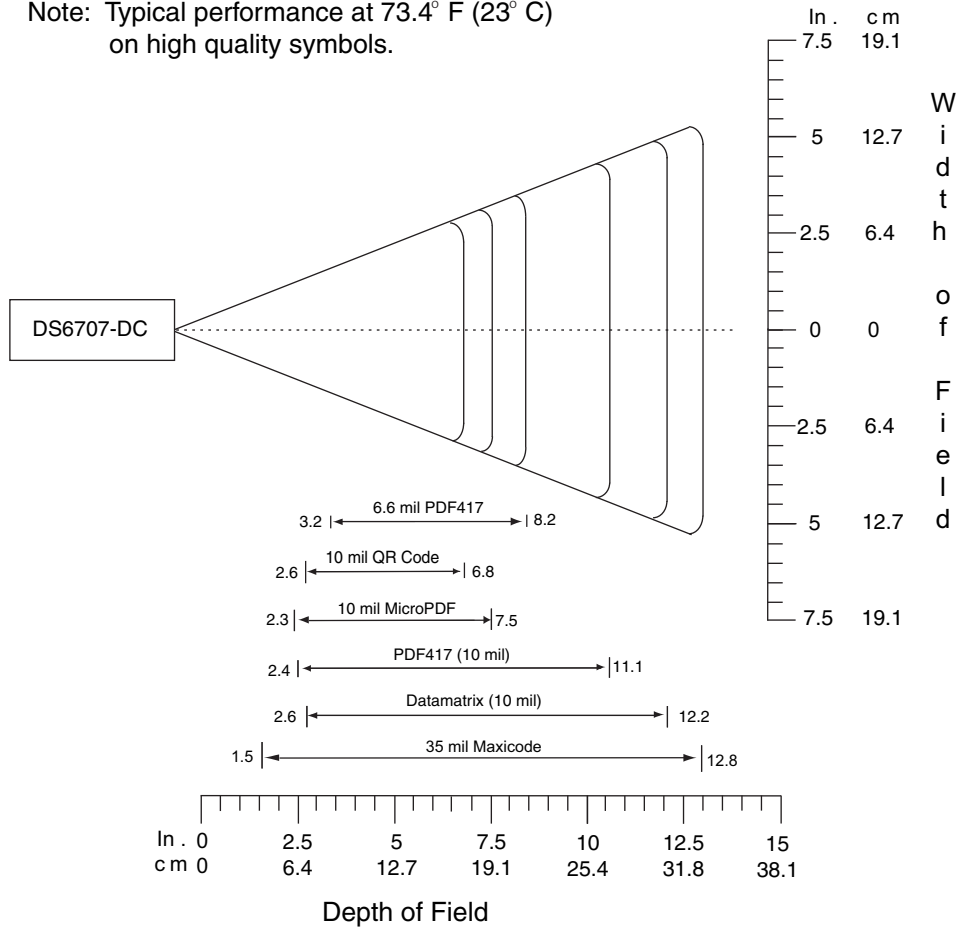

Figure 2-11 Symbol DS6707-DC Document Capture Digital Imager Scanner Decode Zone for 2D Bar Codes

Symbol DS6707-DP Direct Part Mark Digital Imager Scanner - 1D and PDF417 Bar Codes

Note: Typical performance at 73.4° F (23° C)
on high quality symbols.

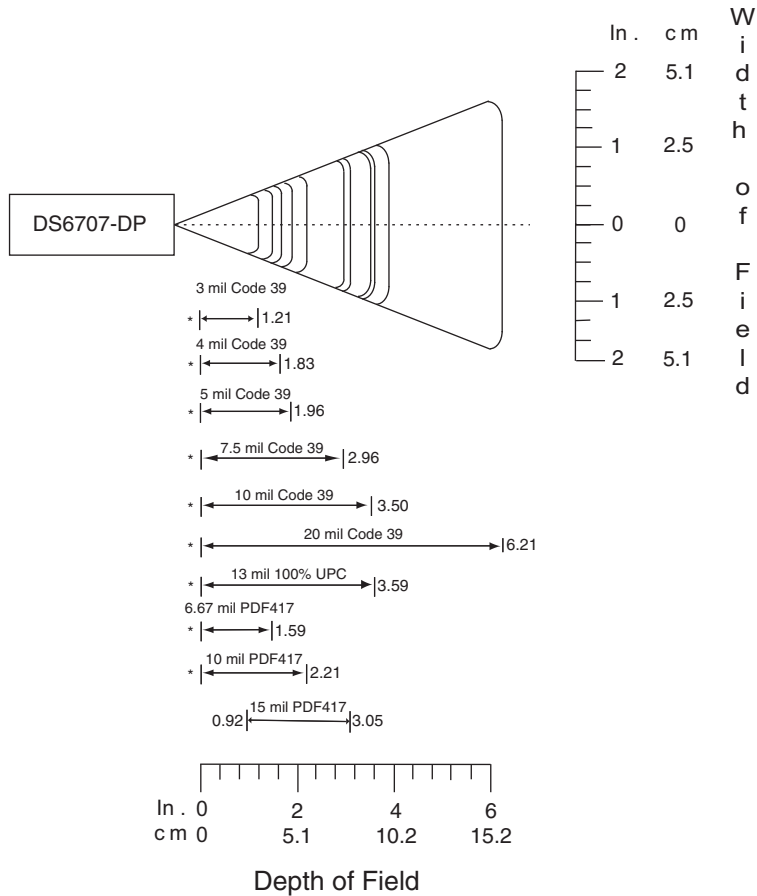

Figure 2-12 Symbol DS6707-DP Direct Part Mark Digital Imager Scanner Decode Zone for 1D and PDF417 Bar Codes

Symbol DS6707-DP Direct Part Mark Digital Imager Scanner - 2D Bar Codes

Note: Typical performance at 73.4 F°(23 C)°
on high quality symbols.

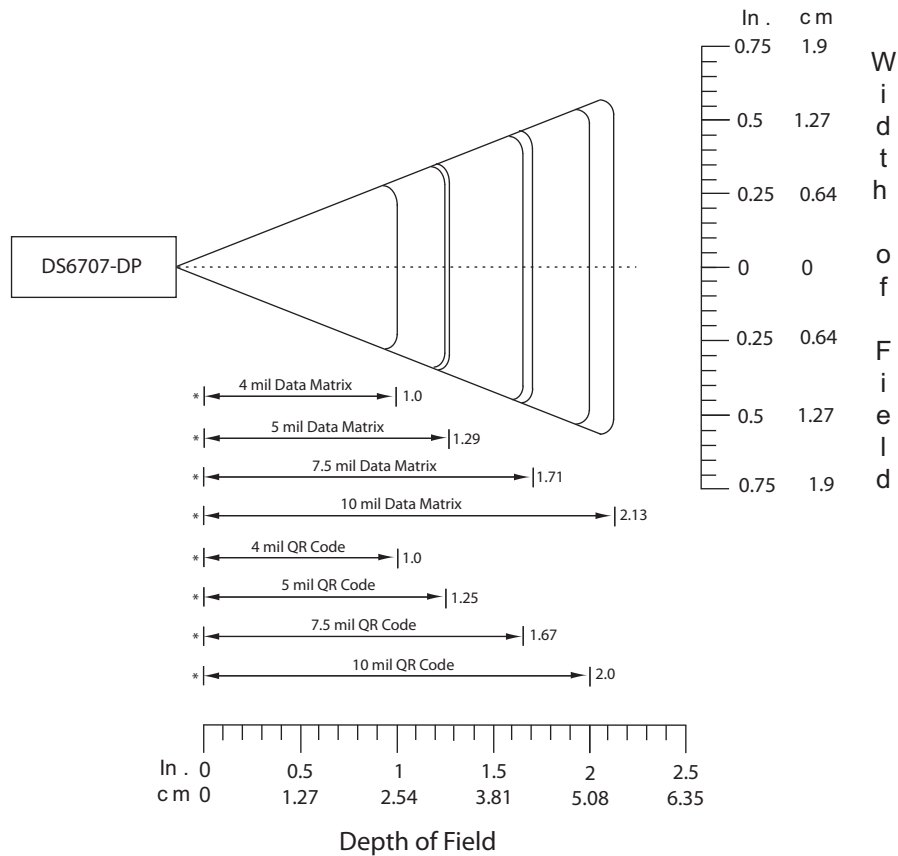

Figure 2-13 Symbol DS6707-DP Direct Part Mark Digital Imager Scanner Decode Zone for 2D Bar Codes

Symbol DS6707-HD High Density Digital Imager Scanner - 1D and PDF417 Bar Codes

Note: Typical performance at 73.4 F (23 C)°
on high quality symbols.

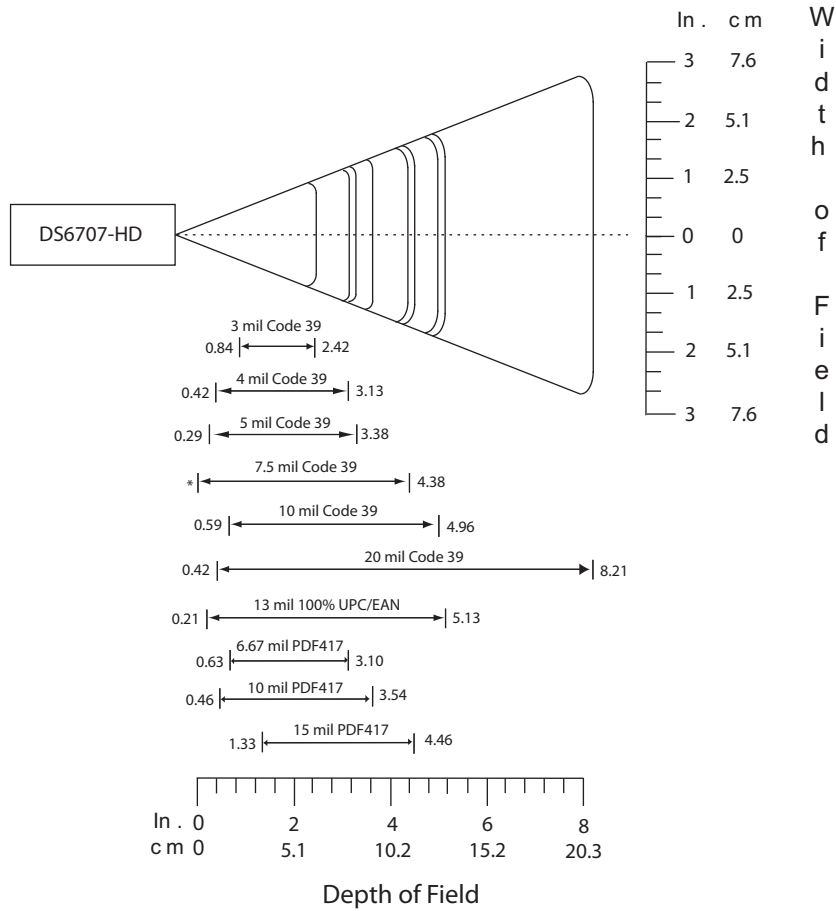

Figure 2-14 Symbol DS6707-HD High Density Digital Imager Scanner Decode Zone for 1D and PDF417 Bar Codes

Symbol DS6707-HD High Density Digital Imager Scanner - 2D Bar Codes

Note: Typical performance at 73.4° F (23° C)
on high quality symbols.

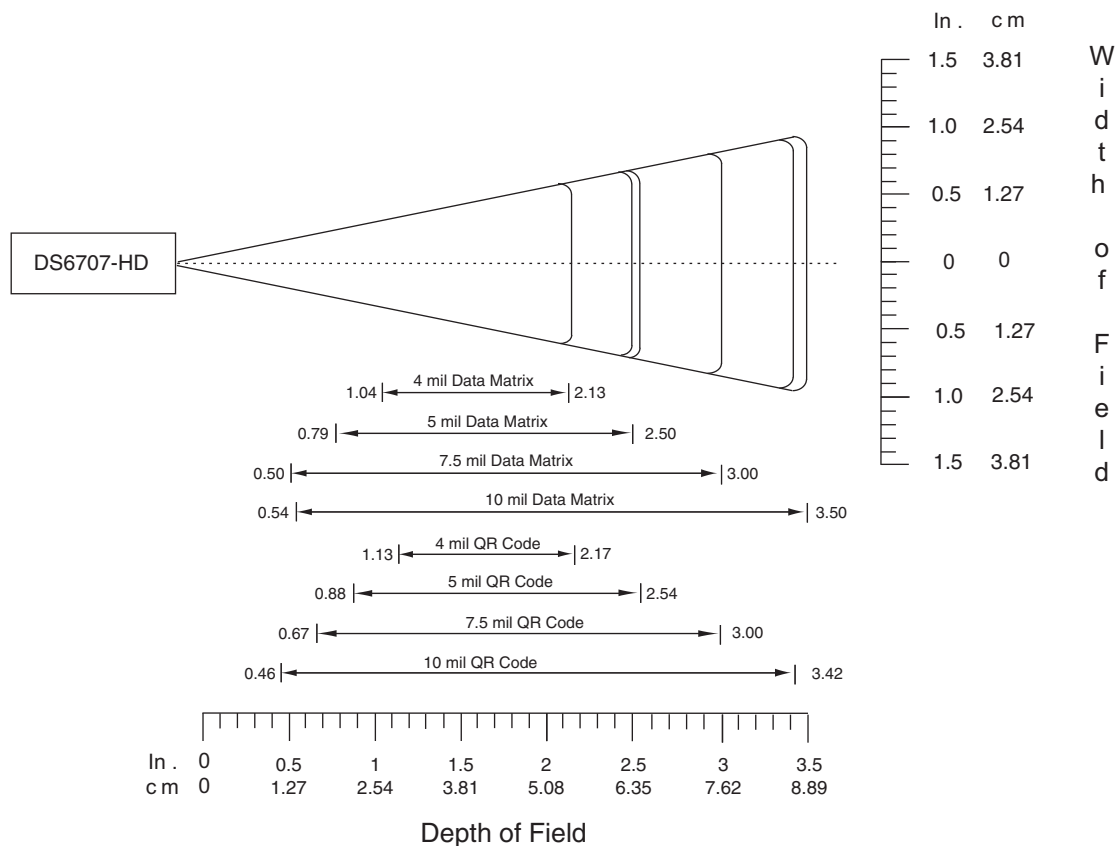

Figure 2-15 Symbol DS6707-HD High Density Digital Imager Scanner Decode Zone for 2D Bar Codes

Chapter 3 Maintenance & Technical Specifications

Introduction

This chapter provides suggested scanner maintenance, troubleshooting, technical specifications, and signal descriptions (pinouts).

Maintenance

Cleaning the scan window is the only maintenance required. A dirty window can affect scanning accuracy.

- Do not allow abrasive material to touch the window.
- Remove any dirt particles with a damp cloth.
- Wipe the window using a tissue moistened with ammonia/water.
- Do not spray water or other cleaning liquids directly into the window.

Troubleshooting

Table 3-1 *Troubleshooting*

Problem	Possible Causes	Possible Solutions
The aiming pattern does not appear when pressing the trigger.	No power to the digital imager scanner.	If the configuration requires a power supply, re-connect the power supply.
	Incorrect host interface cable is used.	Connect the correct host interface cable.
	Interface/power cables are loose.	Re-connect cables.
	Digital imager scanner is disabled.	See the technical person in charge of scanning.
	If using RS-232 Nixdorf B mode, CTS is not asserted.	Assert CTS line.
	Aiming pattern is disabled.	Enable the aiming pattern. See Decode Aiming Pattern on page 4-13 .
Scanner emits short low/short medium/short high beep sequence (power-up beep sequence) more than once.	The USB bus may put the digital imager scanner in a state where power to the digital imager scanner is cycled on and off more than once.	Normal during host reset.
Digital imager scanner emits aiming pattern, but does not decode the bar code.	Digital imager scanner is not programmed for the correct bar code type.	Program the digital imager scanner to read that type of bar code. See Chapter 10, Symbologies .
	Bar code symbol is unreadable.	Scan test symbols of the same bar code type to determine if the bar code is defaced.
	The symbol is not completely inside aiming pattern.	Move the symbol completely within the aiming pattern.
Digital imager scanner emits 4 short high beeps during decode attempt.	Digital imager scanner has not completed USB initialization.	Wait several seconds and scan again.

Table 3-1 Troubleshooting (Continued)

Problem	Possible Causes	Possible Solutions
Digital imager scanner decodes bar code, but does not transmit the data to the host.	Digital imager scanner is not programmed for the correct host type.	Scan the appropriate host type programming bar code. See the chapter corresponding to the host type.
	Interface cable is loose.	Re-connect the cable.
	If 4 long low beeps are heard, a transmission error occurred.	Set the digital imager scanner's communication parameters to match the host's setting.
	If 5 low beeps are heard, a conversion or format error occurred.	Configure the digital imager scanner's conversion parameters properly.
	If low/high/low beeps sound, an invalid ADF rule is detected.	Program the correct ADF rules.
	If high/low beeps sound, the digital imager scanner is buffering Code 39 data.	Normal scanning a Code 39 bar code and the Code 39 Buffering option is enabled.
Host displays scanned data incorrectly.	Digital imager scanner is not programmed to work with the host.	Scan the appropriate host type programming bar code.
		For RS-232, set the digital imager scanner's communication parameters to match the host's settings.
		Program the proper editing options (e.g., UPC-E to UPC-A Conversion).
Digital imager scanner emits high/high/high/low beeps when not in use.	RS-232 receive error.	Normal during host reset. Otherwise, set the digital imager scanner's RS-232 parity to match the host setting.
Digital imager scanner emits low/high beeps during programming.	Input error or Cancel bar code was scanned.	Scan the correct numeric bar codes within range for the parameter programmed.
Digital imager scanner emits low/high/low/high beeps during programming.	Out of ADF parameter storage space.	Erase all rules and re-program with shorter rules.
Digital imager scanner emits low/high/low beeps.	Clearing Code 39 buffer.	Normal when scanning the Code 39 Buffering Clear Buffer bar code or upon attempt to transmit an empty Code 39 buffer.
Digital imager scanner emits a power-up beep after changing USB host type.	The USB bus re-established power to the digital imager scanner.	Normal when changing USB host type.
Digital imager scanner emits one high beep when not in use.	In RS-232 mode, a <BEL> character was received and Beep on <BEL> option is enabled.	Normal when Beep on <BEL> is enabled and the digital imager scanner is in RS-232 mode.

✓ **NOTE** If after performing these checks the digital imager scanner still experiences problems, contact the distributor or contact Motorola Enterprise Mobility Support. See [page xvii](#) for the telephone numbers.

Technical Specifications

Table 3-2 *Technical Specifications*

Item	Description
Physical Characteristics	
Dimensions	Symbol DS6707-DP: 6.55 in. x 5.08 in. x 2.82 in. (16.6 cm x 12.9 cm x 7.1 cm) (H x L x W) All other models: 6.55 in. x 4.72 in. x 2.82 in. (16.6 cm x 11.9 cm x 7.1 cm) (H x L x W)
Weight:	Symbol DS6707-DP: 7.4 oz. (209 gm) All other models: 6.4 oz. (182 gm)
Voltage & Current:	5 +/-10%VDC @ 350 mA
Color	Cash Register White or Twilight Black (DS6707-DP is only available in Cash Register White)
Performance Characteristics	
Light Source	Aiming: 650 nm laser diode Illumination: 630 nm LED
Field of View (Vertical x Horizontal)	Document Capture: 35° (V) x 44° (H) Standard Range, Direct Part Mark, High Density: 34° (V) x 43° (H)
Roll	360°
Pitch	+/- 65°
Yaw	+/- 60°
Symbology Decode Capability	
1D	UPC/EAN and with supplementals, Bookland EAN, ISSN EAN, Code 128, Code 128 Full ASCII, GS1-128, ISBT 128, Code 39, Code 39 Full ASCII, Trioptic Code 39, Code 32, Code 93, Code 11, Interleaved 2 of 5, Discrete 2 of 5, Codabar (NW1), MSI, Chinese 2 of 5, Matrix 2 of 5, GS1 DataBar variants, IATA, Inverse 1D
Postal	US Postnet and Planet, UK Postal, Japan, Australian, Netherlands KIX Code, USPS 4CB/One Code/Intelligent Mail, UPU FICS Postal
PDF417 (& Variants)	PDF417, MicroPDF417, Composite Codes
2D	Data Matrix (ECC 200), MaxiCode, QR Code, Aztec
DPM (DS6707-DP only)	Data Matrix marks applied by dot peening; laser etch, ink marks, chemical etch, inkjet mold, cast and thermal spray

Table 3-2 *Technical Specifications (Continued)*

Item	Description	
Typical Working Distance: SR - Standard Range Focus	5 mil Code 39: 10 mil I 2 of 5: 13 mil 100% UPC/EAN: 20 mil Code 39: Postnet: 6.6 mil PDF417: 10 mil PDF417: 10 mil QR Code: 10 mil MicroPDF 10 mil Data Matrix: 35 mil Maxicode:	0.9 - 5.4 in. (2.3 - 13.7 cm) 1.0 - 7.9 in. (2.5 - 20.1 cm) 0.9 - 8.4 in. (2.3 - 21.3 cm) 0.9 - 12.9 in. (2.3 - 32.8 cm) 2.6 - 12.5 in. (6.6 - 31.8 cm) 3.4 - 5.7 in. (8.6 - 14.5 cm) 1.4 - 6.2 in. (3.6 - 15.7 cm) 2.6 - 6.8 in. (6.6 - 17.3 cm) 2.3 - 7.5 in. (5.8 - 19.1 cm) 1.1 - 7.5 in. (2.8 - 19.1 cm) 1.5 - 12.8 in. (3.8 - 32.5 cm)
Typical Working Distance: DC - Document Capture focus	5 mil Code 39: 10 mil I 2 of 5: 13 mil 100% UPC/EAN: 20 mil Code 39: Postnet: 6.6 mil PDF417: 10 mil PDF417: 10 mil QR Code: 10 mil MicroPDF: 10 mil Data Matrix: 35 mil Maxicode:	2.6 - 8.4 in. (6.6 - 21.3 cm) 1.7 - 13.7 in. (4.3 - 34.8 cm) 0.9 - 14.7 in. (2.3 - 37.3 cm) 1.2 - 21.4 in. (3.0 - 54.4 cm) 2.6 - 12.5 in. (6.6 - 31.8 cm) 3.2 - 8.2 in. (8.1 - 20.8 cm) 2.4 - 11.1 in. (6.1 - 28.2 cm) 2.6 - 6.8 in. (6.6 - 17.3 cm) 2.3 - 7.5 in. (5.8 - 19.1 cm) 2.6 - 12.2 in. (6.6 - 31.0 cm) 1.5 - 12.8 in. (3.8 - 32.5 cm)
Typical Working Distance: DP - Direct Part Mark focus	3 mil Code 39: 4 mil Code 39: 5 mil Code 39: 7.5 mil Code 39: 10 mil Code 39: 20 mil Code 39: 13 mil 100% UPC/EAN: 6.67 mil PDF417: 10 mil PDF417: 15 mil PDF417: 4 mil Data Matrix: 5 mil Data Matrix: 7.5 mil Data Matrix: 10 mil Data Matrix: 4 mil QR Code: 5 mil QR Code: 7.5 mil QR Code: 10 mil QR Code:	Up to 1.21 in. (3.07 cm) Up to 1.83 in. (4.65 cm) Up to 1.96 in. (4.98 cm) Up to 2.96 in. (7.52 cm) Up to 3.50 in. (8.89 cm) Up to 6.21 in. (15.77 cm) Up to 3.59 in. (9.12 cm) Up to 1.59 in. (4.04 cm) Up to 2.21 in. (5.61 cm) 0.92 - 3.05 in. (2.34 - 7.75 cm) Up to 1.00 in. (2.54 cm) Up to 1.29 in. (3.28 cm) Up to 1.71 in. (4.34 cm) Up to 2.13 in. (5.41 cm) Up to 1.00 in. (2.54 cm) Up to 1.25 in. (3.18 cm) Up to 1.67 in. (4.24 cm) Up to 2.00 in. (5.08 cm)

Table 3-2 *Technical Specifications (Continued)*

Item	Description										
Typical Working Distance: HD - High Density	3 mil Code 39: 0.84 - 2.42 in. (2.13 - 6.15 cm) 4 mil Code 39: 0.42 - 3.13 in. (1.07 - 7.95 cm) 5 mil Code 39: 0.29 - 3.38 in. (0.74 - 8.59 cm) 7.5 mil Code 39: Up to 4.38 in. (11.13 cm) 10 mil Code 39: 0.59 - 4.96 in. (1.50 - 12.60 cm) 20 mil Code 39: 0.42 - 8.21 in. (1.07 - 20.85 cm) 13 mil 100% UPC: 0.21 - 5.13 in. (0.53 - 13.03 cm) 6.67 mil PDF417: 0.63 - 3.10 in. (1.60 - 7.87 cm) 10 mil PDF417: 0.46 - 3.54 in. (1.17 - 9.00 cm) 15 mil PDF417: 1.33 - 4.46 in. (3.38 - 11.33 cm) 4 mil Data Matrix: 1.04 - 2.13 in. (2.64 - 5.41 cm) 5 mil Data Matrix: 0.79 - 2.50 in. (2.01 - 6.35 cm) 7.5 mil Data Matrix: 0.50 - 3.00 in. (1.27 - 7.62 cm) 10 mil Data Matrix: 0.54 - 3.50 in. (1.37 - 8.89 cm) 4 mil QR Code: 1.13 - 2.17 in. (2.87 - 5.51 cm) 5 mil QR Code: 0.88 - 2.54 in. (2.24 - 6.45 cm) 7.5 mil QR Code: 0.67 - 3.00 in. (1.70 - 7.62 cm) 10 mil QR Code: 0.46 - 3.42 in. (1.17 - 8.69 cm)										
Print Contrast	25% minimum reflectance										
Motion Tolerances	Horizontal Velocity: 5 in. (12.7 cm) per second										
Interfaces Supported	RS-232C (Standard, Nixdorf, ICL, & Fujitsu) and USB (Standard, IBM SurePOS, Macintosh) allows for connectivity to all of the above plus many non-standard interfaces.										
Imaging Characteristics											
Image (# of Pixels)	1.3 Mega Pixel: 1280 (H) x 1024 (V)										
Graphics Format Support	Images can be exported as Bitmap, JPEG, and TIFF										
Image Transfer Speed	USB 1.1: Up to 12 Megabits/second RS232: Up to 115 kB Baud Rate										
Image Transfer Time	Typical USB application is ~ 0.2 seconds with a compressed JPEG of 100 kB										
Imaging Distance (Vertical x Horizontal)	<table border="0"> <thead> <tr> <th>Documents Sizes:</th> <th>Minimum Distance (Approximate)</th> </tr> </thead> <tbody> <tr> <td>2.125 x 3.375 in. (5.4 x 8.6 cm)</td> <td>2.4 in. (6.1 cm)</td> </tr> <tr> <td>4 x 6 in. (10.2 x 15.2 cm)</td> <td>5.7 in. (14.5 cm)</td> </tr> <tr> <td>5 x 7 in. (12.7 x 17.8 cm)</td> <td>11.9 in. (30.2 cm)</td> </tr> <tr> <td>8½ x 11 (21.6 x 28 cm)</td> <td>11.9 in.</td> </tr> </tbody> </table> Ranges are from the nose of the scanner and are based on document capture focus only.	Documents Sizes:	Minimum Distance (Approximate)	2.125 x 3.375 in. (5.4 x 8.6 cm)	2.4 in. (6.1 cm)	4 x 6 in. (10.2 x 15.2 cm)	5.7 in. (14.5 cm)	5 x 7 in. (12.7 x 17.8 cm)	11.9 in. (30.2 cm)	8½ x 11 (21.6 x 28 cm)	11.9 in.
Documents Sizes:	Minimum Distance (Approximate)										
2.125 x 3.375 in. (5.4 x 8.6 cm)	2.4 in. (6.1 cm)										
4 x 6 in. (10.2 x 15.2 cm)	5.7 in. (14.5 cm)										
5 x 7 in. (12.7 x 17.8 cm)	11.9 in. (30.2 cm)										
8½ x 11 (21.6 x 28 cm)	11.9 in.										

Table 3-2 *Technical Specifications (Continued)*

Item	Description
User Environment	
Operating Temperature	32° F to 104° F (0° C to 40° C)
Storage Temperature	-40° F to 158° F (-40° C to 70° C)
Humidity	5% to 95%, non-condensing
Drop Specifications	Withstands multiple 5 ft. (1.52 m) drops to concrete at operating temperature extremes, and multiple 6 ft. (1.8 m) drops to concrete at room temperature (23° C)
Ambient Light Immunity	Immune to normal artificial indoor and natural outdoor (direct sunlight) lighting.
Regulatory	
Electrical Safety	UL6950-1, CSA C22.2 No. 60950-1, EN60950-1 / IEC60950-1
Laser Safety	EN60825-1:1994 +A1: 2002 +A2 :2001, IEC60825-1, 21CFR1040.10 and 21CFR1040.11, CDRH Class II, IEC Class 2
EMI/RFI	FCC Part 15 Class B, ICES-003 Class B, CISPR 22, CISPR 24 Medical Electrical Equipment: EN60601-1-2: 2002
RoHS	Compliance with RoHS Directive 2002/95/EEC
Mounting Options (Accessories)	Intellistand with adjustable height: 5-10 in. (12.7-25.4 cm) and adjustable angle: 0° - 90° Desktop & Wall-mount holders are also available.
Power Supplies	Power supplies are available for applications that do not supply power over the host cable.

Digital Imager Scanner Signal Descriptions

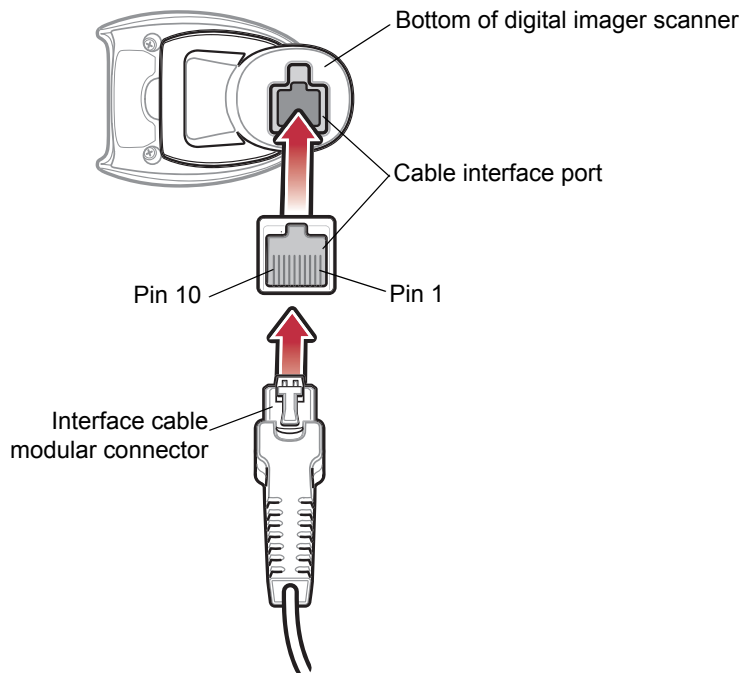

Figure 3-1 Digital Imager Scanner Cable Pinouts

The signal descriptions in [Table 3-3](#) apply to the connectors on the Symbol DS6707 digital imager scanner and are for reference only.

Table 3-3 Symbol DS6707 Digital Imager Scanner Signal Pin-outs

Pin	RS-232/SSI	USB
1	Reserved	Jump to Pin 6
2	Power	Power
3	Ground	Ground
4	TxD	Reserved
5	RxD	D +
6	RTS	Jump to Pin 1
7	CTS	D -
8	Reserved	Reserved
9	Reserved	Reserved
10	Reserved	Reserved

Chapter 4 User Preferences & Miscellaneous Digital Imager Scanner Options

Introduction

You can program the digital imager scanner to perform various functions, or activate different features. This chapter describes each user preference feature and provides programming bar codes for selecting these features.

The digital imager scanner ships with the settings shown in [Table 4-1 on page 4-2](#) (also see [Appendix A, Standard Default Parameters](#) for all host device and miscellaneous defaults). If the default values suit requirements, programming is not necessary.

To set feature values, scan a single bar code or a short bar code sequence. The settings are stored in non-volatile memory and are preserved even when you power down the digital imager scanner.

✓ **NOTE** Most computer monitors allow scanning the bar codes directly on the screen. When scanning from the screen, be sure to set the document magnification to a level where you can see the bar code clearly, and bars and/or spaces are not merging.

If not using a USB cable, select a host type after the power-up beeps sound. See [Chapter 6, SSI Interface Chapter 7, USB Interface](#) and [Chapter 8, RS-232 Interface](#) for specific host information. This is only necessary upon the first power-up when connected to a new host.

To return all features to default values, scan the [Set Default Parameter on page 4-4](#). Throughout the programming bar code menus, asterisks (*) indicate default values.



* Indicates Default — * **High Volume** — Feature/Option
(00h) — Option Hex Value for programming via SSI command

Scanning Sequence Examples

In most cases, scanning one bar code sets the parameter value. For example, to set the beeper tone to high, scan the **High Frequency** (beeper tone) bar code listed under [Beeper Tone on page 4-5](#). The digital imager scanner issues a fast warble beep and the LED turns green, signifying a successful parameter entry.

Other parameters, such as **Serial Response Time-Out** or **Data Transmission Formats**, require scanning several bar codes. See these parameter descriptions for this procedure.

Errors While Scanning

Unless otherwise specified, to correct an error during a scanning sequence, just re-scan the correct parameter.

User Preferences and Miscellaneous Options - Parameter Defaults

[Table 4-1](#) lists defaults for user preferences parameters. There are two ways to change the default values:

- Scan the appropriate bar codes in this guide. These new values replace the standard default values in memory. To recall the default parameter values, see the [Set Default Parameter on page 4-4](#).
- Download data through the device's serial port using SSI. Hexadecimal parameter numbers appear in this chapter below the parameter title, and options appear in parenthesis beneath the accompanying bar codes. See the *Simple Serial Interface (SSI) Programmer's Guide* for detailed instructions for changing parameters using this method.

✓ **NOTE** See [Appendix A, Standard Default Parameters](#) for all user preferences, hosts, symbologies, and miscellaneous default parameters.

Table 4-1 User Preferences Parameter Defaults

Parameter	Parameter Number	Default	Page Number
User Preferences			
Set Default Parameter		Restore Defaults	4-4
Parameter Scanning	ECh	Enable	4-5
Beeper Tone	91h	Medium	4-5
Beeper Volume	8Ch	High	4-6
Power Mode	80h	Continuous On	4-6
Time Delay to Low Power Mode	92h	1 Minute	4-7
Trigger Mode	8Ah	Auto Aim	4-8
Picklist Mode	F0h, 92h	Disabled Always	4-9
Decode Session Timeout	88h	9.9 Sec	4-10
Timeout Between Decodes, Same Symbol	89h	0.6 Sec	4-10

Table 4-1 *User Preferences Parameter Defaults (Continued)*

Parameter	Parameter Number	Default	Page Number
Beep After Good Decode	38h	Enable	4-11
Decoding Illumination	F0h, 2Ah	Enable	4-11
DP Illumination	F1h, 3Bh	Auto	4-12
Decode Aiming Pattern	F0h, 32h	Enable	4-13
Fuzzy 1D Processing	F1h, 02h	Enable	4-13
Decode Mirror Images	F1h, 19h	Never	4-14
Miscellaneous Options			
Transmit Code ID Character	2Dh	None	4-15
Prefix Value	63h, 69h	7013 <CR><LF>	4-16
Suffix 1 Value Suffix 2 Value	62h, 68h 64h, 6Ah	7013 <CR><LF>	4-16
Scan Data Transmission Format	EBh	Data as is	4-17
FN1 Substitution Values	67h, 6Dh	Set	4-18
Transmit "No Read" Message	5Eh	Disable	4-19

User Preferences

Set Default Parameter

You can reset the Symbol DS6707 to two types of defaults: factory defaults or custom defaults. Scan the appropriate bar code below to reset the scanner to its default settings and/or set its current settings as custom defaults.

- **Restore Defaults** - Scan this bar code to reset all default parameters as follows.
 - If you previously set custom defaults by scanning **Write to Custom Defaults**, scan **Restore Defaults** to retrieve and restore the scanner's custom default settings.
 - If you did not set custom defaults, scan **Restore Defaults** to restore the factory default values listed in [Table A-1](#).
- **Set Factory Defaults** - Scan this bar code to restore the factory default values listed in [Table A-1](#). This deletes any custom defaults set.
- **Write to Custom Defaults** - Scan this bar code to set the current scanner settings as custom defaults. Once set, you can recover custom default settings by scanning **Restore Defaults**.



***Restore Defaults**



Set Factory Defaults



Write to Custom Defaults

Parameter Scanning

Parameter # ECh

To disable decoding of parameter bar codes, including the **Set Defaults** parameter bar codes, scan the **Disable Parameter Scanning** bar code below. To re-enable decoding of parameter bar codes, scan **Enable Parameter Scanning**.



*Enable Parameter Scanning
(01h)



Disable Parameter Scanning
(00h)

Beeper Tone

Parameter # 91h

To select a decode beep frequency (tone), scan the **Low Frequency**, **Medium Frequency**, or **High Frequency** bar code.



Low Frequency
(02h)



*Medium Frequency
(Optimum Setting)
(01h)

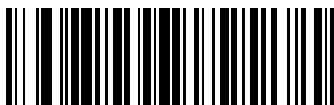

High Frequency
(00h)

Beeper Volume

Parameter # 8Ch

To select a beeper volume, scan the **Low Volume**, **Medium Volume**, or **High Volume** bar code.



Low Volume
(02h)



Medium Volume
(01h)



*High Volume
(00h)

Power Mode

Parameter # 80h

This parameter determines whether or not power remains on after a decode attempt. In reduced power mode, the digital imager scanner enters into a low power consumption mode to preserve battery life after each decode attempt. In continuous power mode, power remains on after each decode attempt.



*Continuous On
(00h)



Reduced Power Mode
(01h)

Time Delay to Low Power Mode

Parameter # 92h

✓ **NOTE** This parameter only applies when Power Mode is set to Reduced Power.

This parameter sets the time the digital imager scanner remains active after decoding. The digital imager scanner wakes upon trigger pull or when the host attempts to communicate with the digital imager scanner.



1 Second
(11h)



5 Seconds
(15h)



***1 Minute**
(21h)



5 Minutes
(25h)



15 Minutes
(2Bh)



1 Hour
(31h)

Trigger Mode

Parameter # 8Ah

Select one of the following trigger modes for the digital imager scanner:

- **Level** - A trigger pull activates decode processing. Decode processing continues until the bar code is decoded, the trigger is released, or the Decode Session Timeout is reached.
- **Blink** - This trigger mode is used in presentation (hands-free) mode. The digital imager scanner activates decode processing when it detects a bar code in its field of view. Decoding range is reduced in this mode.
- **Auto Aim** - This trigger mode turns on the red laser aiming pattern when the digital imager scanner senses motion. A trigger pull activates decode processing. After 2 seconds of inactivity the red laser aiming pattern automatically shuts off.
- **Host** - A host command issues the triggering signal. The digital scanner interprets an actual trigger pull as a Level triggering option.



Level
(00h)

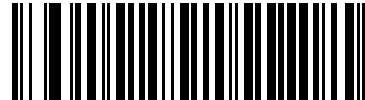

Blink
(07h)



*Auto Aim
(09h)



Host
(08h)

Picklist Mode

Parameter # F0h 92h

Picklist mode enables the digital imager scanner to decode only bar codes that are aligned under the laser crosshair. Select one of the following picklist modes for the digital imager scanner:

- **Disabled Always** - Picklist mode is always disabled.
- **Enabled Out of Scanstand** - Picklist mode is enabled when the digital imager scanner is out of presentation (scanstand) mode and disabled when the digital imager scanner is in presentation mode.
- **Enabled Always**- Picklist mode is always enabled.



***Disabled Always
(00h)**



**Enabled Out of Scanstand
(01h)**



**Enabled Always
(02h)**

Decode Session Timeout

Parameter # 88h

This parameter sets the maximum time decode processing continues during a scan attempt. It is programmable in 0.1 second increments from 0.5 to 9.9 seconds. The default timeout is 9.9 seconds.

To set a Decode Session Timeout, scan the bar code below. Next, scan two numeric bar codes from [Appendix D, Numeric Bar Codes](#) that correspond to the desired on time. Enter a leading zero for single digit numbers. For example, to set a Decode Session Timeout of 0.5 seconds, scan the bar code below, then scan the **0** and **5** bar codes. To correct an error or change the selection, scan **Cancel** on [page D-2](#).



Decode Session Timeout

Timeout Between Decodes, Same Symbol

Parameter # 89h

Use this option in presentation (hands-free) mode to prevent the beeper from continuously beeping when a symbol is left in the digital imager scanner's field of view. It is programmable in 0.1 second increments from 0.0 to 9.9 seconds. The default interval is 0.6 seconds.

To select the timeout between decodes for the same symbol, scan the bar code below, then scan two numeric bar codes from [Appendix D, Numeric Bar Codes](#) that correspond to the desired interval, in 0.1 second increments.



Timeout Between Decodes, Same Symbol

Beep After Good Decode

Parameter # 38h

Select a bar code below to choose whether or not the digital scanner beeps after a good decode (or image capture in Snapshot mode). If you select **Do Not Beep After Good Decode**, the beeper still operates during parameter menu scanning and to indicate error conditions.



*Beep After Good Decode
(Enable)
(01h)

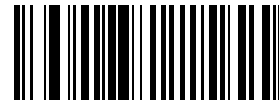

Do Not Beep After Good Decode
(Disable)
(00h)

Decoding Illumination

Parameter # F0h, 2Ah

Selecting **Enable Decoding Illumination** causes the digital imager scanner to flash illumination to aid decoding. Select **Disable Decoding Illumination** to prevent the digital imager scanner from using decoding illumination.

Enabling illumination usually results in superior images. The effectiveness of the illumination decreases as the distance to the target increases.



*Enable Decoding Illumination
(01h)



Disable Decoding Illumination
(00h)

DP Illumination

Parameter # F1h, 3Bh

This parameter controls whether the digital imager scanner uses direct or indirect illumination. Options are:

- **Auto Illumination:** Alternates direct and indirect illumination.
- **Direct Illumination:** Optimizes scanning of symbols printed on low contrast or opaque surfaces. For best results, hold the scanner at an angle when scanning using this option.
- **Indirect Illumination:** Optimizes scanning of symbols printed on mirror-like or shiny surfaces.



***Auto Illumination
(01h)**



**Direct Illumination
(02h)**



**Indirect Illumination
(03h)**

Decode Aiming Pattern

Parameter # F0h, 32h

This parameter only applies when in Decode Mode. Select **Enable Decode Aiming Pattern** to project the aiming pattern during bar code capture, or **Disable Decode Aiming Pattern** to turn the aiming pattern off.



NOTE With picklist enabled, the decode aiming pattern flashes even when the **Decode Aiming Pattern** is disabled.



*Enable Decode Aiming Pattern
(02h)

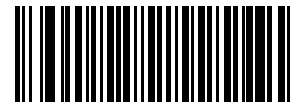

Disable Decode Aiming Pattern
(00h)

Fuzzy 1D Processing

Parameter # F1h 02h

This option is enabled by default to optimize decode performance on 1D bar codes, including damaged and poor quality symbols. Disable this only if you experience time delays when decoding 2D bar codes, or in detecting a no decode.



*Enable Fuzzy 1D Processing
(01h)



Disable Fuzzy 1D Processing
(00h)

Decode Mirror Images (Data Matrix Only)

Parameter # F1h 19h

Select an option for decoding mirror image Data Matrix bar codes:

- Always - decode only Data Matrix bar codes that are mirror images
- Never - do not decode Data Matrix bar codes that are mirror images
- Auto - decode both mirrored and unmirrored Data Matrix bar codes.



***Never**
(00h)



Always
(01h)



Auto
(02h)

Miscellaneous Scanner Parameters

Transmit Code ID Character

Parameter # 2Dh

A Code ID character identifies the code type of a scanned bar code. This is useful when the digital imager scanner is decoding more than one code type. In addition to any single character prefix already selected, the Code ID character is inserted between the prefix and the decoded symbol.

Select no Code ID character, a Symbol Code ID character, or an AIM Code ID character. For Code ID Characters, see [Symbol Code Identifiers on page B-1](#) and [AIM Code Identifiers on page B-3](#).

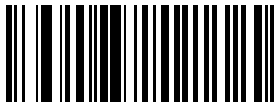

Symbol Code ID Character
(02h)



AIM Code ID Character
(01h)

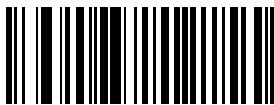

*None
(00h)

Prefix/Suffix Values

Key Category Parameter # P = 63h, S1 = 62h, S2 = 64h

Decimal Value Parameter # P = 69h, S1 = 68h, S2 = 6Ah

You can append a prefix and/or one or two suffixes to scan data for use in data editing. To set a value for a prefix or suffix, scan a four-digit number (i.e., four bar codes from [Appendix D, Numeric Bar Codes](#)) that corresponds to that value. See [Table E-1 on page E-1](#) for the four-digit codes.

When using host commands to set the prefix or suffix, set the key category parameter to 1, then set the 3-digit decimal value. See [Table E-1 on page E-1](#) for the four-digit codes.

To correct an error or change a selection, scan [Cancel on page D-2](#).

✓ **NOTE** To use Prefix/Suffix values, first set the [Scan Data Transmission Format on page 4-17](#).

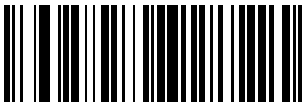

Scan Prefix
(07h)



Scan Suffix 1
(06h)



Scan Suffix 2
(08h)



Data Format Cancel

Scan Data Transmission Format

Parameter # EBh

To change the scan data format, scan one of the following bar codes corresponding to the desired format.

✓ **NOTE** If using this parameter, do not use ADF rules to set the prefix/suffix.

To set values for the prefix and/or suffix, see [Prefix/Suffix Values on page 4-16](#).



*Data As Is
(00h)



<DATA> <SUFFIX 1>
(01h)



<DATA> <SUFFIX 2>
(02h)



<DATA> <SUFFIX 1> <SUFFIX 2>
(03h)



<PREFIX> <DATA >
(04h)

Scan Data Transmission Format (continued)



FN1 Substitution Values

Key Category Parameter # 67h

Decimal Value Parameter # 6Dh

The Wedge and USB HID Keyboard hosts support a FN1 Substitution feature. Enabling this substitutes any FN1 character (0x1b) in a GS1-128 bar code with a user-defined value. This value defaults to 7013 (Enter Key).

When using host commands to set the FN1 substitution value, set the key category parameter to 1, then set the 3-digit keystroke value. See the ASCII Character Set table for the current host interface for the desired value.

To select a FN1 substitution value via bar code menus:

1. Scan the bar code below.



2. Locate the keystroke desired for FN1 Substitution in the ASCII Character Set table for the current host interface. Enter the 4-digit ASCII value by scanning each digit in [Appendix D, Numeric Bar Codes](#).

To correct an error or change the selection, scan **Cancel**.

To enable FN1 substitution for USB HID keyboard, scan the **Enable FN1 Substitution** bar code on [page 4-18](#).

Transmit "No Read" Message

Parameter # 5Eh

Scan a bar code below to select whether or not to transmit a No Read message. Enable this to transmit the characters NR when a bar code is not decoded. Disable this to send nothing to the host if a symbol does not decode.



**Enable No Read
(01h)**



***Disable No Read
(00h)**

Chapter 5 Imaging Preferences

Introduction

You can program the digital imager scanner to perform various functions, or activate different features. This chapter describes imaging preference features and provides programming bar codes for selecting these features.

The digital imager scanner ships with the settings in [Imaging Preferences Parameter Defaults on page 5-2](#) (also see [Appendix A, Standard Default Parameters](#) for all host device and miscellaneous defaults). If the default values suit requirements, programming is not necessary.

To set feature values, scan a single bar code or a short bar code sequence. The settings are stored in non-volatile memory and are preserved even when you power down the digital imager scanner.

✓ **NOTE** Most computer monitors allow scanning the bar codes directly on the screen. When scanning from the screen, be sure to set the document magnification to a level where you can see the bar code clearly, and bars and/or spaces are not merging.

If not using a USB cable, select a host type after the power-up beeps sound. See [Chapter 6, SSI Interface](#), [Chapter 7, USB Interface](#) and [Chapter 8, RS-232 Interface](#) for specific host information. This is only necessary upon the first power-up when connecting to a new host.

To return all features to default values, scan the [Set Default Parameter on page 4-4](#). Throughout the programming bar code menus, asterisks (*) indicate default values.

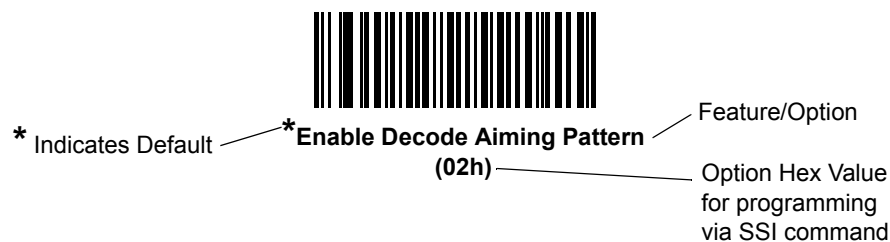

Scanning Sequence Examples

In most cases scanning one bar code sets the parameter value. For example, to disable the decode aiming pattern, scan the **Disable Decode Aiming Pattern** bar code under [Decode Aiming Pattern on page 4-13](#). The digital imager scanner issues a fast warble beep and the LED turns green, signifying a successful parameter entry.

Other parameters require scanning several bar codes. See these parameter descriptions for this procedure.

Errors While Scanning

Unless otherwise specified, to correct an error during a scanning sequence, just re-scan the correct parameter.

Imaging Preferences Parameter Defaults

[Table 5-1](#) lists the defaults for imaging preferences parameters. There are two ways to change the default values:

- Scan the appropriate bar codes in this guide. These new values replace the standard default values in memory. To recall the default parameter values, scan the [Set Default Parameter on page 4-4](#).
- Download data through the device's serial port using SSI. Hexadecimal parameter numbers appear in this chapter below the parameter title, and options appear in parenthesis beneath the accompanying bar codes. See the *Simple Serial Interface (SSI) Programmer's Guide* for detailed instructions for changing parameters using this method.

✓ **NOTE** See [Appendix A, Standard Default Parameters](#) for all user preferences, hosts, symbologies, and miscellaneous default parameters.

Table 5-1 *Imaging Preferences Parameter Defaults*

Parameter	Parameter Number	Default	Page Number
Imaging Preferences			
Operational Modes	N/A	N/A	5-4
Low Light Enhancement	F1h 64h	Disable	5-5
Presentation Mode Field of View	F1h 61h	Default (Reduced)	5-5
Image Capture Autoexposure	F0h 68h	Enable	5-6
Image Capture Illumination	F0h 69h	Enable	5-6
Illumination Bank Control	F1h 3Bh	Full	5-7
Fixed Exposure	F4h F1h 37h	100	5-8
Fixed Gain	F1h 38h	50	5-8
Gain / Exposure Priority for Snapshot Mode	F1h 32h	Autodetect	5-9
Snapshot Mode Timeout	F0h 43h	0 (30 seconds)	5-10

Table 5-1 *Imaging Preferences Parameter Defaults (Continued)*

Parameter	Parameter Number	Default	Page Number
Snapshot Aiming Pattern	F0h 2Ch	Enable	5-10
Image Cropping	F0h 2Dh	Disable	5-11
Crop to Pixel Addresses	F4h F0h 3Bh; F4h F0h 3Ch; F4h F0h 3Dh; F4h F0h 3Eh	0 top, 0 left, 1023 bottom, 1279 right	5-12
Image Size (Number of Pixels)	F0h 2Eh	Full	5-13
Image Brightness (Target White)	F0h 86h	180	5-14
JPEG Image Options	F0h 2Bh	Quality	5-14
JPEG Target File Size	F1h 31h	160 kB	5-15
JPEG Quality and Size Value	F0h 31h	65	5-15
Image Enhancement	F1h 34h	Off (0)	5-16
Image File Format Selection	F0h 30h	JPEG	5-17
Bits per Pixel (BPP)	F0h 2Fh	8 BPP	5-18
Signature Capture	5Dh	Disable	5-19
Signature Capture Image File Format Selection	F0h 39h	JPEG	5-20
Signature Capture Bits per Pixel (BPP)	F0h 3Ah	8 BPP	5-21
Signature Capture Width	F4h F0h 6Eh	400	5-22
Signature Capture Height	F4h F0h 6Fh	100	5-22
Signature Capture JPEG Quality	F0h A5h	65	5-22
Video View Finder	F0h 44h	Disable	5-23
Target Video Frame Size	F0h 48h	2200 bytes	5-23
Video View Finder Image Size	F0h 49h	1700 bytes	5-24

Imaging Preferences

The parameters in this chapter control image capture characteristics. Image capture occurs in all modes of operation, including decode, video, and snapshot.

Operational Modes

The digital imager scanner has three modes of operation:

- Decode Mode
- Snapshot Mode
- Video Mode.

Decode Mode

By default, when you pull the trigger the digital imager scanner attempts to locate and decode enabled bar codes within its field of view. The digital imager scanner remains in this mode until it decodes a bar code or you release the trigger.

Snapshot Mode

Use Snapshot Mode to capture a high-quality image and transmit it to the host. To temporarily enter this mode scan the **Snapshot Mode** bar code. While in this mode the digital imager scanner blinks the green LED at 1-second intervals to indicate it is not in standard operating (decode) mode.

In Snapshot Mode, the digital imager scanner turns on its laser aiming pattern to highlight the area to capture in the image. The next trigger pull instructs the digital imager scanner to capture a high quality image and transmit it to the host. A short time may pass (less than 2 seconds) between when the trigger is pulled and the image is captured as the digital imager scanner adjusts to the lighting conditions. Hold the digital imager scanner steady until the image is captured, denoted by a single beep.

If you do not press the trigger within the Snapshot Mode Timeout period, the digital imager scanner returns to Decode Mode. Use [Snapshot Mode Timeout on page 5-10](#) to adjust this timeout period. The default timeout period is 30 seconds.

To disable the laser aiming pattern during Snapshot Mode, see [Snapshot Aiming Pattern on page 5-10](#).

Video Mode

In this mode the digital imager scanner behaves as a video camera as long as you press the trigger. Release the trigger to return the digital imager scanner to Decode Mode. Scan this bar code to temporarily enter Video Capture Mode.



Snapshot Mode



Video Mode

Low Light Enhancement

Parameter # F1h, 64h

In presentation mode, selecting **Enable Low Light Enhancement** causes illumination to remain on at a low level in low lighting conditions. Select **Disable Low Light Enhancement** to prevent illumination from remaining on under these conditions.



**Enable Low Light Enhancement
(01h)**



***Disable Low Light Enhancement
(00h)**

Presentation Mode Field of View

Parameter # F1h, 61h

In presentation mode, the scanner searches for a bar code in a smaller region around the aiming pattern's center cross to speed search time.

To use a full field of view, scan **Presentation Mode Full Field of View**. This allows the scanner to search the larger area of the aiming pattern.

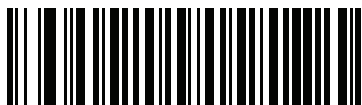

***Presentation Mode Default Field of View
(01h)**



**Presentation Mode Full Field of View
(02h)**

Image Capture Autoexposure

Parameter # F0h, 68h

Select **Enable Image Capture Autoexposure** to allow the digital imager scanner to control gain settings and exposure (integration) time to best capture an image for the selected operation mode.

Select **Disable Image Capture Autoexposure** to manually adjust the gain and exposure time (see the following pages). This option is only recommended for advanced users with difficult image capture situations.

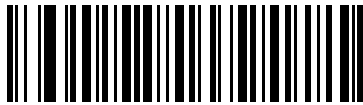

*Enable Image Capture Autoexposure
(01h)

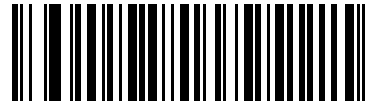

Disable Image Capture Autoexposure
(00h)

Image Capture Illumination

Parameter # F0h, 69h

Selecting **Enable Image Capture Illumination** causes the digital imager scanner to flash on every image capture. Select **Disable Image Capture Illumination** to prevent the digital imager scanner from using artificial illumination.

Enabling illumination usually results in superior images. The effectiveness of the illumination decreases as the distance to the target increases.

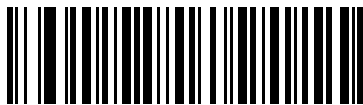

*Enable Image Capture Illumination
(01h)



Disable Image Capture Illumination
(00h)

Illumination Bank Control

Parameter # F1h, 3Bh

This parameter controls the illumination banks on the scan engine. Options are:

- **Full**: Enables the full illumination system (default).
- **Auto**: Switches the illumination system from left to right bank.
- **Left**: Enables the left bank.
- **Right**: Enables the right bank.



***Full**
(00h)



Auto
(01h)



Left
(02h)



Right
(03h)

Fixed Exposure

Parameter #: F4h F1h 37h

Type: Word

Range: 5 - 5000

This parameter configures the exposure used in manual mode for both Decode and Snapshot/Video/Video viewfinder modes.

Each integer value represents 100 μ s worth of exposure. The default value is 100 which results in an exposure setting of 10 ms.

To set the Fixed Exposure parameter, scan **Fixed Exposure** followed by four numeric bar codes representing the value. Leading zeros are required. For example, to set a Fixed Exposure value of 99, scan 0, 0, 9, 9. See [Appendix D, Numeric Bar Codes](#) for numeric bar codes.



Fixed Exposure
(4 digits)

Fixed Gain

Parameter #: F1h 38h

Type: Byte

Range 1 - 100

This parameter configures the gain setting used in manual mode for both Decode and Snapshot/Video/Video viewfinder modes.

A value of 1 indicates that gain is not used for image capture. A value of 100 indicates that maximum gain is used for image capture. The default value of this parameter is 50.

To set the Fixed Gain parameter, scan **Fixed Gain** below followed by three numeric bar codes representing the value. Leading zeros are required. For example, to set a Fixed Gain value of 99, scan 0, 9, 9. See [Appendix D, Numeric Bar Codes](#) for numeric bar codes.



Fixed Gain

Gain/Exposure Priority for Snapshot Mode

Parameter # F1h, 32h

This parameter alters the digital imager scanner's gain exposure priority when it acquires an image in Snapshot Mode in auto exposure mode.

- Scan **Low Exposure Priority** to set a mode in which the digital imager scanner favors higher gain over exposure to capture an image. This results in an image that is less susceptible to motion blur at the expense of noise artifacts. However, for most applications, the amount of noise is acceptable.
- Scan **Low Gain Priority** to set a mode in which the digital imager scanner favors longer exposure time rather than higher gain to capture an image. This ensures that the image is less noisy and produces fewer artifacts during post processing activities like image enhancement (sharpening). The mode is recommended for fixed mount / fixed object image capture since the image acquired is susceptible to motion blur.
- Scan **Autodetect** (default) to set a mode in which the digital imager scanner automatically selects Gain Priority or Low Exposure Priority mode for Snapshot Mode. If the digital imager scanner is in a magnetic read switch enabled stand (or it is configured in Blink Mode), it uses Low Gain Priority mode. Otherwise, it uses the Low Exposure Priority mode.



Low Gain Priority
(0)



Low Exposure Priority
(1)



*** Autodetect**
(2)

Snapshot Mode Timeout

Parameter # F0h, 43h

This parameter sets the amount of time the digital imager scanner remains in Snapshot Mode. The digital imager scanner exits Snapshot Mode when you pull the trigger, or when the Snapshot Mode Timeout elapses. To set this timeout value, scan the bar code below followed by a bar code from [Appendix D, Numeric Bar Codes](#). The default value is 0 which represents 30 seconds; values increment by 30. For example, 1 = 60 seconds, 2 = 90 seconds, etc.



Snapshot Mode Timeout

Snapshot Aiming Pattern

Parameter # F0h, 2Ch

Select **Enable Snapshot Aiming Pattern** to project the aiming pattern when in Snapshot Mode, or **Disable Snapshot Aiming Pattern** to turn the aiming pattern off.



*Enable Snapshot Aiming Pattern
(01h)



Disable Snapshot Aiming Pattern
(00h)

Image Cropping

Parameter # F0h, 2Dh

This parameter crops a captured image. Select **Disable Image Cropping** to present the full 1280 x 1024 pixels. Select **Enable Image Cropping** to crop the image to the pixel addresses set in [Crop to Pixel Addresses on page 5-12](#).



NOTE The digital scanner has a cropping resolution of 4 pixels. Setting the cropping area to less than 3 pixels transfers the entire image.



Enable Image Cropping
(01h)



*Disable Image Cropping
(Use Full 1280 x 1024 Pixels)
(00h)

Crop to Pixel Addresses

Parameter # F4h, F0h, 3Bh (Top)

Parameter # F4h, F0h, 3Ch (Left)

Parameter # F4h, F0h, 3Dh (Bottom)

Parameter # F4h, F0h, 3Eh (Right)

If you selected **Enable Image Cropping**, set the pixel addresses from (0,0) to (1279,1023) to crop to.

Columns are numbered from 0 to 1279, rows from 0 to 1023. Specify four values for Top, Left, Bottom, and Right, where Top and Bottom correspond to row pixel addresses, and Left and Right correspond to column pixel addresses. For example, for a 4 row x 8 column image in the extreme bottom-right section of the image set the following values:

Top = 1020, Bottom = 1023, Left = 1272, Right = 1279

To set the crop to pixel address, scan each pixel address bar code below followed by four numeric bar codes representing the value. Leading zeros are required. For example, to crop the top pixel address to 3, scan 0, 0, 0, 3. See [Appendix D, Numeric Bar Codes](#) for numeric bar codes.



Top Pixel Address
(0 - 1023 Decimal)



Left Pixel Address
(0 - 1279 Decimal)



Bottom Pixel Address
(0 - 1023 Decimal)



Right Pixel Address
(0 - 1279 Decimal)

Image Size (Number of Pixels)

Parameter # F0h, 2Eh

This option alters image resolution before compression. Multiple pixels are combined to one pixel, resulting in a smaller image containing the original content with reduced resolution.

Select one of the following values:

Resolution Value	Uncropped Image Size
Full	1280 x 1024
1/2	640 x 512
1/4	320 x 160



*Full Resolution
(00h)



1/2 Resolution
(01h)



1/4 Resolution
(03h)

Image Brightness (Target White)

Parameter # F0h 86h

Type: Byte

Range: 1 - 240

This parameter sets the Target White value used in Snapshot, Video and Video Viewfinder mode when using auto exposure. White and black are defined as 255 decimal and 0, respectively. Setting the value to the factory default of 180 sets the white level of the image to ~180.

To set the Image Brightness parameter, scan **Image Brightness** below followed by three numeric bar codes representing the value. Leading zeros are required. For example, to set an Image Brightness value of 99, scan 0, 9, 9. See [Appendix D, Numeric Bar Codes](#) for numeric bar codes.



*180



Image Brightness
(3 digits)

JPEG Image Options

Parameter # F0h, 2Bh

Select an option to optimize JPEG images for either size or for quality. Scan the **JPEG Quality Selector** bar code to enter a quality value; the digital imager scanner then selects the corresponding image size. Scan the **JPEG Size Selector** bar code to enter a size value; the digital imager scanner then selects the best image quality.



*JPEG Quality Selector
(01h)



JPEG Size Selector
(00h)

JPEG Target File Size

Parameter # F4h, F1h, 31h

Type: Word

Range: 5-600

This parameter defines the target JPEG file size in terms 1 Kilobytes (1024 bytes). The default value is 160 kB which represents 160 Kilobytes.



CAUTION JPEG compress may take 10 to 15 seconds based on the amount of information in the target image. Scanning **JPEG Quality Selector** (default setting) on [page 5-14](#) produces a compressed image that is consistent in quality and compression time.

To set the JPEG Target File Size parameter, scan **JPEG Target File Size** below followed by three numeric bar codes representing the value. Leading zeros are required. For example, to set an Image Brightness value of 99, scan 0, 9, 9 in [Appendix D, Numeric Bar Codes](#).



* JPEG Target File Size
(3 digits)

JPEG Quality and Size Value

JPEG Quality = Parameter # F0h, 31h

If you selected **JPEG Quality Selector**, scan the **JPEG Quality Value** bar code followed by 3 bar codes from [Appendix D, Numeric Bar Codes](#) corresponding to a value from 5 to 100, where 100 represents the highest quality image.



JPEG Quality Value
(Default: 065)
(5 - 100 Decimal)

Image Enhancement

Parameter # F1h, 34h

This parameter configures the digital imager scanner's Image Enhance feature. This feature uses a combination of edge sharpening and contrast enhancement to produce an image that is visually pleasing.

The levels of image enhancement are:

- Off (0) - Default
- Low(1)
- Med(2)
- High(3).



Image File Format Selector

Parameter # F0h, 30h

Select an image format appropriate for the system (BMP, TIFF, or JPEG). The digital imager scanner stores captured images in the selected format.



**BMP File Format
(03h)**



***JPEG File Format
(01h)**



**TIFF File Format
(04h)**

Bits Per Pixel

Parameter # F0h, 2Fh

Select the number of significant bits per pixel (BPP) to use when capturing an image. Select **1 BPP** for a black and white image, **4 BPP** to assign 1 of 16 levels of grey to each pixel, or **8 BPP** to assign 1 of 256 levels of grey to each pixel.



NOTE The digital imager scanner ignores these settings for JPEG file formats, which only support **8 BPP**.

The digital imager scanner ignores 1 BPP for TIFF file formats, which only support **4 BPP** and **8 BPP**. 1 BPP is coerced to 4 BPP for TIFF file formats.



1 BPP
(00h)



4 BPP
(01h)



***8 BPP**
(02h)

Signature Capture

Parameter # 5Dh

A signature capture bar code is a special-purpose symbology which delineates a signature capture area in a document with a machine-readable format. The recognition pattern is variable so it can optionally provide an index to various signatures. The region inside the bar code pattern is considered the signature capture area.

Output File Format

Decoding a signature capture bar code de-skews the signature image and converts the image to a BMP, JPEG, or TIFF file format. The output data includes the file descriptor followed by the formatted signature image.

File Descriptor			Signature Image
Output Format (1 byte)	Signature Type (1 byte)	Signature Image Size (4 bytes) (BIG Endian)	
JPEG - 1	1-8	0x00000400	0x00010203....
BMP - 3			
TIFF - 4			

To enable or disable Signature Capture, scan the appropriate bar code below.



Enable Signature Capture
(01h)



*Disable Signature Capture
(00h)

Signature Capture File Format Selector

Parameter # F0h, 39h

Select a signature file format appropriate for the system (BMP, TIFF, or JPEG). The digital imager scanner stores captured signatures in the selected format.



**BMP Signature Format
(03h)**



***JPEG Signature Format
(01h)**



**TIFF Signature Format
(04h)**

Signature Capture Bits Per Pixel

Parameter # F0h, 3Ah

Select the number of significant bits per pixel (BPP) to use when capturing a signature. Select **1 BPP** for a black and white image, **4 BPP** to assign 1 of 16 levels of grey to each pixel, or **8 BPP** to assign 1 of 256 levels of grey to each pixel.



NOTE The digital imager scanner ignores these settings for JPEG file formats, which only support **8 BPP**.

The digital imager scanner ignores 1 BPP for TIFF file formats, which only support **4 BPP** and **8 BPP**. 1 BPP is coerced to 4 BPP for TIFF file formats.



1 BPP
(00h)



4 BPP
(01h)



***8 BPP**
(02h)

Signature Capture Width

Parameter # F4h, F0h, 6Eh

The aspect ratio of the Signature Capture Width and Signature Capture Height parameters must match that of the signature capture area. For example, a 4 x 1 inch signature capture area would require a 4 to 1 aspect ratio of width to height.

To set the width of the signature capture box, scan the **Signature Capture Width** bar code, followed by 3 bar codes from [Appendix D, Numeric Bar Codes](#) corresponding to a value in the range of 001 to 640 decimal.



Signature Capture Width
(Default: 400)
(001 - 640 Decimal)

Signature Capture Height

Parameter # F4h, F0h, 6Fh

To set the height of the signature capture box, scan the **Signature Capture Height** bar code, followed by 3 bar codes from [Appendix D, Numeric Bar Codes](#) corresponding to a value in the range of 001 to 480 decimal.



Signature Capture Height (Default: 100)
(001 - 480 Decimal)

Signature Capture JPEG Quality

Parameter # F0h, A5h

Scan the **JPEG Quality Value** bar code followed by 3 bar codes from [Appendix D, Numeric Bar Codes](#) corresponding to a value from 005 to 100, where 100 represents the highest quality image.



JPEG Quality Value (Default: 065)
(5 - 100 Decimal)

Video View Finder

Parameter # F0h, 44h

Select **Enable Video View Finder** to project the video view finder while in Video Mode, or **Disable Video View Finder** to turn the video view finder off.

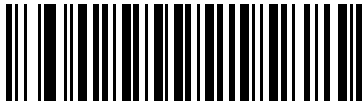

*Disable Video View Finder
(00h)

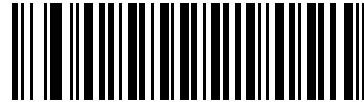

Enable Video View Finder
(01h)

Target Video Frame Size

Parameter # F0h, 48h

Select the number of 100-byte blocks to transmit per second. Selecting a smaller value transmits more frames per second but reduces video quality; selecting a larger value increases video quality but slows transmission.

To set the Target Video Frame Size, scan the bar code below followed by two bar codes from [Appendix D, Numeric Bar Codes](#) corresponding to the 100-byte value from 800 to 3300 bytes. For example, to select 1500 bytes, enter 1, 5. To select 900 bytes, enter 0, 9.



Target Video Frame Size

Video View Finder Image Size

Parameter # F0h, 49h

Select the number of 100-byte blocks. Values range from 800 to 3000 bytes. Selecting a smaller value transmits more frames per second; selecting a larger value increases video quality.

To set the Video View Finder Image Size, scan the bar code below followed by two bar codes from [Appendix D, Numeric Bar Codes](#) corresponding to the 100-byte value from 800 to 3000 bytes. For example, to select 1500 bytes, enter 1, 5. To select 900 bytes, enter 0, 9.



Video View Finder Image Size

Chapter 6 SSI Interface

Introduction

This chapter describes how to set up the digital imager scanner with a Simple Serial Interface (SSI) host. When using SSI, program the digital imager scanner via bar code menu or SSI host commands.

Throughout the programming bar code menus, default values are indicated with asterisks (*).

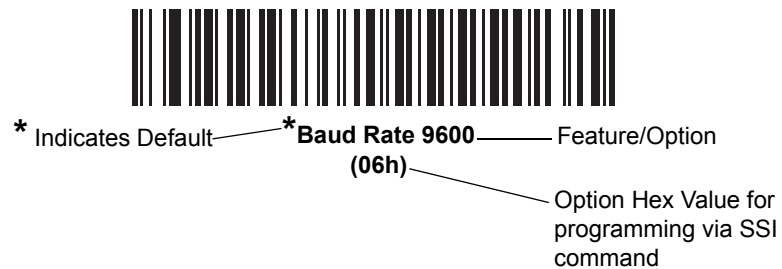

NOTE Most computer monitors allow scanning the bar codes directly on the screen. When scanning from the screen, be sure to set the document magnification to a level where you can see the bar code clearly, and bars and/or spaces are not merging.

Connecting Using Simple Serial Interface

Connect the digital imager scanner to an SSI host.

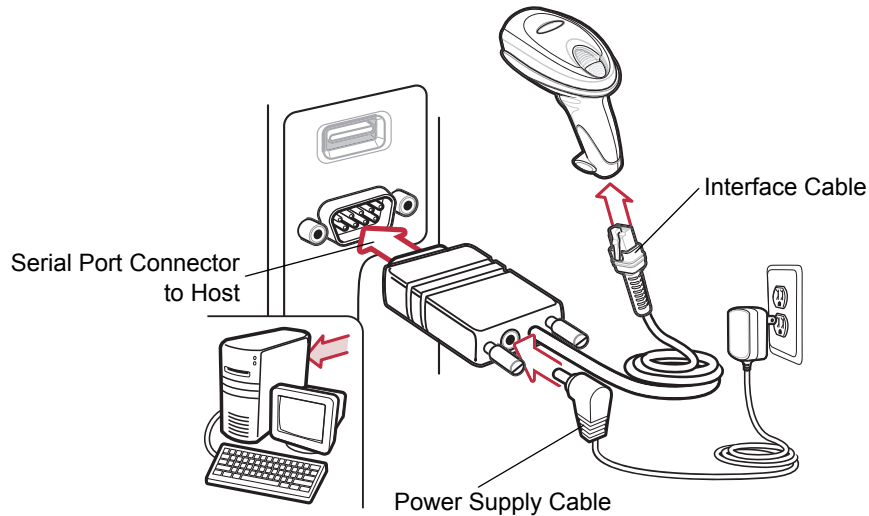

Figure 6-1 SSI Host Connection

1. Attach the modular connector of the interface cable to the cable interface port on the digital imager scanner (see [Installing the Interface Cable on page 1-3](#)).
2. Connect the other end of the interface cable to the serial port on the host.
3. Connect the power supply to the serial connector end of the interface cable. Plug the power supply into an appropriate outlet.
4. Scan the appropriate baud rate bar code from [Baud Rate on page 6-4](#) that matches the host's baud rate setting.
5. To modify any other parameter options, scan the appropriate bar codes in this chapter.

Simple Serial Interface Default Parameters

[Table 6-1](#) lists the defaults for the SSI host. There are two ways to change the default values:

- Scan the appropriate bar codes in this guide. These new values replace the standard default values in memory. To recall the default parameter values, scan the [Set Default Parameter on page 4-4](#).
- Download data through the device's serial port using SSI. Hexadecimal parameter numbers appear in this chapter below the parameter title, and options appear in parenthesis beneath the accompanying bar codes. See the *Simple Serial Interface (SSI) Programmer's Guide* for detailed instructions for changing parameters using this method.

✓ **NOTE** See [Appendix A, Standard Default Parameters](#) for all user preferences, hosts, symbologies, and miscellaneous default parameters.

Table 6-1 SSI Interface Parameter Defaults

Parameter	Parameter Number	Default	Page Number
Baud Rate	9Ch	9600	6-4
Parity	9Eh	None	6-6
Check Parity	97h	Enable	6-7
Software Handshaking	9Fh	ACK/NAK	6-7
Host RTS Line State	9Ah	Low	6-8
Decode Data Packet Format	EEh	Send Raw Decode Data	6-8
Stop Bits	9Dh	1	6-9
Host Serial Response Time-out	9Bh	2 sec	6-10
Host Character Time-out	EFh	200 msec	6-11
Multipacket Option	F0h 4Eh	Option 1	6-12
Interpacket Delay	F0h 4Fh	0 ms	6-13
Event Reporting			
Decode Event	F0h 00h	Disable	6-14
Boot Up Event	F0h 02h	Disable	6-15
Parameter Event	F0h 03h	Disable	6-15

✓ **NOTE** SSI interprets Prefix, Suffix1, and Suffix2 values listed in [Table A-1 on page A-1](#) differently than other interfaces. SSI does not recognize key categories, only the 3-digit decimal value. The default value of 7013 is interpreted as CR only.

SSI Host Parameters

Baud Rate

Parameter # 9Ch

Baud rate is the number of bits of data transmitted per second. Set the digital imager scanner's baud rate to match the data rate setting of the host device. Otherwise, data may not reach the host or may reach it in distorted form.

To enable the SSI host, scan the appropriate baud rate bar code that matches the baud rate setting of the host device.



**Baud Rate 600
(02h)**



**Baud Rate 1200
(03h)**



**Baud Rate 2400
(04h)**



**Baud Rate 4800
(05h)**



***Baud Rate 9600
(06h)**

Baud Rate (continued)



**Baud Rate 19,200
(07h)**



**38,400
(08h)**



**57,600
(0Ah)**



**115,200
(0Bh)**



**230,400
(0Ch)**

Parity

Parameter # 9Eh

A parity check bit is the most significant bit of each ASCII coded character. Select the parity type according to host device requirements.

- Select **Odd** parity to set the parity bit to a value 0 or 1, based on data, to ensure that the coded character contains an odd number of 1 bits.
- Select **Even** parity to set the parity bit to a value 0 or 1, based on data, to ensure that the coded character contains an even number of 1 bits.
- If no parity is required, select **None**.



Odd
(00h)



Even
(01h)



***None**
(04h)

Check Parity

Parameter # 97h

Select whether or not to check the parity of received characters. Use the Parity parameter to select the type of parity.



***Check Parity
(01h)**



**Do Not Check Parity
(00h)**

Software Handshaking

Parameter # 9Fh

This parameter offers control of the data transmission process in addition to that offered by hardware handshaking. Hardware handshaking is always enabled and cannot be disabled by the user.

- **Disable ACK/NAK Handshaking:** If you select this option, the decoder neither generates nor expects ACK/NAK handshaking packets.
- **Enable ACK/NAK Handshaking:** If you select this option, after transmitting data, the digital imager scanner expects either an ACK or NAK response from the host. The digital imager scanner also ACKs or NAKs messages from the host.

The digital imager scanner waits up to the programmable Host Serial Response Time-out to receive an ACK or NAK. If the scanner does not get a response in this time, it resends its data up to two times before discarding the data and declaring a transmit error.



**Disable ACK/NAK
(00h)**



***Enable ACK/NAK
(01h)**

Host RTS Line State

Parameter # 9Ah

This parameter sets the expected idle state of the Serial Host RTS line.

The SSI Interface is used with host applications which also implement the SSI protocol. However, you can also use the digital imager scanner in a "scan-and-transmit" mode to communicate with any standard serial communication software on a host PC (see [Decode Data Packet Format on page 6-8](#)). If transmission errors occur in this mode, the host PC may be asserting hardware handshaking lines which interfere with the SSI protocol. Scan the **Host: RTS High** bar code to address this problem.



*Host: RTS Low
(00h)



Host: RTS High
(01h)

Decode Data Packet Format

Parameter # EEh

This parameter selects whether to transmit decoded data in raw format (unpacked), or with the packet format defined by the serial protocol.

Selecting the raw format disables ACK/NAK handshaking for decode data.



*Send Raw Decode Data
(00h)



Send Packeted Decode Data
(01h)

Stop Bit Select

Parameter # 9Dh

The stop bit(s) at the end of each transmitted character marks the end of transmission of one character and prepares the receiving (host) device for the next character in the serial data stream. Set the number of stop bits (one or two) to match host device requirements.



*1 Stop Bit
(01h)



2 Stop Bits
(02h)

Host Serial Response Time-out

Parameter # 9Bh

This parameter specifies how long the decoder waits for an ACK or NAK before resending. Also, if the decoder wants to send, and the host was already granted permission to send, the decoder waits for the designated time-out before declaring an error.

To set the delay period (options are 2, 5, 7.5, or 9.9 seconds), scan one of the following bar codes.

✓ **NOTE** Other values are available via SSI command.



***Low - 2 Seconds
(14h)**



**Medium - 5 Seconds
(32h)**



**High - 7.5 Seconds
(4Bh)**



**Maximum - 9.9 Seconds
(63h)**

Host Character Time-out

Parameter # EFh

This parameter determines the maximum time the decoder waits between characters transmitted by the host before discarding the received data and declaring an error.

To set the delay period (options are 200, 500, 750, or 990 ms), scan one of the following bar codes.

✓ **NOTE** Other values are available via SSI command.



*Low - 200 ms
(0Ah)



Medium - 500 ms
(32h)



High - 750 ms
(4Bh)



Maximum - 990 ms
(63h)

Multipacket Option

Parameter # F0h, 4Eh

This parameter controls ACK/NAK handshaking for multi-packet transmissions.

- **Multi-Packet Option 1:** The host sends an ACK / NAK for each data packet during a multi-packet transmission.
- **Multi-Packet Option 2:** The digital imager scanner sends data packets continuously, with no ACK/NAK handshaking to pace the transmission. The host, if overrun, can use hardware handshaking to temporarily delay digital imager scanner transmissions. At the end of transmission, the digital imager scanner waits for a CMD_ACK or CMD_NAK.
- **Multi-Packet Option 3:** Option 3 is the same as option 2 with the addition of a programmable interpacket delay.



*Multipacket Option 1
(00h)



Multipacket Option 2
(01h)



Multipacket Option 3
(02h)

Interpacket Delay

Parameter # F0h, 4Fh

This parameter specifies the interpacket delay when **Multipacket Option 3** is selected.

To set the delay period (options are 0, 25, 50, 75, or 99 ms), scan one of the following bar codes.

✓ **NOTE** Other values are available via SSI command.



*Minimum - 0 ms
(00h)



Low - 25 ms
(19h)



Medium - 50 ms
(32h)



High - 75 ms
(4Bh)



Maximum - 99 ms
(63h)

Event Reporting

The host can request the digital imager scanner to provide certain information (events) relative to the digital imager scanner's behavior. Enable or disable the events listed in [Table 6-2](#) and on the following pages by scanning the appropriate bar codes.

Table 6-2 *Event Codes*

Event Class	Event	Code Reported
Decode Event	Non parameter decode	0x01
Boot Up Event	System power-up	0x03
Parameter Event	Parameter entry error	0x07
	Parameter stored	0x08
	Defaults set (and parameter event is enabled by default)	0x0A
	Number expected	0x0F

Decode Event

Parameter # F0h, 00h

When enabled, the digital imager scanner generates a message to the host when it successfully decodes a bar code. When disabled, no notification is sent.

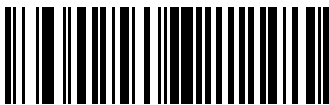

**Enable Decode Event
(01h)**

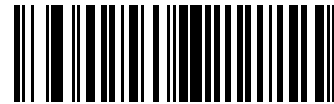

***Disable Decode Event
(00h)**

Boot Up Event

Parameter # F0h, 02h

When enabled, the digital imager scanner generates a message to the host when power is applied. When disabled, no notification is sent.

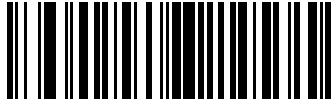

Enable Boot Up Event
(01h)



*Disable Boot Up Event
(00h)

Parameter Event

Parameter # F0h, 03h

When enabled, the digital imager scanner generates a message to the host when one of the events specified in [Table 6-2 on page 6-14](#) occurs. When disabled, no notification is sent.

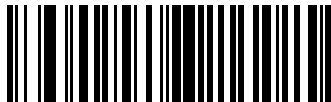

Enable Parameter Event
(01h)



*Disable Parameter Event
(00h)

Chapter 7 USB Interface

Introduction

This chapter describes how to set up the digital imager scanner with a USB host. The digital imager scanner connects directly to a USB host, or a powered USB hub, which powers it. No additional power supply is required.

Throughout the programming bar code menus, asterisks (*) indicate default values.



*Indicates Default — *North American Standard USB Keyboard — Feature/Option



NOTE Most computer monitors allow scanning the bar codes directly on the screen. When scanning from the screen, be sure to set the document magnification to a level where you can see the bar code clearly, and bars and/or spaces are not merging.

Connecting a USB Interface

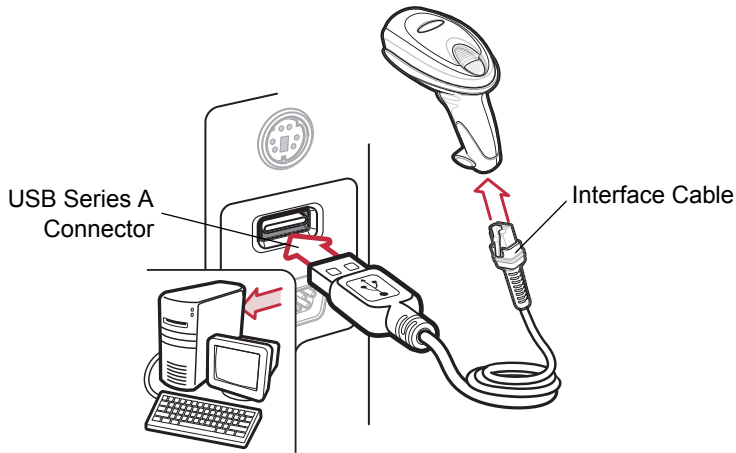

Figure 7-1 *USB Connection*

The digital imager scanner connects with USB-capable hosts including:

- Desktop PCs and notebooks
 - Apple™ iMac, G4, iBooks (North America only)
 - IBM SurePOS terminals
- Sun, IBM, and other network computers that support more than one keyboard.

The following operating systems support the digital imager scanner through USB:

- Windows® 98, 2000, ME, XP
- MacOS 8.5 - MacOS 10.3
- IBM 4690 OS.

The digital imager scanner also interfaces with other USB hosts which support USB Human Interface Devices (HID). For more information on USB technology, hosts, and peripheral devices, visit www.symbol.com/usb.

To set up the digital imager scanner:

✓ **NOTE** Interface cables vary depending on configuration. The connectors illustrated in [Figure 7-1](#) are examples only. The connectors may be different than those illustrated, but the steps to connect the scanner are the same.

1. Connect the modular connector of the USB interface cable to the cable interface port on the digital imager scanner (see [Installing the Interface Cable on page 1-3](#)).
2. Plug the series A connector in the USB host or hub, or plug the Plus Power connector in an available port of the IBM SurePOS terminal.
3. Select the USB device type by scanning the appropriate bar code from [USB Device Type on page 7-4](#).
4. On first installation when using Windows, the software prompts to select or install the Human Interface Device driver. To install this driver, provided by Windows, click **Next** through all the choices and click **Finished** on the last choice. The digital imager scanner powers up during this installation.
5. To modify any other parameter options, scan the appropriate bar codes in this chapter.

If problems occur with the system, see [Troubleshooting on page 3-2](#).

USB Parameter Defaults

Table 7-1 lists the defaults for USB host parameters. To change an option, scan the appropriate bar code(s) provided in the Parameter Descriptions section beginning on [page 7-4](#).

✓ **NOTE** See [Appendix A, Standard Default Parameters](#) for all user preferences, hosts, symbologies, and miscellaneous default parameters.

Table 7-1 *USB Interface Parameter Defaults*

Parameter	Default	Page Number
USB Host Parameters		
USB Device Type	HID Keyboard Emulation	7-4
Symbol Native API (SNAPI) Status Handshaking	Enable	7-5
USB Country Keyboard Types (Country Codes)	North American	7-6
USB Keystroke Delay	No Delay	7-8
USB CAPS Lock Override	Disable	7-8
USB Ignore Unknown Characters	Enable	7-9
Emulate Keypad	Disable	7-9
Emulate Keypad with Leading Zero	Disable	7-10
USB FN1 Substitution	Disable	7-10
Function Key Mapping	Disable	7-11
Simulated Caps Lock	Disable	7-11
Convert Case	No Case Conversion	7-12

USB Host Parameters

USB Device Type

Select the desired USB device type.



NOTE When changing USB Device Types, the digital imager scanner automatically resets and issues the standard startup beep sequences.

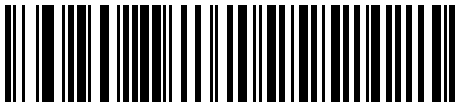

*HID Keyboard Emulation



IBM Table Top USB

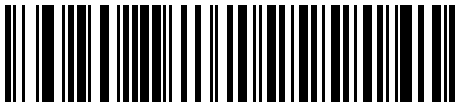

IBM Hand-Held USB



USB OPOS Handheld



Simple COM Port Emulation

USB Device Type (continued)



Symbol Native API (SNAPI) with Imaging Interface



Symbol Native API (SNAPI) without Imaging Interface

Symbol Native API (SNAPI) Status Handshaking

After selecting a SNAPI interface as the USB device type, select whether to enable or disable status handshaking.



*Enable SNAPI Status Handshaking



Disable SNAPI Status Handshaking

USB Country Keyboard Types (Country Codes)

Scan the bar code corresponding to the keyboard type. This setting applies only to the USB HID Keyboard Emulation device.

✓ **NOTE** When changing USB country keyboard types the digital imager scanner automatically resets and issues the standard startup beep sequences.

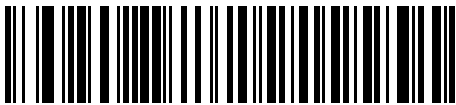

*North American Standard USB Keyboard

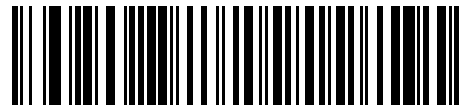

German Windows

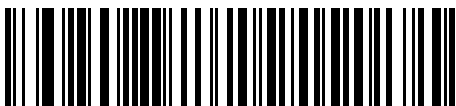

French Windows

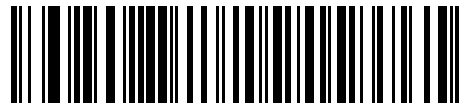

French Canadian Windows 95/98



French Canadian Windows 2000/XP

USB Country Keyboard Types (continued)



Spanish Windows

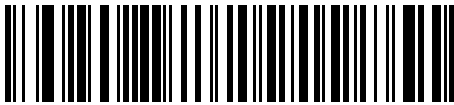

Italian Windows



Swedish Windows

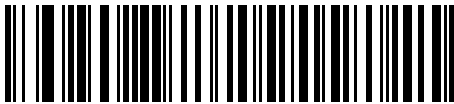

UK English Windows



Japanese Windows (ASCII)

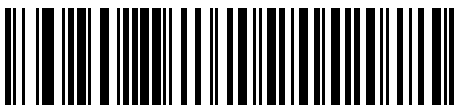

Portuguese-Brazilian Windows

USB Keystroke Delay

This parameter sets the delay, in milliseconds, between emulated keystrokes. Scan a bar code below to increase the delay when hosts require slower data transmission.

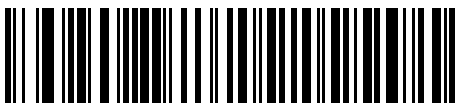

*No Delay



Medium Delay (20 msec)

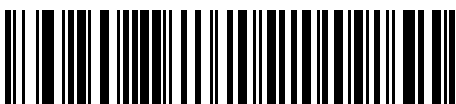

Long Delay (40 msec)

USB CAPS Lock Override

This option applies only to the HID Keyboard Emulation device. Enable this to preserve the case of the data regardless of the state of the **Caps Lock** key. This setting is always enabled for the Japanese, Windows (ASCII) keyboard type and can not be disabled.



Override Caps Lock Key
(Enable)



*Do Not Override Caps Lock Key
(Disable)

USB Ignore Unknown Characters

This option applies only to the HID Keyboard Emulation device and IBM device. Unknown characters are characters the host does not recognize. Select **Send Bar Codes With Unknown Characters** to send all bar code data except for unknown characters. The scanner sounds no error beeps.

If you select **Do Not Send Bar Codes With Unknown Characters**, for IBM devices, bar codes containing at least one unknown character are not sent to the host, and the scanner sounds an error beep. For HID Keyboard Emulation devices, the bar code characters up to the unknown character are sent, and the scanner sounds an error beep.

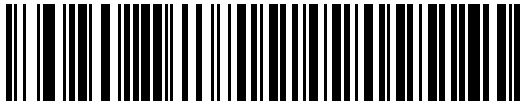

***Send Bar Codes with Unknown Characters
(Transmit)**

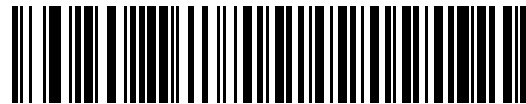

**Do Not Send Bar Codes with Unknown Characters
(Disable)**

Emulate Keypad

Enable this to send all characters as ASCII sequences over the numeric keypad. For example ASCII A transmits as "ALT make" 0 6 5 "ALT Break".



***Disable Keypad Emulation**

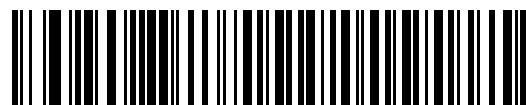

Enable Keypad Emulation

Emulate Keypad with Leading Zero

Enable this to send character sequences sent over the numeric keypad as ISO characters which have a leading zero. For example ASCII A transmits as "ALT MAKE" 0 0 6 5 "ALT BREAK".



*Disable Keypad Emulation with Leading Zero



Enable Keypad Emulation with Leading Zero

USB Keyboard FN 1 Substitution

This option applies only to the USB HID Keyboard Emulation device. Enable this to replace any FN 1 characters in a GS1-128 bar code with a user-selected Key Category and value (see [FN1 Substitution Values on page 4-18](#) to set the Key Category and Key Value).

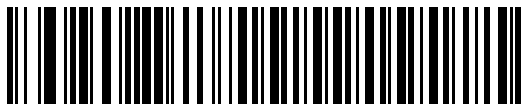

Enable



*Disable

Function Key Mapping

ASCII values under 32 are normally sent as a control-key sequences (see [Table 7-2 on page 7-13](#)). Enable this to send the keys in bold in place of the standard key mapping. Table entries that do not have a bold entry remain the same whether or not you enable this parameter.

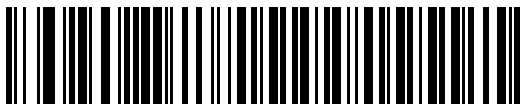

*Disable Function Key Mapping



Enable Function Key Mapping

Simulated Caps Lock

Enable this to invert upper and lower case characters on the bar code as if the Caps Lock state is enabled on the keyboard. This inversion occurs regardless of the state of the keyboard's **Caps Lock** key.



*Disable Simulated Caps Lock

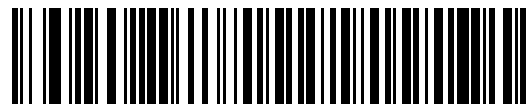

Enable Simulated Caps Lock

Convert Case

Enable this to convert all bar code data to the selected case.



***No Case Conversion**

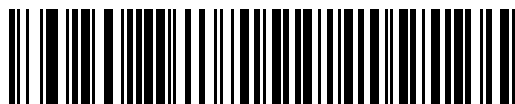

Convert All to Upper Case



Convert All to Lower Case

ASCII Character Set for USB

Table 7-2 USB Prefix/Suffix Values

Prefix/ Suffix Value	Full ASCII Code 39 Encode Character	Keystroke
1000	%U	CTRL 2
1001	\$A	CTRL A
1002	\$B	CTRL B
1003	\$C	CTRL C
1004	\$D	CTRL D
1005	\$E	CTRL E
1006	\$F	CTRL F
1007	\$G	CTRL G
1008	\$H	CTRL H/ BACKSPACE ¹
1009	\$I	CTRL I/ HORIZONTAL TAB ¹
1010	\$J	CTRL J
1011	\$K	CTRL K
1012	\$L	CTRL L
1013	\$M	CTRL M/ ENTER ¹
1014	\$N	CTRL N
1015	\$O	CTRL O
1016	\$P	CTRL P
1017	\$Q	CTRL Q
1018	\$R	CTRL R
1019	\$S	CTRL S
1020	\$T	CTRL T
1021	\$U	CTRL U
1022	\$V	CTRL V
1023	\$W	CTRL W
1024	\$X	CTRL X

¹The keystroke in bold transmits only if you enabled *Function Key Mapping* on page 7-11. Otherwise, the unbolded keystroke transmits.

Table 7-2 USB Prefix/Suffix Values (Continued)

Prefix/ Suffix Value	Full ASCII Code 39 Encode Character	Keystroke
1025	\$Y	CTRL Y
1026	\$Z	CTRL Z
1027	%A	CTRL [/ ESC ¹
1028	%B	CTRL \
1029	%C	CTRL]
1030	%D	CTRL 6
1031	%E	CTRL -
1032	Space	Space
1033	/A	!
1034	/B	"
1035	/C	#
1036	/D	\$
1037	/E	%
1038	/F	&
1039	/G	'
1040	/H	(
1041	/I)
1042	/J	*
1043	/K	+
1044	/L	,
1045	-	-
1046	.	.
1047	/O	/
1048	0	0
1049	1	1
1050	2	2
1051	3	3
1052	4	4

¹The keystroke in bold transmits only if you enabled *Function Key Mapping* on page 7-11. Otherwise, the unbolded keystroke transmits.

Table 7-2 USB Prefix/Suffix Values (Continued)

Prefix/ Suffix Value	Full ASCII Code 39 Encode Character	Keystroke
1053	5	5
1054	6	6
1055	7	7
1056	8	8
1057	9	9
1058	/Z	:
1059	%F	;
1060	%G	<
1061	%H	=
1062	%I	>
1063	%J	?
1064	%V	@
1065	A	A
1066	B	B
1067	C	C
1068	D	D
1069	E	E
1070	F	F
1071	G	G
1072	H	H
1073	I	I
1074	J	J
1075	K	K
1076	L	L
1077	M	M
1078	N	N
1079	O	O
1080	P	P

¹The keystroke in bold transmits only if you enabled *Function Key Mapping* on page 7-11. Otherwise, the unbolded keystroke transmits.

Table 7-2 USB Prefix/Suffix Values (Continued)

Prefix/ Suffix Value	Full ASCII Code 39 Encode Character	Keystroke
1081	Q	Q
1082	R	R
1083	S	S
1084	T	T
1085	U	U
1086	V	V
1087	W	W
1088	X	X
1089	Y	Y
1090	Z	Z
1091	%K	[
1092	%L	\
1093	%M]
1094	%N	^
1095	%O	_
1096	%W	`
1097	+A	a
1098	+B	b
1099	+C	c
1100	+D	d
1101	+E	e
1102	+F	f
1103	+G	g
1104	+H	h
1105	+I	i
1106	+J	j
1107	+K	k
1108	+L	l

¹The keystroke in bold transmits only if you enabled *Function Key Mapping* on page 7-11. Otherwise, the unbolded keystroke transmits.

Table 7-2 USB Prefix/Suffix Values (Continued)

Prefix/ Suffix Value	Full ASCII Code 39 Encode Character	Keystroke
1109	+M	m
1110	+N	n
1111	+O	o
1112	+P	p
1113	+Q	q
1114	+R	r
1115	+S	s
1116	+T	t
1117	+U	u
1118	+V	v
1119	+W	w
1120	+X	x
1121	+Y	y
1122	+Z	z
1123	%P	{
1124	%Q	
1125	%R	}
1126	%S	~

¹The keystroke in bold transmits only if you enabled *Function Key Mapping* on page 7-11. Otherwise, the unbolded keystroke transmits.

Table 7-3 USB ALT Key Character Set

ALT Keys	Keystroke
2064	ALT 2
2065	ALT A
2066	ALT B
2067	ALT C
2068	ALT D
2069	ALT E
2070	ALT F
2071	ALT G

Table 7-3 USB ALT Key Character Set (Continued)

ALT Keys	Keystroke
2072	ALT H
2073	ALT I
2074	ALT J
2075	ALT K
2076	ALT L
2077	ALT M
2078	ALT N
2079	ALT O
2080	ALT P
2081	ALT Q
2082	ALT R
2083	ALT S
2084	ALT T
2085	ALT U
2086	ALT V
2087	ALT W
2088	ALT X
2089	ALT Y
2090	ALT Z

Table 7-4 USB GUI Key Character Set

GUI Key	Keystroke
3000	Right Control Key
3048	GUI 0
3049	GUI 1
3050	GUI 2
3051	GUI 3
3052	GUI 4
3053	GUI 5

Note: GUI Shift Keys - The Apple™ iMac keyboard has an apple key on either side of the space bar. Windows-based systems have a GUI key to the left of the left ALT key, and to the right of the right ALT key.

Table 7-4 USB GUI Key Character Set (Continued)

GUI Key	Keystroke
3054	GUI 6
3055	GUI 7
3056	GUI 8
3057	GUI 9
3065	GUI A
3066	GUI B
3067	GUI C
3068	GUI D
3069	GUI E
3070	GUI F
3071	GUI G
3072	GUI H
3073	GUI I
3074	GUI J
3075	GUI K
3076	GUI L
3077	GUI M
3078	GUI N
3079	GUI O
3080	GUI P
3081	GUI Q
3082	GUI R
3083	GUI S
3084	GUI T
3085	GUI U
3086	GUI V
3087	GUI W

Note: GUI Shift Keys - The Apple™ iMac keyboard has an apple key on either side of the space bar. Windows-based systems have a GUI key to the left of the left ALT key, and to the right of the right ALT key.

Table 7-4 USB GUI Key Character Set (Continued)

GUI Key	Keystroke
3088	GUI X
3089	GUI Y
3090	GUI Z

Note: GUI Shift Keys - The Apple™ iMac keyboard has an apple key on either side of the space bar. Windows-based systems have a GUI key to the left of the left ALT key, and to the right of the right ALT key.

Table 7-5 USB F Key Character Set

F Keys	Keystroke
5001	F1
5002	F2
5003	F3
5004	F4
5005	F5
5006	F6
5007	F7
5008	F8
5009	F9
5010	F10
5011	F11
5012	F12
5013	F13
5014	F14
5015	F15
5016	F16
5017	F17
5018	F18
5019	F19
5020	F20
5021	F21

Table 7-5 *USB F Key Character Set (Continued)*

F Keys	Keystroke
5022	F22
5023	F23
5024	F24

Table 7-6 *USB Numeric Keypad Character Set*

Numeric Keypad	Keystroke
6042	*
6043	+
6044	undefined
6045	-
6046	.
6047	/
6048	0
6049	1
6050	2
6051	3
6052	4
6053	5
6054	6
6055	7
6056	8
6057	9
6058	Enter
6059	Num Lock

Table 7-7 *USB Extended Keypad Character Set*

Extended Keypad	Keystroke
7001	Break
7002	Delete
7003	PgUp
7004	End
7005	Pg Dn

Table 7-7 *USB Extended Keypad Character Set (Continued)*

Extended Keypad	Keystroke
7006	Pause
7007	Scroll Lock
7008	Backspace
7009	Tab
7010	Print Screen
7011	Insert
7012	Home
7013	Enter
7014	Escape
7015	Up Arrow
7016	Down Arrow
7017	Left Arrow
7018	Right Arrow

Chapter 8 RS-232 Interface

Introduction

This chapter describes how to set up the digital imager scanner with an RS-232 host. Use the RS-232 interface to connect the digital imager scanner to point-of-sale devices, host computers, or other devices with an available RS-232 port (e.g., com port).

If your host does not appear in [Table 8-2](#), refer to the documentation for the host device to set communication parameters to match the host.

- ✓ **NOTE** The digital imager scanner uses TTL RS-232 signal levels, which interface with most system architectures. For system architectures requiring RS-232C signal levels, Motorola offers different cables providing TTL-to-RS-232C conversion. Contact Motorola Enterprise Mobility Support for more information.

Throughout the programming bar code menus, asterisks (*) indicate default values.



* Indicates Default — *Baud Rate 57,600 — Feature/Option

- ✓ **NOTE** Most computer monitors allow scanning the bar codes directly on the screen. When scanning from the screen, be sure to set the document magnification to a level where you can see the bar code clearly, and bars and/or spaces are not merging.

Connecting an RS-232 Interface

The digital imager scanner connects directly to the host computer.

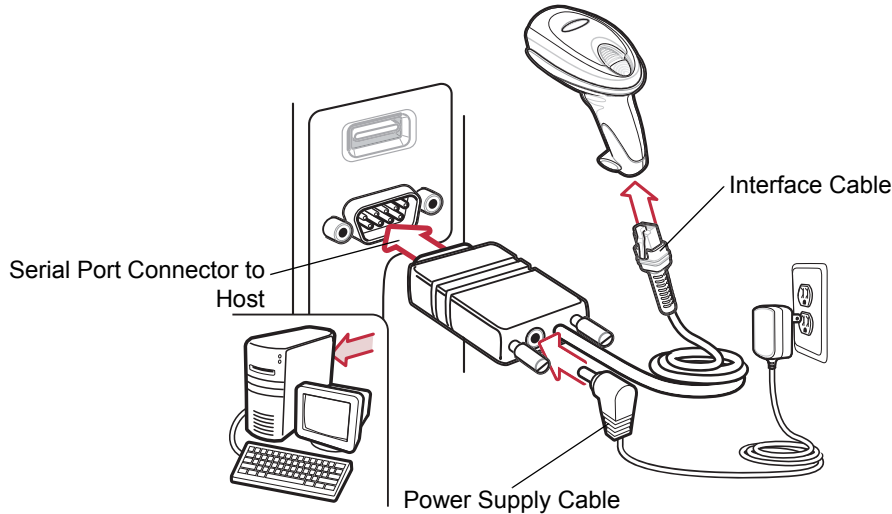

Figure 8-1 RS-232 Direct Connection

✓ **NOTE** Interface cables vary depending on configuration. The connectors illustrated in [Figure 8-1](#) are examples only. The connectors may be different than those illustrated, but the steps to connect the scanner are the same.

1. Connect the modular connector of the RS-232 interface cable to the cable interface port on the digital imager scanner (see [Installing the Interface Cable on page 1-3](#)).
2. Connect the other end of the RS-232 interface cable to the serial port on the host.
3. Connect the power supply to the serial connector end of the RS-232 interface cable. Plug the power supply into an appropriate outlet.
4. Select the RS-232 host type by scanning the appropriate bar code from [RS-232 Host Types on page 8-6](#).
5. To modify any other parameter options, scan the appropriate bar codes in this chapter.

RS-232 Parameter Defaults

[Table 8-1](#) lists the defaults for RS-232 host parameters. To change any option, scan the appropriate bar code(s) provided in the RS-232 Host Parameters section beginning on [page 8-4](#).

✓ **NOTE** See [Appendix A, Standard Default Parameters](#) for all user preferences, hosts, symbologies, and miscellaneous default parameters.

Table 8-1 RS-232 Host Default Table

Parameter	Default	Page Number
RS-232 Host Parameters		
RS-232 Host Types	Standard	8-6
Baud Rate	9600	8-7
Parity Type	None	8-9
Stop Bit Select	1 Stop Bit	8-10
Data Bits	8-Bit	8-10
Check Receive Errors	Enable	8-11
Hardware Handshaking	None	8-11
Software Handshaking	None	8-13
Host Serial Response Time-out	2 Sec	8-15
RTS Line State	Low RTS	8-16
Beep on <BEL>	Disable	8-16
Intercharacter Delay	0 msec	8-17
Nixdorf Beep/LED Options	Normal Operation	8-18
Ignore Unknown Characters	Send Bar Code	8-18

RS-232 Host Parameters

Various RS-232 hosts use their own parameter default settings. Selecting standard, ICL, Fujitsu, Wincor-Nixdorf Mode A, Wincor-Nixdorf Mode B, OPOS/JPOS, Olivetti, or Omron sets the defaults listed in [Table 8-2](#).

Table 8-2 Terminal Specific RS-232

Parameter	ICL	Fujitsu	Wincor-Nixdorf Mode A	Wincor-Nixdorf Mode B/ OPOS/JPOS	Olivetti	Omron
Transmit Code ID	Yes	Yes	Yes	Yes	Yes	Yes
Data Transmission Format	Data/Suffix	Data/Suffix	Data/Suffix	Data/Suffix	Prefix/Data/Suffix	Data/Suffix
Suffix	CR (1013)	CR (1013)	CR (1013)	CR (1013)	ETX (1002)	CR (1013)
Baud Rate	9600	9600	9600	9600	9600	9600
Parity	Even	None	Odd	Odd	Even	None
Hardware Handshaking	RTS/CTS Option 3	None	RTS/CTS Option 3	RTS/CTS Option 3	None	None
Software Handshaking	None	None	None	None	Ack/Nak	None
Serial Response Time-out	9.9 Sec.	2 Sec.	9.9 Sec.	9.9 Sec.	9.9 Sec.	9.9 Sec.
Stop Bit Select	One	One	One	One	One	One
ASCII Format	8-Bit	8-Bit	8-Bit	8-Bit	7-Bit	8-Bit
Beep On <BEL>	Disable	Disable	Disable	Disable	Disable	Disable
RTS Line State	High	Low	Low	Low = No data to send	Low	High
Prefix	None	None	None	None	STX (1003)	None

***In the Nixdorf Mode B, if CTS is low, scanning is disabled. When CTS is high, scanning is enabled.**

****If you select Nixdorf Mode B without connecting the digital imager scanner to the proper host, it may appear unable to scan. If this happens, scan a different RS-232 host type within 5 seconds of cycling power to the digital imager scanner.**

RS-232 Host Types

To select an RS-232 host interface, scan one of the following bar codes.

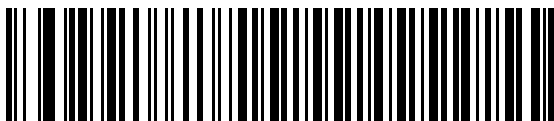

Standard RS-232¹



ICL RS-232

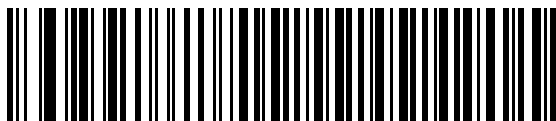

Wincor-Nixdorf RS-232 Mode A

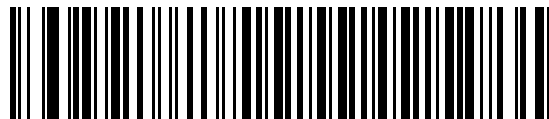

Wincor-Nixdorf RS-232 Mode B



Olivetti ORS4500



Omron

¹Scanning Enable RS-232 (No Variant) activates the RS-232 driver, but does not change port settings (e.g., parity, data bits, handshaking). Selecting another RS-232 host type bar code changes these settings.

RS-232 Host Types (continued)

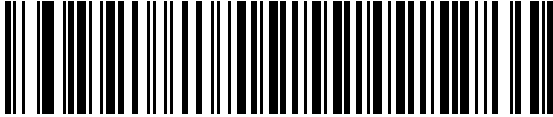

OPOS/JPOS

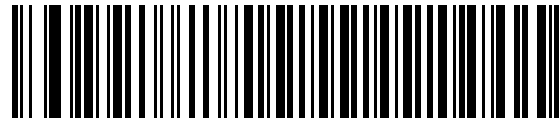

Fujitsu RS-232

Baud Rate

Baud rate is the number of bits of data transmitted per second. Set the digital imager scanner's baud rate to match the baud rate setting of the host device. Otherwise, data may not reach the host device or may reach it in distorted form.



Baud Rate 600



Baud Rate 1200



Baud Rate 2400



Baud Rate 4800

Baud Rate (continued)



*Baud Rate 9600



Baud Rate 19,200



Baud Rate 38,400



Baud Rate 57,600



Baud Rate 115,200

Parity

A parity check bit is the most significant bit of each ASCII coded character. Select the parity type according to host device requirements.

- Select **Odd** parity to set the parity bit value to 0 or 1, based on data, to ensure that the coded character contains an odd number of 1 bits
- Select **Even** parity to set the parity bit value to 0 or 1, based on data, to ensure that the coded character contains an even number of 1 bits.
- Select **None** when no parity bit is required.

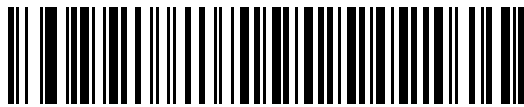

Odd

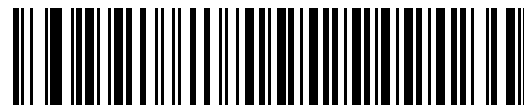

Even

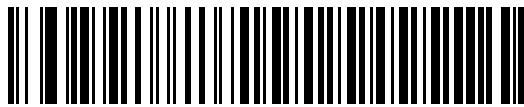

*None

Stop Bit Select

The stop bit(s) at the end of each transmitted character marks the end of transmission of one character and prepares the receiving device for the next character in the serial data stream. Select the number of stop bits (one or two) based on the number the receiving terminal is programmed to accommodate. Set the number of stop bits to match host device requirements.



Data Bits

This parameter allows the digital imager scanner to interface with devices requiring a 7-bit or 8-bit ASCII protocol.



Check Receive Errors

Select whether or not to check the parity, framing, and overrun of received characters. The parity value of received characters is verified against the parity parameter selected above.

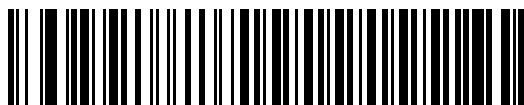

*Check For Received Errors

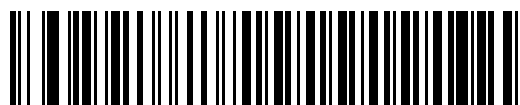

Do Not Check For Received Errors

Hardware Handshaking

The data interface consists of an RS-232 port designed to operate either with or without the hardware handshaking lines, *Request to Send* (RTS), and *Clear to Send* (CTS).

Disable Standard RTS/CTS handshaking to transmit scan data as it becomes available. Select Standard RTS/CTS handshaking to transmit scan data according to the following sequence:

- The digital imager scanner reads the CTS line for activity. If CTS is asserted, the digital imager scanner waits up to Host Serial Response Time-out for the host to de-assert the CTS line. If, after Host Serial Response Time-out (default), the CTS line is still asserted, the digital imager scanner sounds a transmit error, and discards any scanned data.
- When the CTS line is de-asserted, the digital imager scanner asserts the RTS line and waits up to Host Serial Response Time-out for the host to assert CTS. When the host asserts CTS, the scanner transmits data. If, after Host Serial Response Time-out (default), the CTS line is not asserted, the digital imager scanner sounds a transmit error, and discards the data.
- When data transmission completes, the digital imager scanner de-asserts RTS 10 msec after sending the last character.
- The host should respond by negating CTS. The digital imager scanner checks for a de-asserted CTS upon the next transmission of data.

During data transmission, the CTS line should be asserted. If CTS is deasserted for more than 50 ms between characters, the scanner aborts transmission, sounds a transmission error, and discards the data.

If this communication sequence fails, the digital imager scanner issues an error indication. In this case, the data is lost and must be rescanned.

If hardware handshaking and software handshaking are both enabled, hardware handshaking takes precedence.

✓ **NOTE** The DTR signal is jumpered to the active state.

Hardware Handshaking (continued)

- **None:** Scan this bar code to disable hardware handshaking.
- **Standard RTS/CTS:** Scan this bar code to select Standard RTS/CTS Hardware Handshaking.
- **RTS/CTS Option 1:** If you select RTS/CTS Option 1, the digital imager scanner asserts RTS before transmitting and ignores the state of CTS. The digital imager scanner de-asserts RTS when the transmission is complete.
- **RTS/CTS Option 2:** If you select Option 2, RTS is always high or low (user-programmed logic level). However, the digital imager scanner waits for CTS to be asserted before transmitting data. If CTS is not asserted within Host Serial Response Time-out (default), the digital imager scanner issues an error indication and discards the data.
- **RTS/CTS Option 3:** If you select Option 3, the digital imager scanner asserts RTS prior to any data transmission, regardless of the state of CTS. The digital imager scanner waits up to Host Serial Response Time-out (default) for CTS to be asserted. If CTS is not asserted during this time, the digital imager scanner issues an error indication and discards the data. The digital imager scanner de-asserts RTS when transmission completes.

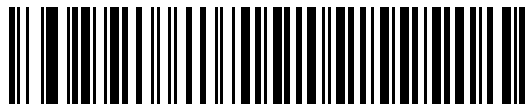

*None



Standard RTS/CTS



RTS/CTS Option 1

Hardware Handshaking (continued)

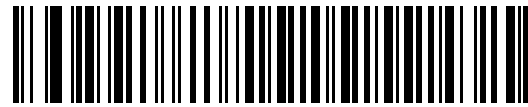

RTS/CTS Option 2

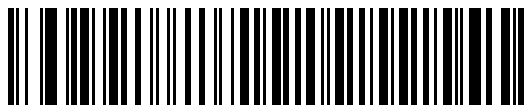

RTS/CTS Option 3

Software Handshaking

This parameter offers control of the data transmission process in addition to, or instead of, that offered by hardware handshaking. There are five options.

If software handshaking and hardware handshaking are both enabled, hardware handshaking takes precedence.

- **None:** Select this option to transmit data immediately. No response is expected from host.
- **ACK/NAK:** If you select this option, after transmitting data, the digital imager scanner expects either an ACK or NAK response from the host. When it receives a NAK, the digital imager scanner transmits the same data again and waits for either an ACK or NAK. After three unsuccessful attempts to send data after receiving NAKs, the digital imager scanner issues an error indication and discards the data.

The digital imager scanner waits up to the programmable Host Serial Response Time-out to receive an ACK or NAK. If the digital imager scanner does not get a response in this time, it issues an error indication and discards the data. There are no retries when a time-out occurs.

- **ENQ:** If you select this option, the digital imager scanner waits for an ENQ character from the host before transmitting data. If it does not receive an ENQ within the Host Serial Response Time-out, the digital imager scanner issues an error indication and discards the data. The host must transmit an ENQ character at least every Host Serial Response Time-out to prevent transmission errors.
- **ACK/NAK with ENQ:** This combines the two previous options. For re-transmissions of data, due to a NAK from the host, an additional ENQ is not required.

Software Handshaking (continued)

- **XON/XOFF:** An XOFF character turns the digital imager scanner transmission off until the digital imager scanner receives an XON character. There are two situations for XON/XOFF:
 - The scanner receives an XOFF before it has data to send. When the digital imager scanner has data to send, it waits up to Host Serial Response Time-out for an XON character before transmission. If it does not receive the XON within this time, the digital imager scanner issues an error indication and discards the data.
 - The scanner receives an XOFF during a transmission. Data transmission then stops after sending the current byte. When the digital imager scanner receives an XON character, it sends the rest of the data message. The digital imager scanner waits indefinitely for the XON.



*None



ACK/NAK



ENQ

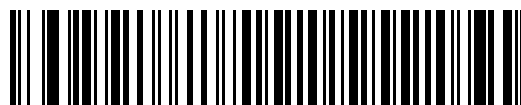

ACK/NAK with ENQ



XON/XOFF

Host Serial Response Time-out

This parameter specifies how long the digital imager scanner waits for an ACK, NAK, or CTS before determining that a transmission error occurred. This only applies when in one of the ACK/NAK software handshaking modes, or RTS/CTS hardware handshaking mode.



***Minimum: 2 Sec**



Low: 2.5 Sec

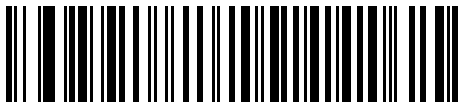

Medium: 5 Sec



High: 7.5 Sec

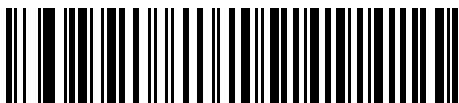

Maximum: 9.9 Sec

RTS Line State

This parameter sets the idle state of the Serial Host RTS line. Scan a bar code below to select **Low RTS** or **High RTS** line state.



*Host: Low RTS



Host: High RTS

Beep on <BEL>

If you enable this parameter, the digital imager scanner issues a beep when it detects a <BEL> character on the RS-232 serial line. <BEL> gains a user's attention to an illegal entry or other important event.



Beep On <BEL> Character
(Enable)



*Do Not Beep On <BEL> Character
(Disable)

Intercharacter Delay

This parameter specifies the intercharacter delay inserted between character transmissions.



***Minimum: 0 msec**



Low: 25 msec

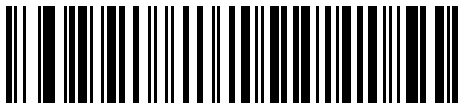

Medium: 50 msec



High: 75 msec

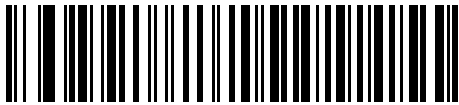

Maximum: 99 msec

Nixdorf Beep/LED Options

If you selected Nixdorf Mode B, this indicates when the digital imager scanner beeps and turns on its LED after a decode.



***Normal Operation**
(Beep/LED immediately after decode)

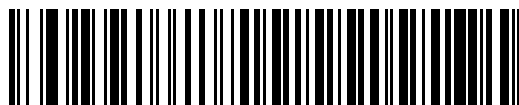

Beep/LED After Transmission

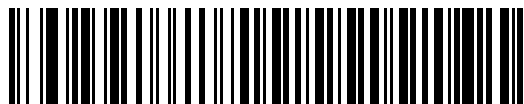

Beep/LED After CTS Pulse

Ignore Unknown Characters

Unknown characters are characters the host does not recognize. Select **Send Bar Codes with Unknown Characters** to send all bar code data except for unknown characters. The scanner sounds no error beeps.

Select **Do Not Send Bar Codes With Unknown Characters** to send bar code data up to the first unknown character. The scanner sounds an error beep.



***Send Bar Code**
(with unknown characters)

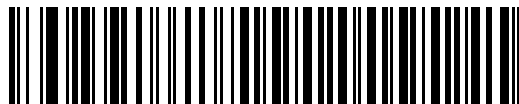

Do Not Send Bar Codes
(with unknown characters)

ASCII Character Set for RS-232

You can assign the values in [Table 8-4](#) as prefixes or suffixes for ASCII character data transmission.

Table 8-4 *Prefix/Suffix Values*

Prefix/Suffix Value	Full ASCII Code 39 Encode Character	ASCII Character
1000	%U	NUL
1001	\$A	SOH
1002	\$B	STX
1003	\$C	ETX
1004	\$D	EOT
1005	\$E	ENQ
1006	\$F	ACK
1007	\$G	BELL
1008	\$H	BCKSPC
1009	\$I	HORIZ TAB
1010	\$J	LF/NW LN
1011	\$K	VT
1012	\$L	FF
1013	\$M	CR/ENTER
1014	\$N	SO
1015	\$O	SI
1016	\$P	DLE
1017	\$Q	DC1/XON
1018	\$R	DC2
1019	\$S	DC3/XOFF
1020	\$T	DC4
1021	\$U	NAK
1022	\$V	SYN
1023	\$W	ETB
1024	\$X	CAN
1025	\$Y	EM
1026	\$Z	SUB

Table 8-4 *Prefix/Suffix Values (Continued)*

Prefix/Suffix Value	Full ASCII Code 39 Encode Character	ASCII Character
1027	%A	ESC
1028	%B	FS
1029	%C	GS
1030	%D	RS
1031	%E	US
1032	Space	Space
1033	/A	!
1034	/B	"
1035	/C	#
1036	/D	\$
1037	/E	%
1038	/F	&
1039	/G	'
1040	/H	(
1041	/I)
1042	/J	*
1043	/K	+
1044	/L	,
1045	-	-
1046	.	.
1047	/O	/
1048	0	0
1049	1	1
1050	2	2
1051	3	3
1052	4	4
1053	5	5
1054	6	6
1055	7	7
1056	8	8

Table 8-4 *Prefix/Suffix Values (Continued)*

Prefix/Suffix Value	Full ASCII Code 39 Encode Character	ASCII Character
1057	9	9
1058	/Z	:
1059	%F	;
1060	%G	<
1061	%H	=
1062	%I	>
1063	%J	?
1064	%V	@
1065	A	A
1066	B	B
1067	C	C
1068	D	D
1069	E	E
1070	F	F
1071	G	G
1072	H	H
1073	I	I
1074	J	J
1075	K	K
1076	L	L
1077	M	M
1078	N	N
1079	O	O
1080	P	P
1081	Q	Q
1082	R	R
1083	S	S
1084	T	T
1085	U	U
1086	V	V

Table 8-4 *Prefix/Suffix Values (Continued)*

Prefix/Suffix Value	Full ASCII Code 39 Encode Character	ASCII Character
1087	W	W
1088	X	X
1089	Y	Y
1090	Z	Z
1091	%K	[
1092	%L	\
1093	%M]
1094	%N	^
1095	%O	_
1096	%W	`
1097	+A	a
1098	+B	b
1099	+C	c
1100	+D	d
1101	+E	e
1102	+F	f
1103	+G	g
1104	+H	h
1105	+I	i
1106	+J	j
1107	+K	k
1108	+L	l
1109	+M	m
1110	+N	n
1111	+O	o
1112	+P	p
1113	+Q	q
1114	+R	r
1115	+S	s
1116	+T	t

Table 8-4 *Prefix/Suffix Values (Continued)*

Prefix/Suffix Value	Full ASCII Code 39 Encode Character	ASCII Character
1117	+U	u
1118	+V	v
1119	+W	w
1120	+X	x
1121	+Y	y
1122	+Z	z
1123	%P	{
1124	%Q	
1125	%R	}
1126	%S	~
1127		Undefined
7013		ENTER

Chapter 9 123Scan

Introduction

123Scan is a Windows[®]-based utility that programs the digital imager scanner with all parameters including Advanced Data Formatting (ADF) rules. An ADF rule modifies bar code data before sending it to the host to ensure compatibility between bar coded data and the host application. Program digital imager scanners via PC download or by scanning a sheet of bar codes generated by the 123Scan utility. Digital imager scanner programming is saved in a file for electronic distribution. The 123Scan program includes a help file.

Communication with 123Scan

To communicate with the 123Scan program which runs on a host computer running a Windows operating system, use an RS-232 cable to connect the digital imager scanner to the host computer (see [Connecting an RS-232 Interface on page 8-2](#)).

123Scan requirements:

- Host computer with Windows 98, Windows NT, Windows 2000, or Windows XP
- Digital imager scanner
- RS-232 cable.

123Scan Parameter

To communicate with the 123Scan program, load 123Scan, included in the documentation CD-ROM, onto the host computer, and scan the bar code below. Refer to 123Scan instructions for programming the digital imager scanner.

Scan the bar code below to enable the 123Scan interface on the digital imager scanner.



123Scan Configuration

Chapter 10 Symbologies

Introduction

This chapter describes symbology features and provides programming bar codes for selecting these features. Before programming, follow the instructions in [Chapter 1, Getting Started](#).

To set feature values, scan a single bar code or a short bar code sequence. The settings are stored in non-volatile memory and are preserved even when you power down the digital imager scanner.

- ✓ **NOTE** Most computer monitors allow scanning the bar codes directly on the screen. When scanning from the screen, be sure to set the document magnification to a level where you can see the bar code clearly, and bars and/or spaces are not merging.

Select a host type (see each host chapter for specific host information) after the power-up beeps sound. This is only necessary upon the first power-up when connecting to a new host.

To return all features to default values, scan the [Set Default Parameter on page 4-4](#). Throughout the programming bar code menus, asterisks (*) indicate default values.

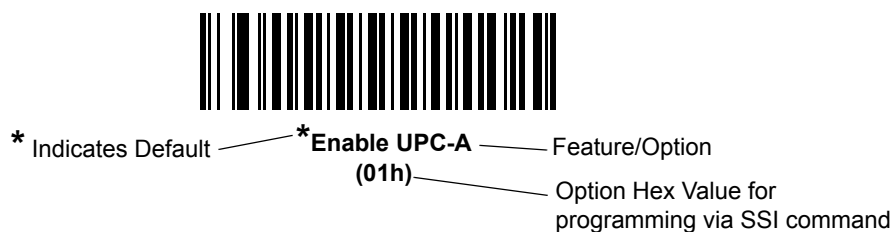

Scanning Sequence Examples

In most cases, scanning one bar code sets the parameter value. For example, to transmit bar code data without the UPC-A check digit, simply scan the **Do Not Transmit UPC-A Check Digit** bar code under [Transmit UPC-A Check Digit on page 10-14](#). The digital imager scanner issues a fast warble beep and the LED turns green, signifying a successful parameter entry.

Other parameters, such as **Set Length(s) for D 2 of 5** require scanning several bar codes. See the individual parameter, such as **Set Length(s) for D 2 of 5**, for this procedure.

Errors While Scanning

Unless otherwise specified, to correct an error during a scanning sequence, just re-scan the correct parameter.

Symbology Parameter Defaults

[Table 10-1](#) lists the defaults for all symbologies parameters. There are two ways to change the default values:

- Scan the appropriate bar codes in this guide. These new values replace the standard default values in memory. To recall the default parameter values, scan the [Set Default Parameter on page 4-4](#).
- Download data through the device's serial port using SSI. Hexadecimal parameter numbers appear in this chapter below the parameter title, and options appear in parenthesis beneath the accompanying bar codes. See the *Simple Serial Interface (SSI) Programmer's Guide* for detailed instructions for changing parameters using this method.

✓ **NOTE** See [Appendix A, Standard Default Parameters](#) for all user preferences, hosts, and miscellaneous default parameters.

Table 10-1 *Parameter Defaults*

Parameter	Parameter Number	Default	Page Number
UPC/EAN			
UPC-A	01h	Enable	10-7
UPC-E	02h	Enable	10-7
UPC-E1	0Ch	Disable	10-8
EAN-8/JAN 8	04h	Enable	10-8
EAN-13/JAN 13	03h	Enable	10-9
Bookland EAN	53h	Disable	10-9
Decode UPC/EAN/JAN Supplementals (2 and 5 digits)	10h	Ignore	10-10
User-Programmable Supplementals			10-13
Supplemental 1:	F1h 43h		
Supplemental 2:	F1h 44h		
UPC/EAN/JAN Supplemental Redundancy	50h	10	10-14
Transmit UPC-A Check Digit	28h	Enable	10-14
Transmit UPC-E Check Digit	29h	Enable	10-14
Transmit UPC-E1 Check Digit	2Ah	Enable	10-15
UPC-A Preamble	22h	System Character	10-16
UPC-E Preamble	23h	System Character	10-16

Table 10-1 *Parameter Defaults (Continued)*

Parameter	Parameter Number	Default	Page Number
UPC-E1 Preamble	24h	System Character	10-18
Convert UPC-E to A	25h	Disable	10-19
Convert UPC-E1 to A	26h	Disable	10-19
EAN-8/JAN-8 Extend	27h	Disable	10-20
Bookland ISBN Format	F1h 40h	ISBN-10	10-21
UCC Coupon Extended Code	55h	Disable	10-22
ISSN EAN	F1h 69h	Disable	10-22
Code 128			
Code 128	08h	Enable	10-23
Set Length(s) for Code 128	D1h D2h	Any Length	10-23
GS1-128 (formerly UCC/EAN-128)	0Eh	Enable	10-25
ISBT 128	54h	Enable	10-25
ISBT Concatenation	F1h 41h	Disable	10-26
Check ISBT Table	F1h 42h	Enable	10-27
ISBT Concatenation Redundancy	DFh	10	10-27
Code 39			
Code 39	00h	Enable	10-28
Trioptic Code 39	0Dh	Disable	10-28
Convert Code 39 to Code 32 (Italian Pharmacy Code)	56h	Disable	10-29
Code 32 Prefix	E7h	Disable	10-29
Set Length(s) for Code 39	12h 13h	2 to 55	10-30
Code 39 Check Digit Verification	30h	Disable	10-31
Transmit Code 39 Check Digit	2Bh	Disable	10-32
Code 39 Full ASCII Conversion	11h	Disable	10-32
Buffer Code 39	71h	Disable	10-33
Code 93			
Code 93	09h	Disable	10-36
Set Length(s) for Code 93	1Ah 1Bh	4 to 55	10-36

Table 10-1 *Parameter Defaults (Continued)*

Parameter	Parameter Number	Default	Page Number
Code 11			
Code 11	0Ah	Disable	10-38
Set Lengths for Code 11	1Ch 1Dh	4 to 55	10-38
Code 11 Check Digit Verification	34h	Disable	10-40
Transmit Code 11 Check Digit(s)	2Fh	Disable	10-41
Interleaved 2 of 5 (ITF)			
Interleaved 2 of 5 (ITF)	06h	Enable	10-42
Set Lengths for I 2 of 5	16h 17h	14	10-42
I 2 of 5 Check Digit Verification	31h	Disable	10-44
Transmit I 2 of 5 Check Digit	2Ch	Disable	10-44
Convert I 2 of 5 to EAN 13	52h	Disable	10-45
Discrete 2 of 5 (DTF)			
Discrete 2 of 5	05h	Disable	10-46
Set Length(s) for D 2 of 5	14h 15h	12	10-46
Codabar (NW - 7)			
Codabar	07h	Disable	10-48
Set Lengths for Codabar	18h 19h	5 to 55	10-48
CLSI Editing	36h	Disable	10-50
NOTIS Editing	37h	Disable	10-50
MSI			
MSI	0Bh	Disable	10-51
Set Length(s) for MSI	1Eh 1Fh	4 to 55	10-51
MSI Check Digits	32h	One	10-52
Transmit MSI Check Digit	2Eh	Disable	10-53
MSI Check Digit Algorithm	33h	Mod 10/Mod 10	10-53
Chinese 2 of 5			
Chinese 2 of 5	F0h 98h	Disable	10-54

Table 10-1 *Parameter Defaults (Continued)*

Parameter	Parameter Number	Default	Page Number
Matrix 2 of 5			
Matrix 2 of 5	F1h 6Ah	Disable	10-55
Matrix 2 of 5 Lengths	F1h 6Bh F1h 6Ch	1 Length - 14	10-56
Matrix 2 of 5 Redundancy	F1h 6Dh	Disable	10-57
Matrix 2 of 5 Check Digit	F1h 6Eh	Disable	10-57
Transmit Matrix 2 of 5 Check Digit	F1h 6Fh	Disable	10-58
Inverse 1D	F1h 4Ah	SR, DC: Regular DP, HD: Autodetect	10-59
Postal Codes			
US Postnet	59h	Enable	10-60
US Planet	5Ah	Enable	10-60
Transmit US Postal Check Digit	5Fh	Enable	10-61
UK Postal	5Bh	Enable	10-61
Transmit UK Postal Check Digit	60h	Enable	10-62
Japan Postal	F0h 22h	Enable	10-62
Australian Postal	F0h 23h	Enable	10-63
Netherlands KIX Code	F0h 46h	Enable	10-63
USPS 4CB/One Code/Intelligent Mail	F1h 50h	Disable	10-64
UPU FICS Postal	F1h 63h	Disable	10-64
GS1 DataBar			
GS1 DataBar-14	F0h 52h	Enable	10-65
GS1 DataBar Limited	F0h 53h	Enable	10-65
GS1 DataBar Expanded	F0h 54h	Enable	10-66
Convert GS1 DataBar to UPC/EAN	F0h 8Dh	Disable	10-66
Composite			
Composite CC-C	F0h 55h	Disable	10-67
Composite CC-A/B	F0h 56h	Disable	10-67
Composite TLC-39	F0h 73h	Disable	10-68
UPC Composite Mode	F0h 58h	Always Linked	10-69

Table 10-1 *Parameter Defaults (Continued)*

Parameter	Parameter Number	Default	Page Number
Composite Beep Mode	F0h 8Eh	Beep As Each Code Type is Decoded	10-70
GS1-128 Emulation Mode for UCC/EAN Composite Codes	F0h ABh	Disable	10-70
2-D Symbologies			
PDF417	0Fh	Enable	10-71
MicroPDF417	E3h	Disable	10-71
Code 128 Emulation	7Bh	Disable	10-72
Data Matrix	F0h 24h	Enable	10-73
Data Matrix Inverse	F1h 4Ch	SR, DC: Regular DP, HD: Autodetect	10-74
Maxicode	F0h 26h	Enable	10-75
QR Code	F0h 25h	Enable	10-75
QR Inverse	F1h 4Bh	SR, DC: Regular DP, HD: Autodetect	10-76
MicroQR	F1h 3Dh	Enable	10-77
Aztec	F1h 3Eh	Enable	10-77
Aztec Inverse	F1h 4Dh	SR, DC: Regular DP, HD: Autodetect	10-78
Symbology-Specific Security Levels			
Redundancy Level	4Eh	1	10-79
Security Level	4Dh	1	10-81
Intercharacter Gap Size	F0h 7Dh	Normal	10-82
Report Version			10-82
Macro PDF			
Flush Macro PDF Buffer			10-83
Abort Macro PDF Entry			10-83

UPC/EAN

Enable/Disable UPC-A

Parameter # 01h

To enable or disable UPC-A, scan the appropriate bar code below.

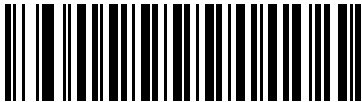

*Enable UPC-A
(01h)

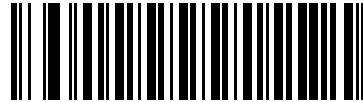

Disable UPC-A
(00h)

Enable/Disable UPC-E

Parameter # 02h

To enable or disable UPC-E, scan the appropriate bar code below.

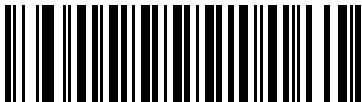

*Enable UPC-E
(01h)

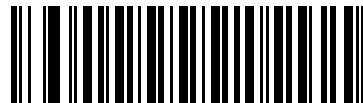

Disable UPC-E
(00h)

Enable/Disable UPC-E1

Parameter # 0Ch

UPC-E1 is disabled by default.

To enable or disable UPC-E1, scan the appropriate bar code below.

✓ **NOTE** UPC-E1 is not a UCC (Uniform Code Council) approved symbology.

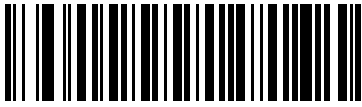

Enable UPC-E1
(01h)

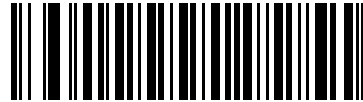

*Disable UPC-E1
(00h)

Enable/Disable EAN-8/JAN-8

Parameter # 04h

To enable or disable EAN-8/JAN-8, scan the appropriate bar code below.

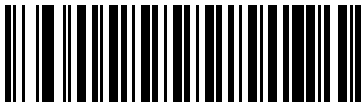

*Enable EAN-8/JAN-8
(01h)



Disable EAN-8/JAN-8
(00h)

Enable/Disable EAN-13/JAN-13

Parameter # 03h

To enable or disable EAN-13/JAN-13, scan the appropriate bar code below.

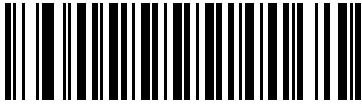

*Enable EAN-13/JAN-13
(01h)

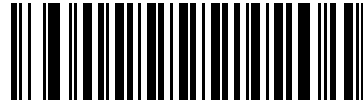

Disable EAN-13/JAN-13
(00h)

Enable/Disable Bookland EAN

Parameter # 53h

To enable or disable Bookland EAN, scan the appropriate bar code below.



Enable Bookland EAN
(01h)



*Disable Bookland EAN
(00h)



NOTE If you enable Bookland EAN, select a [Bookland ISBN Format on page 10-21](#). Also select either Decode UPC/EAN Supplementals, Autodiscriminate UPC/EAN Supplementals, or Enable 978/979 Supplemental Mode in [Decode UPC/EAN/JAN Supplementals on page 10-10](#).

Decode UPC/EAN/JAN Supplementals

Parameter # 10h

Supplementals are bar codes appended according to specific format conventions (e.g., UPC A+2, UPC E+2, EAN 13+2). The following options are available:

- If you select **Ignore UPC/EAN with Supplementals**, and the scanner is presented with a UPC/EAN plus supplemental symbol, the scanner decodes UPC/EAN and ignores the supplemental characters.
- If you select **Decode UPC/EAN with Supplementals**, the scanner only decodes UPC/EAN symbols with supplemental characters, and ignores symbols without supplementals.
- If you select **Autodiscriminate UPC/EAN Supplementals**, the scanner decodes UPC/EAN symbols with supplemental characters immediately. If the symbol does not have a supplemental, the scanner must decode the bar code the number of times set via [UPC/EAN/JAN Supplemental Redundancy on page 10-14](#) before transmitting its data to confirm that there is no supplemental.
- If you select one of the following **Supplemental Mode** options, the scanner immediately transmits EAN-13 bar codes starting with that prefix that have supplemental characters. If the symbol does not have a supplemental, the scanner must decode the bar code the number of times set via [UPC/EAN/JAN Supplemental Redundancy on page 10-14](#) before transmitting its data to confirm that there is no supplemental. The scanner transmits UPC/EAN bar codes that do not have that prefix immediately.
 - **Enable 378/379 Supplemental Mode**
 - **Enable 978/979 Supplemental Mode**

✓ **NOTE** If you select 978/979 Supplemental Mode and are scanning Bookland EAN bar codes, see [Enable/Disable Bookland EAN on page 10-9](#) to enable Bookland EAN, and select a format using [Bookland ISBN Format on page 10-21](#).

- **Enable 977 Supplemental Mode**
- **Enable 414/419/434/439 Supplemental Mode**
- **Enable 491 Supplemental Mode**
- **Enable Smart Supplemental Mode** - applies to EAN-13 bar codes starting with any prefix listed previously.
- **Supplemental User-Programmable Type 1** - applies to EAN-13 bar codes starting with a 3-digit user-defined prefix. Set this 3-digit prefix using [User-Programmable Supplementals on page 10-13](#).
- **Supplemental User-Programmable Type 1 and 2** - applies to EAN-13 bar codes starting with either of two 3-digit user-defined prefixes. Set the 3-digit prefixes using [User-Programmable Supplementals on page 10-13](#).
- **Smart Supplemental Plus User-Programmable 1** - applies to EAN-13 bar codes starting with any prefix listed previously or the user-defined prefix set using [User-Programmable Supplementals on page 10-13](#).
- **Smart Supplemental Plus User-Programmable 1 and 2** - applies to EAN-13 bar codes starting with any prefix listed previously or one of the two user-defined prefixes set using [User-Programmable Supplementals on page 10-13](#).

✓ **NOTE** To minimize the risk of invalid data transmission, select either to decode or ignore supplemental characters.

Decode UPC/EAN/JAN Supplementals (continued)



Decode UPC/EAN/JAN Only With Supplementals
(01h)

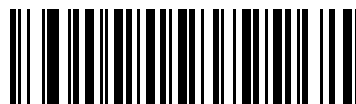

*Ignore Supplementals
(00h)



Autodiscriminate UPC/EAN/JAN Supplementals
(02h)

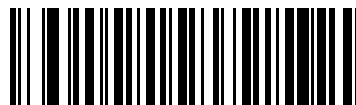

Enable 378/379 Supplemental Mode
(04h)



Enable 978/979 Supplemental Mode
(05h)



Enable 977 Supplemental Mode
(07h)

Decode UPC/EAN/JAN Supplementals (continued)



Enable 414/419/434/439 Supplemental Mode
(06h)



Enable 491 Supplemental Mode
(08h)



Enable Smart Supplemental Mode
(03h)



Supplemental User-Programmable Type 1
(09h)



Supplemental User-Programmable Type 1 and 2
(0Ah)



Smart Supplemental Plus User-Programmable 1
(0Bh)



Smart Supplemental Plus User-Programmable 1 and 2
(0Ch)

User-Programmable Supplementals

Supplemental 1: Parameter # F1h 43h

Supplemental 2: Parameter # F1h 44h

If you selected a Supplemental User-Programmable option from [Decode UPC/EAN/JAN Supplementals on page 10-10](#), select **User-Programmable Supplemental 1** to set the 3-digit prefix. Then select the 3 digits using the numeric bar codes beginning on [page D-1](#). Select **User-Programmable Supplemental 2** to set a second 3-digit prefix. Then select the 3 digits using the numeric bar codes beginning on [page D-1](#).



User-Programmable Supplemental 1



User-Programmable Supplemental 2

UPC/EAN/JAN Supplemental Redundancy

Parameter # 50h

If you selected **Autodiscriminate UPC/EAN/JAN Supplementals**, this option adjusts the number of times a symbol without supplementals is decoded before transmission. The range is from two to thirty times. Five or above is recommended when decoding a mix of UPC/EAN/JAN symbols with and without supplementals. The default is set at 10.

Scan the bar code below to set a decode redundancy value. Next, scan two numeric bar codes in [Appendix D, Numeric Bar Codes](#). Enter a leading zero for single digit numbers. To correct an error or change a selection, scan [Cancel on page D-2](#).

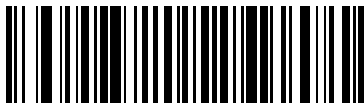

UPC/EAN/JAN Supplemental Redundancy

Transmit UPC-A Check Digit

Parameter # 28h

The check digit is the last character of the symbol used to verify the integrity of the data. Scan the appropriate bar code below to transmit the bar code data with or without the UPC-A check digit. It is always verified to guarantee the integrity of the data.



*Transmit UPC-A Check Digit
(01h)

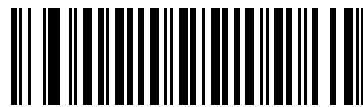

Do Not Transmit UPC-A Check Digit
(00h)

Transmit UPC-E Check Digit

Parameter # 29h

The check digit is the last character of the symbol used to verify the integrity of the data. Scan the appropriate bar code below to transmit the bar code data with or without the UPC-E check digit. It is always verified to guarantee the integrity of the data.

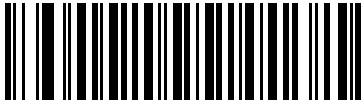

***Transmit UPC-E Check Digit
(01h)**

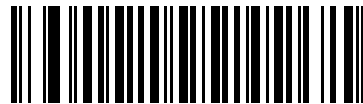

**Do Not Transmit UPC-E Check Digit
(00h)**

Transmit UPC-E1 Check Digit

Parameter # 2Ah

The check digit is the last character of the symbol used to verify the integrity of the data. Scan the appropriate bar code below to transmit the bar code data with or without the UPC-E1 check digit. It is always verified to guarantee the integrity of the data.

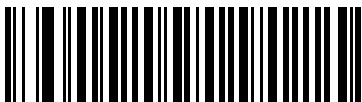

***Transmit UPC-E1 Check Digit
(01h)**



**Do Not Transmit UPC-E1 Check Digit
(00h)**

UPC-A Preamble

Parameter # 22h

Preamble characters are part of the UPC symbol, and include Country Code and System Character. There are three options for transmitting a UPC-A preamble to the host device: transmit System Character only, transmit System Character and Country Code ("0" for USA), and transmit no preamble. Select the appropriate option to match the host system.

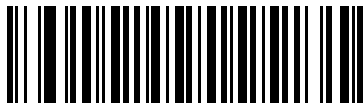

No Preamble (<DATA>)
(00h)



*System Character (<SYSTEM CHARACTER> <DATA>)
(01h)

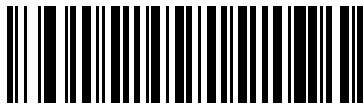

System Character & Country Code
(< COUNTRY CODE> <SYSTEM CHARACTER> <DATA>)
(02h)

UPC-E Preamble

Parameter # 23h

Preamble characters are part of the UPC symbol, and include Country Code and System Character. There are three options for transmitting a UPC-E preamble to the host device: transmit System Character only, transmit System Character and Country Code ("0" for USA), and transmit no preamble. Select the appropriate option to match the host system.

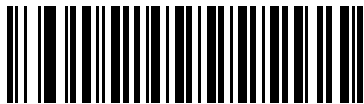

No Preamble (<DATA>)
(00h)

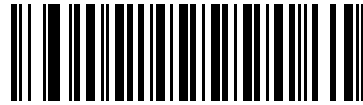

*System Character (<SYSTEM CHARACTER> <DATA>)
(01h)

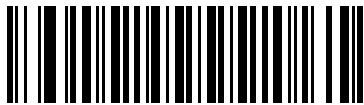

System Character & Country Code
(< COUNTRY CODE> <SYSTEM CHARACTER> <DATA>)
(02h)

UPC-E1 Preamble

Parameter # 24h

Preamble characters are part of the UPC symbol, and include Country Code and System Character. There are three options for transmitting a UPC-E1 preamble to the host device: transmit System Character only, transmit System Character and Country Code ("0" for USA), and transmit no preamble. Select the appropriate option to match the host system.



No Preamble (<DATA>)
(00h)

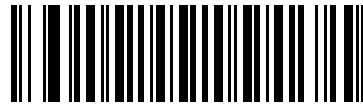

*System Character (<SYSTEM CHARACTER> <DATA>)
(01h)

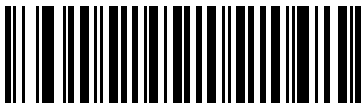

System Character & Country Code
(< COUNTRY CODE> <SYSTEM CHARACTER> <DATA>)
(02h)

Convert UPC-E to UPC-A

Parameter # 25h

Enable this to convert UPC-E (zero suppressed) decoded data to UPC-A format before transmission. After conversion, the data follows UPC-A format and is affected by UPC-A programming selections (e.g., Preamble, Check Digit).

Disable this to transmit UPC-E decoded data as UPC-E data, without conversion.

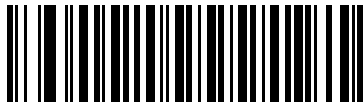

Convert UPC-E to UPC-A (Enable)
(01h)

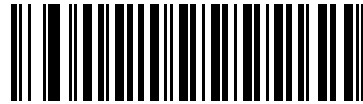

*Do Not Convert UPC-E to UPC-A (Disable)
(00h)

Convert UPC-E1 to UPC-A

Parameter # 26h

Enable this to convert UPC-E1 decoded data to UPC-A format before transmission. After conversion, the data follows UPC-A format and is affected by UPC-A programming selections (e.g., Preamble, Check Digit).

Disable this to transmit UPC-E1 decoded data as UPC-E1 data, without conversion.

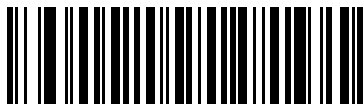

Convert UPC-E1 to UPC-A (Enable)
(01h)

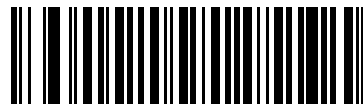

*Do Not Convert UPC-E1 to UPC-A (Disable)
(00h)

EAN-8/JAN-8 Extend

Parameter # 27h

Enable this to add five leading zeros to decoded EAN-8 symbols to make them compatible in format to EAN-13 symbols.

Disable this to transmit EAN-8 symbols as is.

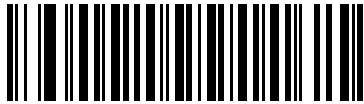

**Enable EAN/JAN Zero Extend
(01h)**

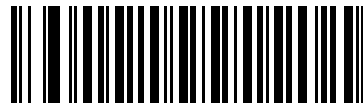

***Disable EAN/JAN Zero Extend
(00h)**

Bookland ISBN Format

Parameter # F1h 40h

If you enabled Bookland EAN using [Enable/Disable Bookland EAN on page 10-9](#), select one of the following formats for Bookland data:

- **Bookland ISBN-10** - The scanner reports Bookland data starting with 978 in traditional 10-digit format with the special Bookland check digit for backward-compatibility. Data starting with 979 is not considered Bookland in this mode.
- **Bookland ISBN-13** - The scanner reports Bookland data (starting with either 978 or 979) as EAN-13 in 13-digit format to meet the 2007 ISBN-13 protocol.



***Bookland ISBN-10**
(00h)



Bookland ISBN-13
(01h)



NOTE For Bookland EAN to function properly, first enable Bookland EAN using [Enable/Disable Bookland EAN on page 10-9](#), then select either Decode UPC/EAN Supplementals, Autodiscriminate UPC/EAN Supplementals, or Enable 978/979 Supplemental Mode in [Decode UPC/EAN/JAN Supplementals on page 10-10](#).

UCC Coupon Extended Code

Parameter # 55h

Enable this to decode UPC-A bar codes starting with digit '5', EAN-13 bar codes starting with digit '99', and UPC-A/GS1-128 Coupon Codes. UPCA, EAN-13, and GS1-128 must be enabled to scan all types of Coupon Codes.

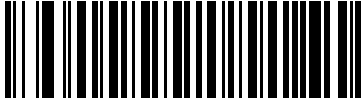

Enable UCC Coupon Extended Code
(01h)

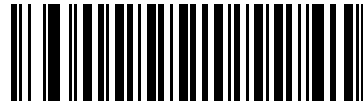

*Disable UCC Coupon Extended Code
(00h)



NOTE Use the *Decode UPC/EAN Supplemental Redundancy* parameter to control autodiscrimination of the GS1-128 (right half) of a coupon code.

ISSN EAN

Parameter # F1h 69h

To enable or disable ISSN EAN, scan the appropriate bar code below.



Enable ISSN EAN
(01h)



*Disable ISSN EAN
(00h)

Code 128

Enable/Disable Code 128

Parameter # 08h

To enable or disable Code 128, scan the appropriate bar code below.



*Enable Code 128
(01h)



Disable Code 128
(00h)

Set Lengths for Code 128

Parameter # L1 = D1h, L2 = D2h

The length of a code refers to the number of characters (i.e., human readable characters), including check digit(s) the code contains. Set lengths for Code 128 to any length, one or two discrete lengths, or lengths within a specific range.

✓ **NOTE** When setting lengths for different bar code types, enter a leading zero for single digit numbers.

- **One Discrete Length** - Select this option to decode only Code 128 symbols containing a selected length. Select the length using the numeric bar codes in [Appendix D, Numeric Bar Codes](#). For example, to decode only Code 128 symbols with 14 characters, scan **Code 128 - One Discrete Length**, then scan **1** followed by **4**. To correct an error or change the selection, scan [Cancel on page D-2](#).
- **Two Discrete Lengths** - Select this option to decode only Code 128 symbols containing either of two selected lengths. Select lengths using the numeric bar codes in [Appendix D, Numeric Bar Codes](#). For example, to decode only Code 128 symbols containing either 2 or 14 characters, select **Code 128 - Two Discrete Lengths**, then scan **0, 2, 1**, and then **4**. To correct an error or change the selection, scan [Cancel on page D-2](#).
- **Length Within Range** - Select this option to decode a Code 128 symbol within a specific length range. Select lengths using numeric bar codes in [Appendix D, Numeric Bar Codes](#). For example, to decode Code 128 symbols containing between 4 and 12 characters, first scan **Code 128 - Length Within Range**. Then scan **0, 4, 1**, and **2** (enter a leading zero for single digit numbers). To correct an error or change the selection, scan [Cancel on page D-2](#).
- **Any Length** - Select this option to decode Code 128 symbols containing any number of characters within the digital scanner's capability.

Set Lengths for Code 128 (continued)

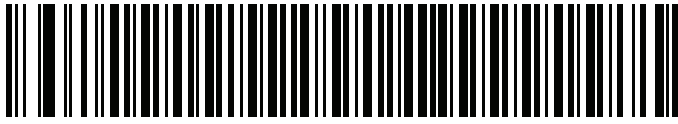

Code 128 - One Discrete Length

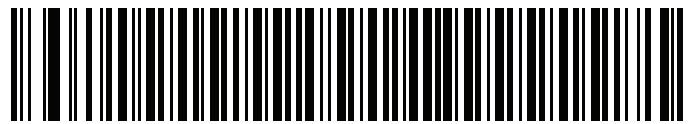

Code 128 - Two Discrete Lengths

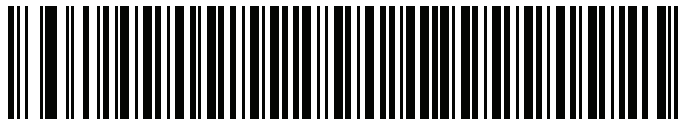

Code 128 - Length Within Range

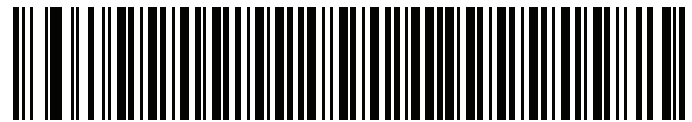

*Code 128 - Any Length

Enable/Disable GS1-128 (formerly UCC/EAN-128)

Parameter # 0Eh

To enable or disable GS1-128, scan the appropriate bar code below.

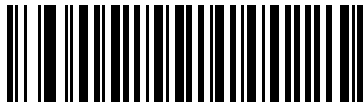

***Enable GS1-128
(01h)**

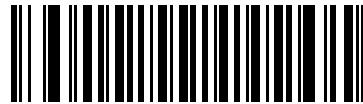

**Disable GS1-128
(00h)**

Enable/Disable ISBT 128

Parameter # 54h

ISBT 128 is a variant of Code 128 used in the blood bank industry. Scan a bar code below to enable or disable ISBT 128. If necessary, the host must perform concatenation of the ISBT data.



***Enable ISBT 128
(01h)**



**Disable ISBT 128
(00h)**

ISBT Concatenation

Parameter # F1h 41h

Select an option for concatenating pairs of ISBT code types:

- If you select **Disable ISBT Concatenation**, the digital scanner does not concatenate pairs of ISBT codes it encounters.
- If you select **Enable ISBT Concatenation**, there must be two ISBT codes in order for the digital scanner to decode and perform concatenation. The digital scanner does not decode single ISBT symbols.
- If you select **Autodiscriminate ISBT Concatenation**, the digital scanner decodes and concatenates pairs of ISBT codes immediately. If only a single ISBT symbol is present, the digital scanner must decode the symbol the number of times set via [ISBT Concatenation Redundancy on page 10-27](#) before transmitting its data to confirm that there is no additional ISBT symbol.



*Disable ISBT Concatenation
(00h)



Enable ISBT Concatenation
(01h)



Autodiscriminate ISBT Concatenation
(02h)

Check ISBT Table

Parameter # F1h 42h

The ISBT specification includes a table that lists several types of ISBT bar codes that are commonly used in pairs. If you set **ISBT Concatenation** to **Enable**, enable **Check ISBT Table** to concatenate only those pairs found in this table. Other types of ISBT codes are not concatenated.



*Enable Check ISBT Table
(01h)



Disable Check ISBT Table
(00h)

ISBT Concatenation Redundancy

Parameter # DFh

If you set **ISBT Concatenation** to **Autodiscriminate**, use this parameter to set the number of times the digital scanner must decode an ISBT symbol before determining that there is no additional symbol.

Scan the bar code below, then scan two numeric bar codes in [Appendix D, Numeric Bar Codes](#) to set a value between 2 and 20. Enter a leading zero for single digit numbers. To correct an error or change a selection, scan [Cancel on page D-2](#). The default is 10.



ISBT Concatenation Redundancy

Code 39

Enable/Disable Code 39

Parameter # 00h

To enable or disable Code 39, scan the appropriate bar code below.

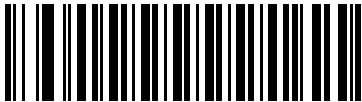

***Enable Code 39
(01h)**

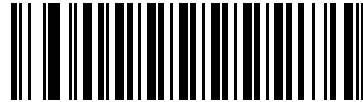

**Disable Code 39
(00h)**

Enable/Disable Trioptic Code 39

Parameter # 0Dh

Trioptic Code 39 is a variant of Code 39 used in the marking of computer tape cartridges. Trioptic Code 39 symbols always contain six characters. To enable or disable Trioptic Code 39, scan the appropriate bar code below.



**Enable Trioptic Code 39
(01h)**



***Disable Trioptic Code 39
(00h)**



NOTE You cannot enable Trioptic Code 39 and Code 39 Full ASCII simultaneously.

Convert Code 39 to Code 32

Parameter # 56h

Code 32 is a variant of Code 39 used by the Italian pharmaceutical industry. Scan the appropriate bar code below to enable or disable converting Code 39 to Code 32.

✓ **NOTE** Code 39 must be enabled for this parameter to function.

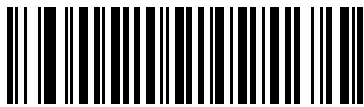

Enable Convert Code 39 to Code 32
(01h)

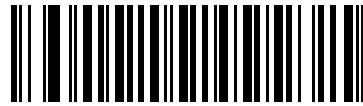

*Disable Convert Code 39 to Code 32
(00h)

Code 32 Prefix

Parameter # E7h

Scan the appropriate bar code below to enable or disable adding the prefix character “A” to all Code 32 bar codes.

✓ **NOTE** Convert Code 39 to Code 32 must be enabled for this parameter to function.

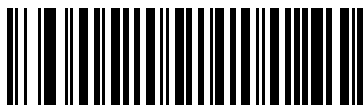

Enable Code 32 Prefix
(01h)



*Disable Code 32 Prefix
(00h)

Set Lengths for Code 39

Parameter # L1 = 12h, L2 = 13h

The length of a code refers to the number of characters (i.e., human readable characters), including check digit(s) the code contains. Set lengths for Code 39 to any length, one or two discrete lengths, or lengths within a specific range. If Code 39 Full ASCII is enabled, **Length Within a Range** or **Any Length** are the preferred options.

✓ **NOTE** When setting lengths for different bar code types, enter a leading zero for single digit numbers.

- **One Discrete Length** - Select this option to decode only Code 39 symbols containing a selected length. Select the length using the numeric bar codes in [Appendix D, Numeric Bar Codes](#). For example, to decode only Code 39 symbols with 14 characters, scan **Code 39 - One Discrete Length**, then scan **1** followed by **4**. To correct an error or change the selection, scan [Cancel on page D-2](#).
- **Two Discrete Lengths** - Select this option to decode only Code 39 symbols containing either of two selected lengths. Select lengths using the numeric bar codes in [Appendix D, Numeric Bar Codes](#). For example, to decode only those Code 39 symbols containing either 2 or 14 characters, select **Code 39 - Two Discrete Lengths**, then scan **0, 2, 1**, and then **4**. To correct an error or change the selection, scan [Cancel on page D-2](#).
- **Length Within Range** - Select this option to decode a Code 39 symbol with a specific length range. Select lengths using numeric bar codes in [Appendix D, Numeric Bar Codes](#). For example, to decode Code 39 symbols containing between 4 and 12 characters, first scan **Code 39 - Length Within Range**. Then scan **0, 4, 1**, and **2** (enter a leading zero for single digit numbers). To correct an error or change the selection, scan [Cancel on page D-2](#).
- **Any Length** - Select this option to decode Code 39 symbols containing any number of characters within the digital imager scanner capability.



Code 39 - One Discrete Length



Code 39 - Two Discrete Lengths

Set Lengths for Code 39 (continued)



Code 39 - Length Within Range



Code 39 - Any Length

Code 39 Check Digit Verification

Parameter # 30h

Enable this feature to check the integrity of all Code 39 symbols to verify that the data complies with specified check digit algorithm. Only Code 39 symbols which include a modulo 43 check digit are decoded, so only enable this if the Code 39 symbols contain a Modulo 43 check digit.

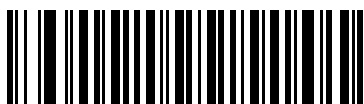

Enable Code 39 Check Digit
(01h)

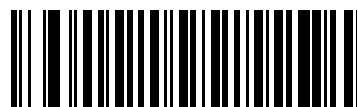

*Disable Code 39 Check Digit
(00h)

Transmit Code 39 Check Digit

Parameter # 2Bh

Scan a bar code below to transmit Code 39 data with or without the check digit.

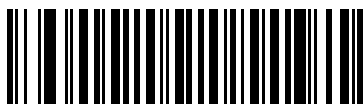

Transmit Code 39 Check Digit (Enable)
(01h)



*Do Not Transmit Code 39 Check Digit (Disable)
(00h)



NOTE Code 39 Check Digit Verification must be enabled for this parameter to function.

Code 39 Full ASCII Conversion

Parameter # 11h

Code 39 Full ASCII is a variant of Code 39 which pairs characters to encode the full ASCII character set. To enable or disable Code 39 Full ASCII, scan the appropriate bar code below.

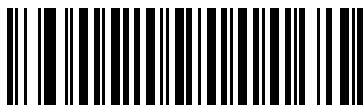

Enable Code 39 Full ASCII
(01h)

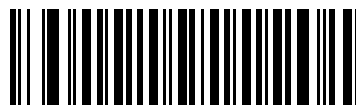

*Disable Code 39 Full ASCII
(00h)



NOTE You cannot enable Trioptic Code 39 and Code 39 Full ASCII simultaneously.

Code 39 Full ASCII to Full ASCII Correlation is host-dependent. See the [ASCII Character Set for USB on page 7-13](#) or the [ASCII Character Set for RS-232 on page 8-19](#) for more information.

Code 39 Buffering (Scan & Store)

Parameter # 71h

This feature allows the digital imager scanner to accumulate data from multiple Code 39 symbols.

Selecting the Scan and Store option (**Buffer Code 39**) temporarily buffers all Code 39 symbols having a leading space as a first character for later transmission. The leading space is not buffered.

Decode of a valid Code 39 symbol with no leading space transmits in sequence all buffered data in a first-in first-out format, plus the “triggering” symbol. See the following pages for further details.

Select **Do Not Buffer Code 39** to transmit all decoded Code 39 symbols immediately without being stored in the buffer.

This feature affects Code 39 only. If selecting **Buffer Code 39**, Motorola recommends configuring the digital imager scanner to decode Code 39 symbology only.

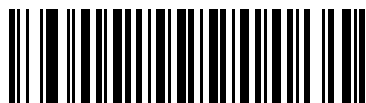

Buffer Code 39 (Enable)
(01h)

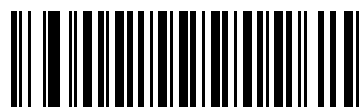

*Do Not Buffer Code 39 (Disable)
(00h)

While there is data in the transmission buffer, you cannot select **Do Not Buffer Code 39**. The buffer holds 200 bytes of information.

To disable Code 39 buffering when there is data in the transmission buffer, first force the buffer transmission (see [Transmit Buffer on page 10-34](#)) or clear the buffer.

Buffer Data

To buffer data, Code 39 buffering must be enabled and a Code 39 symbol must be read with a space immediately following the start pattern.

- Unless the data overflows the transmission buffer, the digital imager scanner issues a low/high beep to indicate successful decode and buffering. For overflow conditions, see [Overfilling Transmission Buffer](#).
- The digital imager scanner adds the decoded data excluding the leading space to the transmission buffer.
- No transmission occurs.

Clear Transmission Buffer

To clear the transmission buffer, scan the **Clear Buffer** bar code below, which contains only a start character, a dash (minus), and a stop character.

- The digital imager scanner issues a short high/low/high beep.
- The digital imager scanner erases the transmission buffer.
- No transmission occurs.



Clear Buffer

- ✓ **NOTE** The Clear Buffer contains only the dash (minus) character. To scan this command, set Code 39 lengths to include length 1.

Transmit Buffer

There are two methods to transmit the Code 39 buffer.

1. Scan the **Transmit Buffer** bar code, which includes only a start character, a plus (+), and a stop character.
2. The digital imager scanner transmits and clears the buffer.
 - The digital imager scanner issues a Low/High beep.



Transmit Buffer

3. Scan a Code 39 bar code with a leading character other than a space.
 - The digital imager scanner appends new decode data to buffered data.
 - The digital imager scanner transmits and clears the buffer.
 - The digital imager scanner signals that the buffer transmitted with a low/high beep.
 - The digital imager scanner transmits and clears the buffer.

- ✓ **NOTE** The Transmit Buffer contains only a plus (+) character. In order to scan this command, set Code 39 lengths to include length 1.

Overfilling Transmission Buffer

The Code 39 buffer holds 200 characters. If the symbol just read results in an overflow of the transmission buffer:

- The digital imager scanner indicates that it rejected the symbol by issuing three long, high beeps.
- No transmission occurs. The data in the buffer is not affected.

Attempt to Transmit an Empty Buffer

If the symbol just read was the **Transmit Buffer** symbol and the Code 39 buffer is empty:

- A short low/high/low beep signals that the buffer is empty.
- No transmission occurs.
- The buffer remains empty.

Code 93

Enable/Disable Code 93

Parameter # 09h

To enable or disable Code 93, scan the appropriate bar code below.

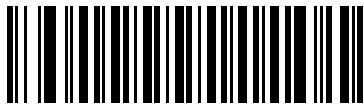

Enable Code 93
(01h)



*Disable Code 93
(00h)

Set Lengths for Code 93

Parameter # L1 = 1Ah, L2 = 1Bh

The length of a code refers to the number of characters (i.e., human readable characters), including check digit(s) the code contains. Set lengths for Code 93 to any length, one or two discrete lengths, or lengths within a specific range.

- **One Discrete Length** - Select this option to decode only Code 93 symbols containing a selected length. Select the length using the numeric bar codes in [Appendix D, Numeric Bar Codes](#). For example, to decode only Code 93 symbols with 14 characters, scan **Code 93 - One Discrete Length**, then scan **1** followed by **4**. To correct an error or to change the selection, scan [Cancel on page D-2](#).
- **Two Discrete Lengths** - Select this option to decode only Code 93 symbols containing either of two selected lengths. Select lengths using the numeric bar codes in [Appendix D, Numeric Bar Codes](#). For example, to decode only Code 93 symbols containing either 2 or 14 characters, select **Code 93 - Two Discrete Lengths**, then scan **0, 2, 1**, and then **4**. To correct an error or to change the selection, scan [Cancel on page D-2](#).
- **Length Within Range** - Select this option to decode a Code 93 symbol with a specific length range. Select lengths using the numeric bar codes in [Appendix D, Numeric Bar Codes](#). For example, to decode Code 93 symbols containing between 4 and 12 characters, first scan **Code 93 - Length Within Range**. Then scan **0, 4, 1**, and **2** (enter a leading zero for single digit numbers). To correct an error or change the selection, scan [Cancel on page D-2](#).
- **Any Length** - Scan this option to decode Code 93 symbols containing any number of characters within the digital imager scanner's capability.

Set Lengths for Code 93 (continued)



Code 93 - One Discrete Length



Code 93 - Two Discrete Lengths



Code 93 - Length Within Range



Code 93 - Any Length

Code 11

Code 11

Parameter # 0Ah

To enable or disable Code 11, scan the appropriate bar code below.

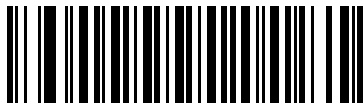

Enable Code 11
(01h)



*Disable Code 11
(00h)

Set Lengths for Code 11

Parameter # L1 = 1Ch, L2 = 1Dh

The length of a code refers to the number of characters (i.e., human readable characters), including check digit(s) the code contains. Set lengths for Code 11 to any length, one or two discrete lengths, or lengths within a specific range.

- **One Discrete Length** - Select this option to decode only Code 11 symbols containing a selected length. Select the length using the numeric bar codes in [Appendix D, Numeric Bar Codes](#). For example, to decode only Code 11 symbols with 14 characters, scan **Code 11 - One Discrete Length**, then scan **1** followed by **4**. To correct an error or to change the selection, scan [Cancel on page D-2](#).
- **Two Discrete Lengths** - Select this option to decode only Code 11 symbols containing either of two selected lengths. Select lengths using the numeric bar codes in [Appendix D, Numeric Bar Codes](#). For example, to decode only those Code 11 symbols containing either 2 or 14 characters, select **Code 11 - Two Discrete Lengths**, then scan **0, 2, 1**, and then **4**. To correct an error or to change the selection, scan [Cancel on page D-2](#).
- **Length Within Range** - Select this option to decode a Code 11 symbol with a specific length range. Select lengths using numeric bar codes in [Appendix D, Numeric Bar Codes](#). For example, to decode Code 11 symbols containing between 4 and 12 characters, first scan **Code 11 - Length Within Range**. Then scan **0, 4, 1**, and **2** (enter a leading zero for single digit numbers). To correct an error or change the selection, scan [Cancel on page D-2](#).
- **Any Length** - Scan this option to decode Code 11 symbols containing any number of characters within the digital imager scanner capability.

Set Lengths for Code 11 (continued)



Code 11 - One Discrete Length



Code 11 - Two Discrete Lengths



Code 11 - Length Within Range



Code 11 - Any Length

Code 11 Check Digit Verification

Parameter # 34h

Enable this to check the integrity of all Code 11 symbols to verify that the data complies with the specified check digit algorithm. This selects the check digit mechanism for the decoded Code 11 bar code. The options are to check for one check digit, check for two check digits, or disable the feature.

To enable this feature, scan the bar code below corresponding to the number of check digits encoded in the Code 11 symbols.

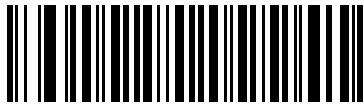

***Disable
(00h)**

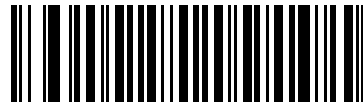

**One Check Digit
(01h)**

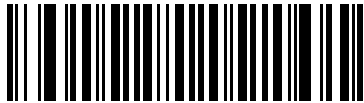

**Two Check Digits
(02h)**

Transmit Code 11 Check Digits

Parameter # 2Fh

This feature selects whether or not to transmit the Code 11 check digit(s).

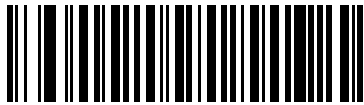

Transmit Code 11 Check Digit(s) (Enable)
(01h)

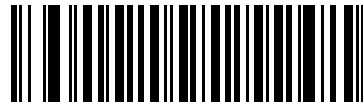

*Do Not Transmit Code 11 Check Digit(s) (Disable)
(00h)



NOTE Code 11 Check Digit Verification must be enabled for this parameter to function.

Interleaved 2 of 5 (ITF)

Enable/Disable Interleaved 2 of 5

Parameter # 06h

To enable or disable Interleaved 2 of 5, scan the appropriate bar code below, and select an Interleaved 2 of 5 length from the following pages.

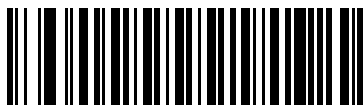

*Enable Interleaved 2 of 5
(01h)



Disable Interleaved 2 of 5
(00h)

Set Lengths for Interleaved 2 of 5

Parameter # L1 = 16h, L2 = 17h

The length of a code refers to the number of characters (i.e., human readable characters), including check digit(s) the code contains. Set lengths for I 2 of 5 to any length, one or two discrete lengths, or lengths within a specific range.

- **One Discrete Length** - Select this option to decode only I 2 of 5 symbols containing a selected length. Select the length using the numeric bar codes in [Appendix D, Numeric Bar Codes](#). For example, to decode only I 2 of 5 symbols with 14 characters, scan **I 2 of 5 - One Discrete Length**, then scan **1** followed by **4**. To correct an error or to change the selection, scan [Cancel on page D-2](#).
- **Two Discrete Lengths** - Select this option to decode only I 2 of 5 symbols containing either of two selected lengths. Select lengths using the numeric bar codes in [Appendix D, Numeric Bar Codes](#). For example, to decode only those I 2 of 5 symbols containing either 2 or 14 characters, select **I 2 of 5 - Two Discrete Lengths**, then scan **0**, **2**, **1**, and then **4**. To correct an error or to change the selection, scan [Cancel on page D-2](#).
- **Length Within Range** - Select this option to decode an I 2 of 5 symbol with a specific length range. Select lengths using numeric bar codes in [Appendix D, Numeric Bar Codes](#). For example, to decode I 2 of 5 symbols containing between 4 and 12 characters, first scan **I 2 of 5 - Length Within Range**. Then scan **0**, **4**, **1**, and **2** (enter a leading zero for single digit numbers). To correct an error or change the selection, scan [Cancel on page D-2](#).
- **Any Length** - Scan this option to decode I 2 of 5 symbols containing any number of characters within the digital imager scanner's capability.

✓ **NOTE** Due to the construction of the I 2 of 5 symbology, it is possible for a scan line covering only a portion of the code to transmit as a complete scan, yielding less data than is encoded in the bar code. To prevent this, select specific lengths (I 2 of 5 - One Discrete Length, Two Discrete Lengths) for I 2 of 5 applications.

Set Lengths for Interleaved 2 of 5



I 2 of 5 - One Discrete Length



I 2 of 5 - Two Discrete Lengths



I 2 of 5 - Length Within Range



I 2 of 5 - Any Length

I 2 of 5 Check Digit Verification

Parameter # 31h

Enable this to check the integrity of all I 2 of 5 symbols to verify the data complies with either the specified Uniform Symbology Specification (USS), or the Optical Product Code Council (OPCC) check digit algorithm.



***Disable
(00h)**



**USS Check Digit
(01h)**



**OPCC Check Digit
(02h)**

Transmit I 2 of 5 Check Digit

Parameter # 2Ch

Scan the appropriate bar code below to transmit I 2 of 5 data with or without the check digit.

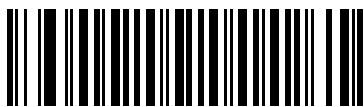

**Transmit I 2 of 5 Check Digit (Enable)
(01h)**



***Do Not Transmit I 2 of 5 Check Digit (Disable)
(00h)**

Convert I 2 of 5 to EAN-13

Parameter # 52h

Enable this parameter to convert 14-character I 2 of 5 codes to EAN-13, and transmit to the host as EAN-13. To accomplish this, the I 2 of 5 code must be enabled, and the code must have a leading zero and a valid EAN-13 check digit.

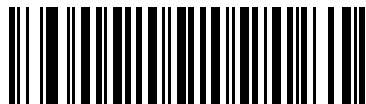

Convert I 2 of 5 to EAN-13 (Enable)
(01h)



*Do Not Convert I 2 of 5 to EAN-13 (Disable)
(00h)

Discrete 2 of 5 (DTF)

Enable/Disable Discrete 2 of 5

Parameter # 05h

To enable or disable Discrete 2 of 5, scan the appropriate bar code below.



Enable Discrete 2 of 5
(01h)



*Disable Discrete 2 of 5
(00h)

Set Lengths for Discrete 2 of 5

Parameter # L1 = 14h, L2 = 15h

The length of a code refers to the number of characters (i.e., human readable characters), including check digit(s) the code contains. Set lengths for D 2 of 5 to any length, one or two discrete lengths, or lengths within a specific range.

- **One Discrete Length** - Select this option to decode only D 2 of 5 symbols containing a selected length. Select the length using the numeric bar codes in [Appendix D, Numeric Bar Codes](#). For example, to decode only D 2 of 5 symbols with 14 characters, scan **D 2 of 5 - One Discrete Length**, then scan **1** followed by **4**. To correct an error or to change the selection, scan [Cancel on page D-2](#).
- **Two Discrete Lengths** - Select this option to decode only D 2 of 5 symbols containing either of two selected lengths. Select lengths using the numeric bar codes in [Appendix D, Numeric Bar Codes](#). For example, to decode only those D 2 of 5 symbols containing either 2 or 14 characters, select **D 2 of 5 - Two Discrete Lengths**, then scan **0**, **2**, **1**, and then **4**. To correct an error or to change the selection, scan [Cancel on page D-2](#).
- **Length Within Range** - Select this option to decode a D 2 of 5 symbol with a specific length range. Select lengths using numeric bar codes in [Appendix D, Numeric Bar Codes](#). For example, to decode D 2 of 5 symbols containing between 4 and 12 characters, first scan **D 2 of 5 - Length Within Range**. Then scan **0**, **4**, **1**, and **2** (single digit numbers must always be preceded by a leading zero). To correct an error or change the selection, scan [Cancel on page D-2](#).
- **Any Length** - Scan this option to decode D 2 of 5 symbols containing any number of characters within the digital imager scanner capability.

✓ **NOTE** Due to the construction of the D 2 of 5 symbology, it is possible for a scan line covering only a portion of the code to transmit as a complete scan, yielding less data than is encoded in the bar code. To prevent this, select specific lengths (**D 2 of 5 - One Discrete Length**, **Two Discrete Lengths**) for D 2 of 5 applications.

Set Lengths for Discrete 2 of 5 (continued)



D 2 of 5 - One Discrete Length



D 2 of 5 - Two Discrete Lengths



D 2 of 5 - Length Within Range



D 2 of 5 - Any Length

Codabar (NW - 7)

Enable/Disable Codabar

Parameter # 07h

To enable or disable Codabar, scan the appropriate bar code below.

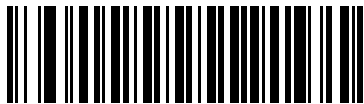

Enable Codabar
(01h)



*Disable Codabar
(00h)

Set Lengths for Codabar

Parameter # L1 = 18h, L2 = 19h

The length of a code refers to the number of characters (i.e., human readable characters), including check digit(s) the code contains. Set lengths for Codabar to any length, one or two discrete lengths, or lengths within a specific range.

- **One Discrete Length** - Select this option to decode only Codabar symbols containing a selected length. Select the length using the numeric bar codes in [Appendix D, Numeric Bar Codes](#). For example, to decode only Codabar symbols with 14 characters, scan **Codabar - One Discrete Length**, then scan **1** followed by **4**. To correct an error or to change the selection, scan [Cancel on page D-2](#).
- **Two Discrete Lengths** - Select this option to decode only Codabar symbols containing either of two selected lengths. Select lengths using the numeric bar codes in [Appendix D, Numeric Bar Codes](#). For example, to decode only Codabar symbols containing either 2 or 14 characters, select **Codabar - Two Discrete Lengths**, then scan **0, 2, 1**, and then **4**. To correct an error or to change the selection, scan [Cancel on page D-2](#).
- **Length Within Range** - Select this option to decode a Codabar symbol with a specific length range. Select lengths using numeric bar codes in [Appendix D, Numeric Bar Codes](#). For example, to decode Codabar symbols containing between 4 and 12 characters, first scan **Codabar - Length Within Range**. Then scan **0, 4, 1**, and **2** (single digit numbers must always be preceded by a leading zero). To correct an error or change the selection, scan [Cancel on page D-2](#).
- **Any Length** - Scan this option to decode Codabar symbols containing any number of characters within the digital imager scanner's capability.

Set Lengths for Codabar (continued)



Codabar - One Discrete Length



Codabar - Two Discrete Lengths



Codabar - Length Within Range



Codabar - Any Length

CLSI Editing

Parameter # 36h

Enable this to strip the start and stop characters and insert a space after the first, fifth, and tenth characters of a 14-character Codabar symbol. Enable this feature if the host system requires this data format.

✓ **NOTE** Symbol length does not include start and stop characters.

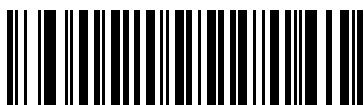

Enable CLSI Editing
(01h)

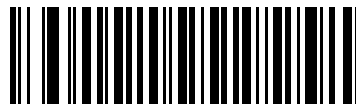

*Disable CLSI Editing
(00h)

NOTIS Editing

Parameter # 37h

Enable this to strip the start and stop characters from a decoded Codabar symbol. Enable this feature if the host system requires this data format.

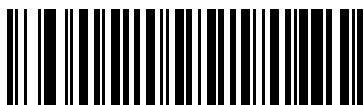

Enable NOTIS Editing
(01h)

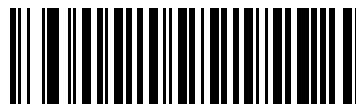

*Disable NOTIS Editing
(00h)

MSI

Enable/Disable MSI

Parameter # 0Bh

To enable or disable MSI, scan the appropriate bar code below.



Enable MSI
(01h)



*Disable MSI
(00h)

Set Lengths for MSI

Parameter # L1 = 1Eh, L2 = 1Fh

The length of a code refers to the number of characters (i.e., human readable characters), including check digit(s) the code contains. Set lengths for MSI to any length, one or two discrete lengths, or lengths within a specific range.

- **One Discrete Length** - Select this option to decode only MSI symbols containing a selected length. Select the length using the numeric bar codes in [Appendix D, Numeric Bar Codes](#). For example, to decode only MSI symbols with 14 characters, scan **MSI - One Discrete Length**, then scan **1** followed by **4**. To correct an error or to change the selection, scan [Cancel on page D-2](#).
- **Two Discrete Lengths** - Select this option to decode only MSI symbols containing either of two selected lengths. Select lengths using the numeric bar codes in [Appendix D, Numeric Bar Codes](#). For example, to decode only MSI symbols containing either 2 or 14 characters, select **MSI - Two Discrete Lengths**, then scan **0**, **2**, **1**, and then **4**. To correct an error or to change the selection, scan [Cancel on page D-2](#).
- **Length Within Range** - Select this option to decode a MSI symbol within a specific length range. Select lengths using numeric bar codes in [Appendix D, Numeric Bar Codes](#). For example, to decode MSI symbols containing between 4 and 12 characters, first scan **MSI - Length Within Range**. Then scan **0**, **4**, **1**, and **2** (enter a leading zero for single digit numbers). To correct an error or change the selection, scan [Cancel on page D-2](#).
- **Any Length** - Scan this option to decode MSI symbols containing any number of characters within the digital imager scanner capability.

✓ **NOTE** Due to the construction of the MSI symbology, it is possible for a scan line covering only a portion of the code to transmit as a complete scan, yielding less data than is encoded in the bar code. To prevent this, select specific lengths (**MSI - One Discrete Length**, **Two Discrete Lengths**) for MSI applications.

Set Lengths for MSI (continued)



MSI - One Discrete Length



MSI - Two Discrete Lengths



MSI - Length Within Range



MSI - Any Length

MSI Check Digits

Parameter # 32h

With MSI symbols, one check digit is mandatory and always verified by the reader. The second check digit is optional. If the MSI codes include two check digits, scan the **Two MSI Check Digits** bar code to enable verification of the second check digit.

See [MSI Check Digit Algorithm on page 10-53](#) for the selection of second digit algorithms.

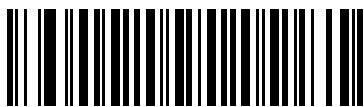

* One MSI Check Digit
(00h)



Two MSI Check Digits
(01h)

Transmit MSI Check Digit(s)

Parameter # 2Eh

Scan a bar code below to transmit MSI data with or without the check digit.

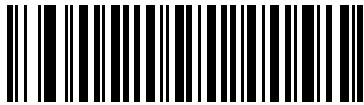

Transmit MSI Check Digit(s) (Enable)
(01h)

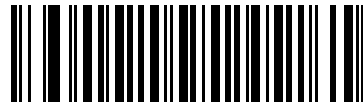

*Do Not Transmit MSI Check Digit(s) (Disable)
(00h)

MSI Check Digit Algorithm

Parameter # 33h

Two algorithms are possible for verifying the second MSI check digit. Select the bar code below corresponding to the algorithm used to encode the check digit.

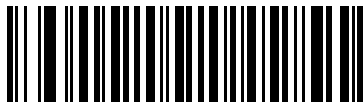

MOD 10/MOD 11
(00h)

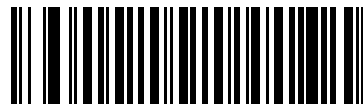

*MOD 10/MOD 10
(01h)

Chinese 2 of 5

Enable/Disable Chinese 2 of 5

Parameter # F0h 98h

To enable or disable Chinese 2 of 5, scan the appropriate bar code below.



Enable Chinese 2 of 5
(01h)

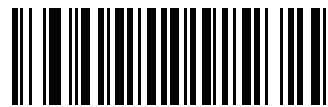

*Disable Chinese 2 of 5
(00h)

Matrix 2 of 5

Enable/Disable Matrix 2 of 5

Parameter # F1h 6Ah

To enable or disable Matrix 2 of 5, scan the appropriate bar code below.



Enable Matrix 2 of 5
(01h)

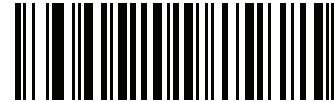

*Disable Matrix 2 of 5
(00h)

Set Lengths for Matrix 2 of 5

Parameter # L1 = F1h 6Bh, L2 = F1h 6Ch

The length of a code refers to the number of characters (i.e., human readable characters), including check digit(s) the code contains. Set lengths for Matrix 2 of 5 to any length, one or two discrete lengths, or lengths within a specific range.

- **One Discrete Length** - Select this option to decode only Matrix 2 of 5 symbols containing a selected length. Select the length using the numeric bar codes in [Appendix D, Numeric Bar Codes](#). For example, to decode only Matrix 2 of 5 symbols with 14 characters, scan **Matrix 2 of 5 - One Discrete Length**, then scan **1** followed by **4**. To correct an error or to change the selection, scan [Cancel on page D-2](#).
- **Two Discrete Lengths** - Select this option to decode only Matrix 2 of 5 symbols containing either of two selected lengths. Select lengths using the numeric bar codes in [Appendix D, Numeric Bar Codes](#). For example, to decode only Matrix 2 of 5 symbols containing either 2 or 14 characters, select **Matrix 2 of 5 - Two Discrete Lengths**, then scan **0, 2, 1**, and then **4**. To correct an error or to change the selection, scan [Cancel on page D-2](#).
- **Length Within Range** - Select this option to decode a Matrix 2 of 5 symbol with a specific length range. Select lengths using the numeric bar codes in [Appendix D, Numeric Bar Codes](#). For example, to decode Matrix 2 of 5 symbols containing between 4 and 12 characters, first scan **Matrix 2 of 5 - Length Within Range**. Then scan **0, 4, 1**, and **2** (enter a leading zero for single digit numbers). To correct an error or change the selection, scan [Cancel on page D-2](#).
- **Any Length** - Scan this option to decode Matrix 2 of 5 symbols containing any number of characters within the digital scanner's capability.

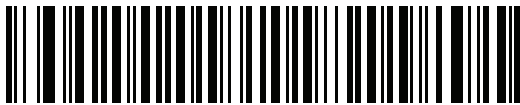

*Matrix 2 of 5 - One Discrete Length



Matrix 2 of 5 - Two Discrete Lengths



Matrix 2 of 5 - Length Within Range



Matrix 2 of 5 - Any Length

Matrix 2 of 5 Redundancy

Parameter # F1h 6Dh

To enable or disable Matrix 2 of 5 redundancy, scan the appropriate bar code below.



Enable Matrix 2 of 5 Redundancy
(01h)



*Disable Matrix 2 of 5 Redundancy
(00h)

Matrix 2 of 5 Check Digit

Parameter # F1h 6Eh

The check digit is the last character of the symbol used to verify the integrity of the data. Scan the appropriate bar code below to transmit the bar code data with or without the Matrix 2 of 5 check digit.



Enable Matrix 2 of 5 Check Digit
(01h)



*Disable Matrix 2 of 5 Check Digit
(00h)

Transmit Matrix 2 of 5 Check Digit

Parameter # F1h 6Fh

Scan a bar code below to transmit Matrix 2 of 5 data with or without the check digit.



Transmit Matrix 2 of 5 Check Digit
(01h)



*Do Not Transmit Matrix 2 of 5 Check Digit
(00h)

Inverse 1D

Parameter # F1h 4Ah

This parameter sets the 1D inverse decoder setting. Options are:

- **Regular Only** - the scanner decodes regular 1D bar codes only.
- **Inverse Only** - the scanner decodes inverse 1D bar codes only.
- **Inverse Autodetect** - the scanner decodes both regular and inverse 1D bar codes.

✓ **NOTE** The default for this option varies by scanner model as follows:
DS6707-SR, DS6707-DC: Regular
DS6707-DP, DS6707-HD: Inverse Autodetect



Regular
(00h)



Inverse Only
(01h)



Inverse Autodetect
(02h)

Postal Codes

US Postnet

Parameter # 59h

To enable or disable US Postnet, scan the appropriate bar code below.



***Enable US Postnet
(01h)**



**Disable US Postnet
(00h)**

US Planet

Parameter # 5Ah

To enable or disable US Planet, scan the appropriate bar code below.



***Enable US Planet
(01h)**



**Disable US Planet
(00h)**

Transmit US Postal Check Digit

Parameter # 5Fh

Select whether to transmit US Postal data, which includes both US Postnet and US Planet, with or without the check digit.



***Transmit US Postal Check Digit
(01h)**



**Do Not Transmit US Postal Check Digit
(00h)**

UK Postal

Parameter # 5Bh

To enable or disable UK Postal, scan the appropriate bar code below.



***Enable UK Postal
(01h)**



**Disable UK Postal
(00h)**

Transmit UK Postal Check Digit

Parameter # 60h

Select whether to transmit UK Postal data with or without the check digit.



***Transmit UK Postal
Check Digit
(01h)**



**Do Not Transmit UK Postal Check Digit
(00h)**

Japan Postal

Parameter # F0h, 22h

To enable or disable Japan Postal, scan the appropriate bar code below.



***Enable Japan Postal
(01h)**



**Disable Japan Postal
(00h)**

Australian Postal

Parameter # F0h, 23h

To enable or disable Australian Postal, scan the appropriate bar code below.



***Enable Australian Postal
(01h)**



**Disable Australian Postal
(00h)**

Netherlands KIX Code

Parameter # F0h, 46h

To enable or disable Netherlands KIX Code, scan the appropriate bar code below.



***Enable Netherlands KIX Code
(01h)**



**Disable Netherlands KIX Code
(00h)**

USPS 4CB/One Code/Intelligent Mail

Parameter # F1h 50h

To enable or disable USPS 4CB/One Code/Intelligent Mail, scan the appropriate bar code below.



Enable USPS 4CB/One Code/Intelligent Mail
(01h)



*Disable USPS 4CB/One Code/Intelligent Mail
(00h)

UPU FICS Postal

Parameter # F1h 63h

To enable or disable UPU FICS Postal, scan the appropriate bar code below.



Enable UPU FICS Postal
(01h)



*Disable UPU FICS Postal
(00h)

GS1 DataBar

The variants of GS1 DataBar are DataBar-14, DataBar Expanded, and DataBar Limited. The limited and expanded versions have stacked variants. Scan the appropriate bar codes to enable or disable each variant of GS1 DataBar.

GS1 DataBar-14

Parameter # F0h 52h.

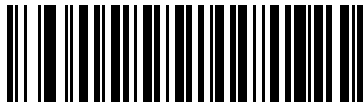

*Enable GS1 DataBar-14
(01h)

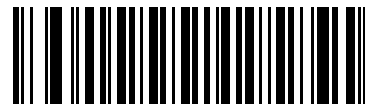

Disable GS1 DataBar-14
(00h)

GS1 DataBar Limited

Parameter # F0h 53h.

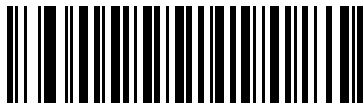

*Enable GS1 DataBar Limited
(01h)

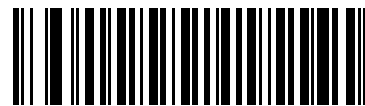

Disable GS1 DataBar Limited
(00h)

GS1 DataBar Expanded

Parameter # F0h 54h.

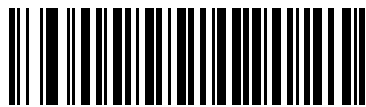

*Enable GS1 DataBar Expanded
(01h)

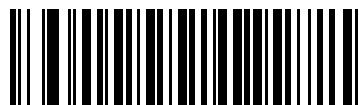

Disable GS1 DataBar Expanded
(00h)

Convert GS1 DataBar to UPC/EAN

Parameter # F0h, 8Dh

This parameter only applies to DataBar-14 and DataBar Limited symbols not decoded as part of a Composite symbol. Enable this to strip the leading '010' from DataBar-14 and DataBar Limited symbols encoding a single zero as the first digit, and report the bar code as EAN-13.

For bar codes beginning with two or more zeros but not six zeros, this parameter strips the leading '0100' and reports the bar code as UPC-A. The UPC-A Preamble parameter that transmits the system character and country code applies to converted bar codes. Note that neither the system character nor the check digit can be stripped.



Enable Convert GS1 DataBar to UPC/EAN
(01h)



*Disable Convert GS1 DataBar to UPC/EAN
(00h)

Composite

Composite CC-C

Parameter # F0h 55h

Scan a bar code below to enable or disable Composite bar codes of type CC-C.



Enable CC-C
(01h)



*Disable CC-C
(00h)

Composite CC-A/B

Parameter # F0h 56h

Scan a bar code below to enable or disable Composite bar codes of type CC-A/B.



Enable CC-A/B
(01h)



*Disable CC-A/B
(00h)

Composite TLC-39

Parameter # F0h 73h

Scan a bar code below to enable or disable Composite bar codes of type TLC-39.

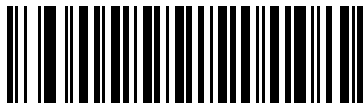

Enable TLC39
(01h)



*Disable TLC39
(00h)

UPC Composite Mode

Parameter # F0h 58h

Select one of three options for “linking” UPC symbols with a 2D symbol during transmission as if they were one symbol:

- Select **UPC Never Linked** to transmit UPC bar codes regardless of whether a 2D symbol is detected.
- Select **UPC Always Linked** to transmit UPC bar codes and the 2D portion. If 2D is not present, the UPC bar code does not transmit.
- If you select **Autodiscriminate UPC Composites**, the scanner determines if there is a 2D portion, then transmits the UPC, as well as the 2D portion if present.



UPC Never Linked
(00h)

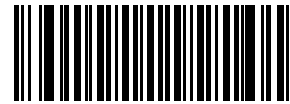

***UPC Always Linked**
(01h)



Autodiscriminate UPC Composites
(02h)

Composite Beep Mode

Parameter # F0h, 8Eh

To select the number of decode beeps when a the scanner decodes a composite bar code, scan the appropriate bar code.



Single Beep after both are decoded
(00h)

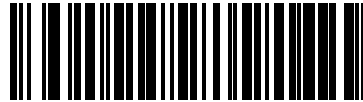

*Beep as each code type is decoded
(01h)

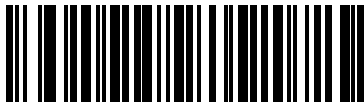

Double Beep after both are decoded
(02h)

GS1-128 Emulation Mode for UCC/EAN Composite Codes

Parameter # F0h, ABh

Select whether to enable or disable this mode.



Enable GS1-128 Emulation Mode for
UCC/EAN Composite Codes
(01h)



*Disable GS1-128 Emulation Mode for
UCC/EAN Composite Codes
(00h)

2D Symbologies

Enable/Disable PDF417

Parameter # 0Fh

To enable or disable PDF417, scan the appropriate bar code below.



***Enable PDF417**
(01h)



Disable PDF417
(00h)

Enable/Disable MicroPDF417

Parameter # E3h

To enable or disable MicroPDF417, scan the appropriate bar code below.



Enable MicroPDF417
(01h)



***Disable MicroPDF417**
(00h)

Code 128 Emulation

Parameter # 7Bh

Enable this parameter to transmit data from certain MicroPDF417 symbols as if it was encoded in Code 128 symbols. You must select [AIM Code ID Character \(01h\) on page 4-15](#) for this parameter to work.

Enable Code 128 Emulation to transmit these MicroPDF417 symbols with one of the following prefixes:

-]C1 if the first codeword is 903-905
-]C2 if the first codeword is 908 or 909
-]C0 if the first codeword is 910 or 911

Disable this to transmit them with one of the following prefixes:

-]L3 if the first codeword is 903-905
-]L4 if the first codeword is 908 or 909
-]L5 if the first codeword is 910 or 911

Scan a bar code below to enable or disable Code 128 Emulation.



NOTE Linked MicroPDF codewords 906, 907, 912, 914, and 915 are not supported. Use GS1 Composites instead.



**Enable Code 128 Emulation
(01h)**



***Disable Code 128 Emulation
(00h)**

Data Matrix

Parameter # F0h, 24h

To enable or disable Data Matrix, scan the appropriate bar code below.



***Enable Data Matrix
(01h)**



**Disable Data Matrix
(00h)**

Data Matrix Inverse

Parameter # F1h 4Ch

This parameter sets the Data Matrix inverse decoder setting. Options are:

- **Regular Only** - the scanner decodes regular Data Matrix bar codes only.
- **Inverse Only** - the scanner decodes inverse Data Matrix bar codes only.
- **Inverse Autodetect** - the scanner decodes both regular and inverse Data Matrix bar codes.

✓ **NOTE** The default for this option varies by scanner model as follows:
DS6707-SR, DS6707-DC: Regular
DS6707-DP, DS6707-HD: Inverse Autodetect



Regular
(00h)



Inverse Only
(01h)



Inverse Autodetect
(02h)

Maxicode

Parameter # F0h, 26h

To enable or disable Maxicode, scan the appropriate bar code below.



***Enable Maxicode
(01h)**



**Disable Maxicode
(00h)**

QR Code

Parameter # F0h,25h

To enable or disable QR Code, scan the appropriate bar code below.



***Enable QR Code
(01h)**



**Disable QR Code
(00h)**

QR Inverse

Parameter # F1h 4Bh

This parameter sets the QR inverse decoder setting. Options are:

- **Regular Only** - the scanner decodes regular QR bar codes only.
- **Inverse Only** - the scanner decodes inverse QR bar codes only.
- **Inverse Autodetect** - the scanner decodes both regular and inverse QR bar codes.

✓ **NOTE** The default for this option varies by scanner model as follows:
DS6707-SR, DS6707-DC: Regular
DS6707-DP, DS6707-HD: Inverse Autodetect



Regular
(00h)



Inverse Only
(01h)



Inverse Autodetect
(02h)

MicroQR

Parameter # F1h 3Dh

To enable or disable MicroQR, scan the appropriate bar code below.



***Enable MicroQR
(01h)**



**Disable MicroQR
(00h)**

Aztec

Parameter # F1h 3Eh

To enable or disable Aztec, scan the appropriate bar code below.



***Enable Aztec
(01h)**



**Disable Aztec
(00h)**

Aztec Inverse

Parameter # F1h 4Dh

This parameter sets the Aztec inverse decoder setting. Options are:

- **Regular Only** - the scanner decodes regular Aztec bar codes only.
- **Inverse Only** - the scanner decodes inverse Aztec bar codes only.
- **Inverse Autodetect** - the scanner decodes both regular and inverse Aztec bar codes.

✓ **NOTE** The default for this option varies by scanner model as follows:
DS6707-SR, DS6707-DC: Regular
DS6707-DP, DS6707-HD: Inverse Autodetect



Regular
(00h)



Inverse Only
(01h)



Inverse Autodetect
(02h)

Redundancy Level

Parameter # 4Eh

The digital imager scanner offers four levels of decode redundancy. Select higher redundancy levels for decreasing levels of bar code quality. As redundancy levels increase, the digital imager scanner's aggressiveness decreases.

Select the redundancy level appropriate for the bar code quality.

Redundancy Level 1

The following code types must be successfully read twice before being decoded:

Table 10-2 *Redundancy Level 1 Codes*

Code Type	Code Length
Codabar	8 characters or less
MSI	4 characters or less
D 2 of 5	8 characters or less
I 2 of 5	8 characters or less

Redundancy Level 2

The following code types must be successfully read twice before being decoded:

Table 10-3 *Redundancy Level 2 Codes*

Code Type	Code Length
All	All

Redundancy Level 3

Code types other than the following must be successfully read twice before being decoded. The following codes must be read three times:

Table 10-4 *Redundancy Level 3 Codes*

Code Type	Code Length
MSI Plessey	4 characters or less
D 2 of 5	8 characters or less
I 2 of 5	8 characters or less
Codabar	8 characters or less

Redundancy Level (continued)

Redundancy Level 4

The following code types must be successfully read three times before being decoded:

Table 10-5 *Redundancy Level 4 Codes*

Code Type	Code Length
All	All

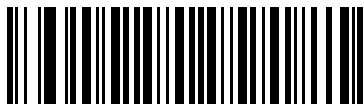

*Redundancy Level 1
(01h)

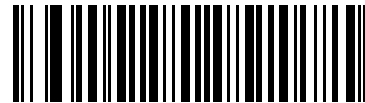

Redundancy Level 2
(02h)

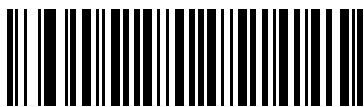

Redundancy Level 3
(03h)



Redundancy Level 4
(04h)

Security Level

Parameter # 4Dh

The digital imager scanner offers four levels of decode security for delta bar codes, which include the Code 128 family, UPC/EAN, and Code 93. Select increasing levels of security for decreasing levels of bar code quality. There is an inverse relationship between security and digital imager scanner aggressiveness, so choose only that level of security necessary for any given application.

- **Security Level 0:** This setting allows the digital imager scanner to operate in its most aggressive state, while providing sufficient security in decoding most “in-spec” bar codes.
- **Security Level 1:** This default setting eliminates most misdecodes.
- **Security Level 2:** Select this option if Security level 1 fails to eliminate misdecodes.
- **Security Level 3:** If you selected Security Level 2 and misdecodes still occur, select this security level. Be advised, selecting this option is an extreme measure against mis-decoding severely out of spec bar codes. Selecting this level of security significantly impairs the decoding ability of the digital imager scanner. If you need this level of security, try to improve the quality of the bar codes.

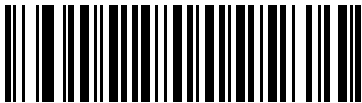

Security Level 0
(00h)



*Security Level 1
(01h)



Security Level 2
(02h)



Security Level 3
(03h)

Intercharacter Gap Size

Parameter # F0h, 7Dh

The Code 39 and Codabar symbologies have an intercharacter gap that is typically quite small. Due to various bar code-printing technologies, this gap can grow larger than the maximum size allowed, preventing the digital imager scanner from decoding the symbol. If this problem occurs, scan **Large Intercharacter Gaps** to tolerate these out-of-specification bar codes.



***Normal Intercharacter Gaps
(06h)**



**Large Intercharacter Gaps
(0Ah)**

Report Version

Scan the bar code below to report the version of software installed in the digital imager scanner.



Report Software Version

Macro PDF Features

Macro PDF is a special feature for concatenating multiple PDF symbols into one file. The digital imager scanner can decode symbols that are encoded with this feature, and can store more than 64 kB of decoded data stored in up to 50 MacroPDF symbols.



CAUTION When printing, keep each Macro PDF sequence separate, as each sequence has unique identifiers. Do not mix bar codes from several Macro PDF sequences, even if they encode the same data. When scanning Macro PDF sequences, scan the entire Macro PDF sequence without interruption. If, when scanning a mixed sequence, the digital imager scanner emits two long low beeps (Low Low) this indicates an inconsistent file ID or inconsistent symbology error.

Flush Macro Buffer

This flushes the buffer of all decoded Macro PDF data stored to that point, transmits it to the host device, and aborts from Macro PDF mode.



Flush Macro PDF Buffer

Abort Macro PDF Entry

This clears all currently-stored Macro PDF data in the buffer without transmission and aborts from Macro PDF mode.



Abort Macro PDF Entry

Chapter 11 Advanced Data Formatting

Introduction

Advanced Data Formatting (ADF) is a means of customizing data before transmission to the host device. Use ADF to edit scan data to suit requirements.

Implement ADF by scanning a related series of bar codes, which begin on [page 11-8](#), or by installing the 123Scan utility (see [Chapter 9, 123Scan](#)) which allows programming the digital imager scanner with ADF rules.

Avoid using ADF formatting with bar codes containing more than 60 characters. To add a prefix or suffix value for such bar codes, use the Add Prefix/Suffix setting. Using ADF with longer bar codes transmits the bar code in segments of length 252 or less (depending on the host selected), and applies the rule to each segment.

Rules: Criteria Linked to Actions

ADF uses **rules** to customize data. These rules perform detailed actions when the data meets certain criteria. One rule may consist of single or multiple criteria applied to single or multiple actions.

For instance, a data formatting rule could be:

Criteria: *When scan data is Code 39, length 12, and data at the start position is the string "129",*
Actions: *pad all sends with zeros to length 8,
send all data up to X,
send a space.*

Scanning a Code 39 bar code of 1299X1559828 transmits the following: 00001299<space>. If you scan a Code 39 bar code of 1299X15598, this rule is ignored because the bar code didn't meet the length criteria.

The rule specifies the editing conditions and requirements before data transmission occurs.

Using ADF Bar Codes

When programming a rule, make sure the rule is logically correct. Plan ahead before scanning.

To program each data formatting rule:

- **Start the Rule.** Scan the [Begin New Rule bar code on page 11-8](#).
- **Specify Criteria.** Scan the bar codes for all pertinent criteria. Criteria can include code type (e.g., Code 128), code length, or data that contains a specific character string (e.g., the digits “129”). See [Criteria on page 11-11](#).
- **Select Actions.** Scan all actions related to, or affecting, these criteria. The actions of a rule specify how to format the data for transmission. See [Actions on page 11-27](#).
- **Save the Rule.** Scan the [Save Rule bar code on page 11-8](#). This places the rule in the “top” position in the rule buffer.
- Use special-purpose bar codes to correct errors during this process. Erase criteria, actions, and entire rules by scanning the appropriate bar code on [page 11-9](#).

[Beeper Definitions on page 2-2](#) guide through the programming steps.

ADF Bar Code Menu Example

This section provides an example of how to enter ADF rules for scan data.

An auto parts distribution center wants to encode manufacturer ID, part number, and destination code into their own Code 128 bar codes. The distribution center also has products that carry UPC bar codes, placed there by the manufacturer. The Code 128 bar codes have the following format:

MMMMMPPPPD

Where: M = Manufacturer ID
 P = Part Number
 D = Destination Code

The distribution center uses a PC with dedicated control characters for manufacturer ID <CTRL M>, part number <CTRL P>, and destination code <CTRL D>. At this center the UPC data is treated as manufacturer ID code.

The following rules must be entered:

When scanning data of code type Code 128, send the next 5 characters, send the manufacturer ID key <CTRL M>, send the next 5 characters, send the part number key <CTRL P>, send the next 2 characters, send the destination code key <CTRL D>.

When scanning data of code type UPC/EAN, send all data, send the manufacturer ID key <CTRL M>.

To enter these rules, use the following steps:

Rule 1: The Code 128 Scanning Rule

Step	Bar Code	On Page	Beep Indication
1	Begin New Rule	11-8	High High
2	Code 128	11-11	High High
3	Send next 5 characters	11-28	High High
4	Send <CTRL M>	11-49	High High
5	Send next 5 characters	11-28	High High
6	Send <CTRL P>	11-49	High High
7	Send next 2 characters	11-27	High High
8	Send <CTRL D>	11-48	High High
9	Save Rule	11-8	High Low High Low

Rule 2: The UPC Scanning Rule

Step	Bar Code	On Page	Beep Indication
1	Begin New Rule	11-8	High High
2	UPC/EAN	11-13	High High
3	Send all remaining data	11-27	High High
4	Send <CTRL M>	11-49	High High
5	Save Rule	11-8	High Low High Low

To correct any errors made while entering this rule, scan the [Quit Entering Rules bar code on page 11-9](#). If you already saved the rule, scan the [Erase Previously Saved Rule bar code on page 11-9](#).

Alternate Rule Sets

Group ADF rules into one of four alternate sets which you can turn on and off when needed. This is useful to format the same message in different ways. For example, a Code 128 bar code contains the following information:

Class (2 digits), Stock Number (8) digits, Price (5 digits)

The bar code might look like this:

245671243701500

where:

Class = 24

Stock Number = 56712437

Price = 01500

Ordinarily, data transmits as follows:

24 (class key)

56712437 (stock key)

01500 (enter key)

But, when there is a sale, send only the following:

24 (class key)

56712437 (stock key)

and the cashier keys the price manually.

To implement this, first enter an ADF rule that applies to the normal situation, such as:

Scan Rule Belongs to Set 1. When scanning a bar code of length 15, send the next 2 characters, send the class key, send the next 8 characters, send the stock key, send the data that remains, send the Enter key.

The “sale” rule may look like this:

Scan Rule Belongs to Set 2. When scanning a bar code of length 15, send the next 2 characters, send the class key, send the next 8 characters, send the stock key.

To switch between the two sets of rules, program a “switching rule” that specifies the type of bar code to be scanned to switch between the rule sets. For example, in the case of the “sale” rule above, the rule programmer wants the cashier to scan the bar code “M” before a sale. To do this, enter the following rule:

When scanning a bar code of length 1 that begins with “M”, select rule set number 1.

Program another rule to switch back.

When scanning a bar code of length 1 that begins with “N”, turn off rule set number 1.

Or include the switching back rules in the “sale” rule:

When scanning a bar code of length 15, send the next 2 characters, send the class key, send the next 8 characters, send the stock key, turn off rule set 1.

For optimal results, scan the [Disable All Rule Sets bar code on page 11-10](#) after programming a rule belonging to an alternate rule set.

In addition to enabling and disabling rule sets within the rules, enable or disable them by scanning the appropriate bar codes on [page 11-10](#).

Rules Hierarchy (in Bar Codes)

The order of programming individual rules is important. Program the most general rule first.

All programmed rules are stored in a buffer. As they are programmed, they are stored at the “top” of a rules list. If you create three rules, the list is configured as follows:

Third Rule
Second Rule
First Rule

When you scan data, the rules list is checked from top to bottom to determine if the criteria matches (and therefore, if the actions occur). Input is modified into the data format specified by the first matching set of criteria it finds. Be sure to program the most general rule first.

For example, if the THIRD rule states:

When scanning a bar code of any length, send all data, then send the ENTER key.

and the SECOND rule states:

When scanning a Code 128 bar code of length 12, send the first four characters, then send the ENTER key, then send all remaining data.

and you scan a Code 128 bar code of length 12, the THIRD rule applies and the SECOND rule appears to not function.

Note that using the standard data editing functions also creates ADF rules. Scan options are entered as ADF rules, and the previous hierarchy also applies to them. For the digital imager scanner, this applies to prefix/suffix programming in the parameter *Scan Data Transmission Format* on page 4-17.

These rules reside in the same “rule list” as ADF rules, so the order of their creation is also important.

Default Rules

Every unit has a default rule to send all scan data. Units with custom software can have one or more default rules burned in. The rules hierarchy checks user programmable rules first, then the default rules. Disable default rules by entering the following general rule in the user programmable buffer:

When receiving scan data, send all data.

Since this rule always applies, ADF never enters the default rules.

ADF Bar Codes

Table 11-1 lists the bar codes available through ADF.

Table 11-1 ADF Bar Codes

Parameter	Page Number
<i>Special Commands</i>	11-8
<i>Pause Duration</i>	11-8
<i>Begin New Rule</i>	11-8
<i>Save Rule</i>	11-8
<i>Erase</i>	11-9
<i>Quit Entering Rules</i>	11-9
<i>Disable Rule Set</i>	11-10
<i>Criteria</i>	11-11
<i>Code Types</i>	11-11
<i>Code Lengths</i>	11-18
<i>1 Character - 6 Characters</i>	11-18
<i>7 Characters - 13 Characters</i>	11-19
<i>14 Characters - 20 Characters</i>	11-20
<i>21 Characters - 27 Characters</i>	11-21
<i>28 Characters - 30 Characters</i>	11-22
<i>Specific String at Start</i>	11-22
<i>Specific String, Any Location</i>	11-23
<i>Specific String Search</i>	11-23

Table 11-1 ADF Bar Codes (Continued)

Parameter	Page Number
<i>Any Message OK</i>	11-23
<i>Numeric Keypad</i>	11-24
<i>Rule Belongs To Set</i>	11-26
<i>Actions</i>	11-27
<i>Send Data</i>	11-27
<i>Send Data Up To Character</i>	11-27
<i>Send Next Character</i>	11-27
<i>Send All Data That Remains</i>	11-27
<i>Send Next 2 Characters - Send Next 20 Characters</i>	11-27
<i>Setup Field(s)</i>	11-30
<i>Move Cursor</i>	11-31
<i>Send Pause</i>	11-32
<i>Skip Ahead</i>	11-33
<i>Skip Back</i>	11-34
<i>Send Preset Value</i>	11-36
<i>Modify Data</i>	11-37
<i>Remove All Spaces</i>	11-37
<i>Crunch All Spaces</i>	11-37
<i>Stop Space Removal</i>	11-37
<i>Remove Leading Zeros</i>	11-37
<i>Stop Zero Removal</i>	11-37
<i>Pad Data with Spaces</i>	11-38
<i>Pad Data with Zeros</i>	11-42
<i>Beeps</i>	11-47
<i>Send Keystroke (Control Characters and Keyboard Characters)</i>	11-47
<i>Keyboard Characters</i>	11-52
<i>Send ALT Characters</i>	11-66
<i>Send Keypad Characters</i>	11-71

Table 11-1 ADF Bar Codes (Continued)

Parameter	Page Number
<i>Send Function Key</i>	11-76
<i>Send F1 Key - Send F24 Key</i>	11-76
<i>Send PF1 Key - Send PF30 Key</i>	11-79
<i>Send Right Control Key</i>	11-83
<i>Send Graphic User Interface (GUI) Characters</i>	11-84
<i>Send GUI 0 - Send GUI 9</i>	11-84
<i>Send GUI A - Send GUI Z</i>	11-85
<i>Turn On/Off Rule Sets</i>	11-89
<i>Alphanumeric Keyboard</i>	11-91
<i>Space - ' </i>	11-91
<i>0 - 9</i>	11-95
<i>A - Z</i>	11-96
<i>Cancel</i>	11-100
<i>End of Message</i>	11-100
<i>a - z</i>	11-100
<i>{ - ~</i>	11-104

Special Commands

Pause Duration

This parameter, along with the Send Pause parameter on [page 11-32](#), inserts a pause in the data transmission. Set the pause by scanning a two-digit number (i.e., two bar codes) representing a 0.1 second interval in the range of 0.1 to 9.9. For example, scan bar codes **0** and **1** to insert a 0.1 second pause; **0** and **5** to insert a 0.5 second delay. The default is 1 second. See [Appendix D, Numeric Bar Codes](#). To correct an error or change a selection, scan [Cancel on page D-2](#).



Pause Duration

Begin New Rule

Scan the bar code below to start entering a new rule



Begin New Rule

Save Rule

Scan the bar code below to save the rule.



Save Rule

Erase

Use these bar codes to erase criteria, actions, or rules.



Erase Criteria And Start Again



Erase Actions And Start Again



Erase Previously Saved Rule



Erase All Rules

Quit Entering Rules

Scan the bar code below to quit entering rules.



Quit Entering Rules

Disable Rule Set

Use these bar codes to disable rule sets.



Disable Rule Set 1



Disable Rule Set 2



Disable Rule Set 3



Disable Rule Set 4



Disable All Rule Sets

Criteria

Code Types

Select all code types to be affected by the rule. Scan all selected codes in succession, before selecting other criteria. *To select all code types, do not scan any code type.*



Code 39



Codabar



GS1 DataBar-14



GS1 DataBar Limited



GS1 DataBar Expanded



Code 128



D 2 OF 5

Code Types (continued)



IATA 2 OF 5



I 2 OF 5



Code 93



UPC-A



UPC-E



EAN-8



EAN-13



ISSN

Code Types (continued)



MSI



GS1-128



UPC-E1



Bookland EAN



Trioptic Code 39

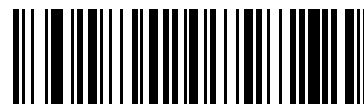

Code 11



Code 32

Code Types (continued)



ISBT 128



Coupon Code



Chinese 2 of 5



Matrix 2 of 5



US Postnet

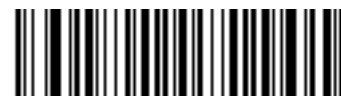

US Planet



UK Postal

Code Types (continued)



Japan Postal



Australian Postal



Netherlands KIX Code



USPS 4CB/One Code/Intelligent Mail



UPU FICS Postal



PDF417



MicroPDF

Code Types (continued)



Macro PDF



Macro MicroPDF



MaxiCode



Data Matrix



QR Code



MicroQR



TLC 39

Code Types (continued)



UPC/EAN Composites



GS1 DataBar and GS1-128 Composites



Aztec



Aztec Rune



NOTE When selecting composite bar codes, enable AIM IDs if parsing UPC or EAN composite data, or data from an application that uses symbol separators.

Code Lengths

Scan these bar codes to define the number of characters the selected code type must contain. Select one length per rule only. *Do not select any code length to select code types of any length.*



1 Character



2 Characters



3 Characters



4 Characters



5 Characters



6 Characters

Code Lengths (continued)



7 Characters



8 Characters



9 Characters



10 Characters



11 Characters



12 Characters



13 Characters

Code Lengths (continued)



14 Characters



15 Characters



16 Characters



17 Characters



18 Characters



19 Characters



20 Characters

Code Lengths (continued)



21 Characters



22 Characters



23 Characters



24 Characters



25 Characters



26 Characters



27 Characters

Code Lengths (continued)



28 Characters



29 Characters



30 Characters

Message Containing A Specific Data String

Use this feature to select whether the formatting affects data that begins with a specific character or data string, or contains a specific character or data string.

There are 5 features:

- Specific String at Start
- Specific String, Any Location
- Specific String Search
- Any Message OK
- Rule Belongs to Set

Specific String at Start

1. Scan the following bar code.
2. Scan the bar codes representing the desired character or characters (up to a total of 8) using the [Alphanumeric Keyboard on page 11-91](#).
3. Scan [End of Message bar code on page 11-100](#).



Specific String At Start

Specific String, Any Location

1. Scan the following bar code.
2. Enter a location by scanning a two-digit number representing the **position** (use a leading “zero” if necessary) using the [Numeric Keypad on page 11-24](#).
3. Scan the bar codes representing the desired character or characters (up to a total of 8) using the [Alphanumeric Keyboard on page 11-91](#).
4. Scan [End of Message bar code on page 11-100](#).



Specific String Any Location

Specific String Search

1. Scan the following bar code.
2. Scan the bar codes representing the desired character or characters (up to a total of 10) using the [Alphanumeric Keyboard on page 11-91](#).
3. Scan [End of Message bar code on page 11-100](#).

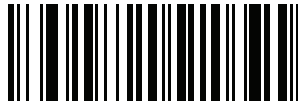

Specific String Search

Any Message OK

Do not scan a bar code to format all selected code types, regardless of information contained.

Numeric Keypad

Do not confuse bar codes on this page with those on the alphanumeric keyboard.



0



1



2



3



4



5



6

Numeric Keypad (continued)



7



8



9



Cancel

Rule Belongs To Set

Select the set to which a rule belongs. There are four possible rule sets. See [Alternate Rule Sets on page 11-3](#) for more information about rule sets.



Rule Belongs To Set 1



Rule Belongs To Set 2



Rule Belongs To Set 3



Rule Belongs To Set 4

Actions

Select how to format the data for transmission.

Send Data

Send all data that follows, send all data up to a specific character selected from the [Alphanumeric Keyboard on page 11-91](#), or send the next X characters. Note that only bar codes for **Send Next 1 to 20** appear here, and can be scanned multiple times to send values greater than 20. For instance, to send the next 28 characters, scan **Send Next 20 Characters**, then **Send Next 8 Characters**.



Send Data Up To Character



Send All Data That Remains



Send Next Character



Send Next 2 Characters



Send Next 3 Characters



Send Next 4 Characters

Send Data (continued)



Send Next 5 Characters



Send Next 6 Characters



Send Next 7 Characters



Send Next 8 Characters



Send Next 9 Characters



Send Next 10 Characters



Send Next 11 Characters

Send Data (continued)



Send Next 12 Characters



Send Next 13 Characters



Send Next 14 Characters



Send Next 15 Characters



Send Next 16 Characters



Send Next 17 Characters



Send Next 18 Characters

Send Data (continued)

Send Next 19 Characters



Send Next 20 Characters

Setup Field(s)

Table 11-2 Setup Field(s) Definitions

Parameter	Description	Page
Move Cursor		
Move Cursor To a Character	Scan <i>Move Cursor To Character</i> , then any printable ASCII character from the <i>Alphanumeric Keyboard on page 11-91</i> . This moves the cursor to the position after the matching character. If the character is not there, the rule fails and ADF tries the next rule.	11-31
Move Cursor to Start of Data	Scan this bar code to move cursor to the beginning of the data.	11-31
Move Cursor Past a Character	This action moves the cursor past all sequential occurrences of a selected character. For example, if the selected character is 'A', then the cursor moves past 'A', 'AA', 'AAA', etc. Scan <i>Move Cursor Past Character</i> , then select a character from the <i>Alphanumeric Keyboard</i> . If the character is not there, the cursor does not move (i.e., has no effect).	11-32
Move Cursor Past a Specific String	This action moves the cursor past the first occurrence of a selected string. Scan <i>Move Cursor Past Specific String</i> , then select the character(s) (up to 10) using the <i>Alphanumeric Keyboard</i> . Scan the <i>End of Message bar code on page 11-100</i> .	11-32
Move Cursor to Specific String and Replace	This action moves the cursor to the first occurrence of a selected string and replaces the string with another user-defined string. Scan <i>Move Cursor to Specific String and Replace</i> , then enter an alphanumeric string representing the character(s) (up to 10) to match and delete using the <i>Alphanumeric Keyboard</i> . Scan the <i>End of Message bar code on page 11-100</i> . Enter another alphanumeric string representing the character(s) (up to 10) to insert using the <i>Alphanumeric Keyboard</i> . Scan <i>End of Message</i> .	11-32

Table 11-2 Setup Field(s) Definitions (Continued)

Parameter	Description	Page
Move Cursor to Last Occurrence of String and Replace All	This action replaces all occurrences of a selected string with another user-defined string, and moves the cursor to the beginning of the last occurrence. Scan Move Cursor to Last Occurrence of String and Replace All , then enter an alphanumeric string representing the character(s) (up to 10) to match and delete using the Alphanumeric Keyboard . Scan the End of Message bar code on page 11-100 . Enter another alphanumeric string representing the character(s) (up to 10) to insert using the Alphanumeric Keyboard . Scan End of Message .	11-32
Skip to End	Scan Skip to End to move cursor to the end of the data.	11-32
Skip Ahead “N” Characters	Scan one of these bar codes to select the number of positions ahead to move the cursor.	11-33
Skip Back “N” Characters	Scan one of these bar codes to select the number of positions back to move the cursor.	11-34
Send Preset Value	Send Values 1 through 6 by scanning the appropriate bar code. Set these values using the prefix/suffix values in Table 8-4 on page 8-19 . Value 1 = Scan Suffix Value 2 = Scan Prefix Values 3-6 are not applicable	11-34

Move Cursor

Scan a bar code below to move the cursor in relation to a specified character. Then enter a character by scanning a bar code from the [Alphanumeric Keyboard on page 11-91](#).

✓ **NOTE** If there is no match and the rule fails, the next rule is checked.



Move Cursor To Character



Move Cursor To Start

Move Cursor (continued)



Move Cursor Past Character

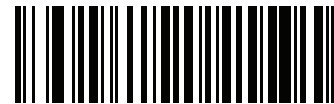

Move Cursor Past
Specific String

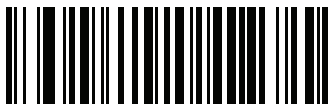

Move Cursor to
Specific String and Replace



Move Cursor to Last Occurrence
of String and Replace All



Skip to End

Send Pause

Scan the bar code below to insert a pause in the transmission of data. [Pause Duration on page 11-8](#) controls the length of this pause.



Send Pause

Skip Ahead

Use the following bar codes to skip ahead characters.



Skip Ahead 1 Character



Skip Ahead 2 Characters



Skip Ahead 3 Characters



Skip Ahead 4 Characters



Skip Ahead 5 Characters



Skip Ahead 6 Characters



Skip Ahead 7 Characters

Skip Ahead (continued)



Skip Ahead 8 Characters



Skip Ahead 9 Characters



Skip Ahead 10 Characters

Skip Back

Use the following bar codes to skip back characters.



Skip Back 1 Character



Skip Back 2 Characters



Skip Back 3 Characters

Skip Back (continued)



Skip Back 4 Characters



Skip Back 5 Characters



Skip Back 6 Characters



Skip Back 7 Characters



Skip Back 8 Characters



Skip Back 9 Characters

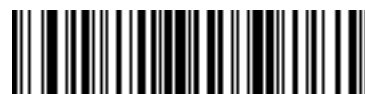

Skip Back 10 Characters

Send Preset Value

Use these bar codes to send preset values. Set these values using the Scan Prefix and Scan Suffix bar codes on [page 4-16](#).

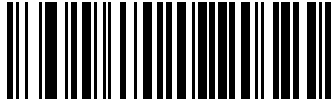

Send Prefix

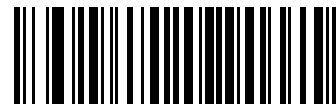

Send Suffix

Modify Data

Modify data as described below. The following actions work for all send commands that follow it within a rule. Programming *pad zeros to length 6, send next 3 characters, stop padding, send next 5 characters*, adds three zeros to the first send, and the next send is unaffected by the padding. These options do not apply to the **Send Keystroke** or **Send Preset Value** options.

Remove All Spaces

To remove all spaces in the send commands that follow, scan the bar code below.



Remove All Spaces

Crunch All Spaces

To leave one space between words, scan the bar code below. This also removes all leading and trailing spaces.



Crunch All Spaces

Stop Space Removal

Scan the bar code below to disable space removal.



Stop Space Removal

Remove Leading Zeros

Scan the bar code below to remove all leading zeros.



Remove Leading Zeros

Stop Zero Removal

Scan the bar code below to disable the removal of zeros.



Stop Zero Removal

Pad Data with Spaces

To pad data to the left, scan the bar code containing the desired number of spaces. **Send** commands activate this parameter.



Pad Spaces To Length 1



Pad Spaces To Length 2



Pad Spaces To Length 3



Pad Spaces To Length 4



Pad Spaces To Length 5



Pad Spaces To Length 6



Pad Spaces To Length 7

Pad Data with Spaces (continued)



Pad Spaces To Length 8



Pad Spaces To Length 9



Pad Spaces To Length 10



Pad Spaces To Length 11



Pad Spaces To Length 12



Pad Spaces To Length 13



Pad Spaces To Length 14

Pad Data with Spaces (continued)



Pad Spaces To Length 15



Pad Spaces To Length 16



Pad Spaces To Length 17



Pad Spaces To Length 18



Pad Spaces To Length 19



Pad Spaces To Length 20



Pad Spaces To Length 21

Pad Data with Spaces (continued)



Pad Spaces To Length 22



Pad Spaces To Length 23



Pad Spaces To Length 24



Pad Spaces To Length 25



Pad Spaces To Length 26



Pad Spaces To Length 27



Pad Spaces To Length 28

Pad Data with Spaces (continued)



Pad Spaces To Length 29



Pad Spaces To Length 30



Stop Pad Spaces

Pad Data with Zeros

To pad data to the left, scan the bar code containing the desired number of zeros. **Send** commands activate this parameter.



Pad Zeros To Length 1



Pad Zeros To Length 2



Pad Zeros To Length 3

Pad Data with Zeros (continued)



Pad Zeros To Length 4



Pad Zeros To Length 5



Pad Zeros To Length 6



Pad Zeros To Length 7



Pad Zeros To Length 8



Pad Zeros To Length 9



Pad Zeros To Length 10

Pad Data with Zeros (continued)



Pad Zeros To Length 11



Pad Zeros To Length 12



Pad Zeros To Length 13



Pad Zeros To Length 14



Pad Zeros To Length 15



Pad Zeros To Length 16



Pad Zeros To Length 17

Pad Data with Zeros (continued)



Pad Zeros To Length 18



Pad Zeros To Length 19



Pad Zeros To Length 20



Pad Zeros To Length 21



Pad Zeros To Length 22



Pad Zeros To Length 23



Pad Zeros To Length 24

Pad Data with Zeros (continued)



Pad Zeros To Length 25



Pad Zeros To Length 26



Pad Zeros To Length 27



Pad Zeros To Length 28



Pad Zeros To Length 29



Pad Zeros To Length 30



Stop Pad Zeros

Beeps

Select a beep sequence for each ADF rule.



Beep Once



Beep Twice



Beep Three Times

Send Keystroke (Control Characters and Keyboard Characters)

Control Characters

Scan a **Send** bar code for the keystroke to send.



Send Control 2



Send Control A



Send Control B

Control Characters (continued)



Send Control C



Send Control D



Send Control E



Send Control F



Send Control G



Send Control H



Send Control I

Control Characters (continued)



Send Control J



Send Control K



Send Control L



Send Control M



Send Control N



Send Control O



Send Control P

Control Characters (continued)



Send Control Q



Send Control R



Send Control S



Send Control T



Send Control U



Send Control V



Send Control W

Control Characters (continued)



Send Control X



Send Control Y



Send Control Z



Send Control [



**Send Control **



Send Control]

Control Characters (continued)



Send Control 6



Send Control -

Keyboard Characters

Scan a **Send** bar code for the keyboard characters to send.



Send Space



Send !



Keyboard Characters (continued)



Send \$



Send %



Send &



Send ' (apostrophe)



Send (/)



Send (/)



Send *

Keyboard Characters (continued)



Send +



Send ,



Send -



Send .



Send /



Send 0



Send 1

Keyboard Characters (continued)



Send 2



Send 3



Send 4



Send 5



Send 6



Send 7



Send 8

Keyboard Characters (continued)



Send 9



Send :



Send ;



Send <



Send =



Send >



Send ?

Keyboard Characters (continued)



Send @



Send A



Send B



Send C



Send D



Send E



Send F

Keyboard Characters (continued)



Send G



Send H



Send I



Send J



Send K



Send L



Send M

Keyboard Characters (continued)



Send N



Send O



Send P



Send Q



Send R



Send S



Send T

Keyboard Characters (continued)



Send U



Send V



Send W



Send X



Send Y



Send Z



Send [

Keyboard Characters (continued)



Send \



Send]



Send ^



Send _



Send `



Send a



Send b

Keyboard Characters (continued)



Send c



Send d



Send e



Send f



Send g



Send h



Send i

Keyboard Characters (continued)



Send j



Send k



Send l



Send m



Send n



Send o



Send p

Keyboard Characters (continued)



Send q



Send r



Send s



Send t



Send u



Send v



Send w

Keyboard Characters (continued)



Send x



Send y



Send z



Send {



Send |



Send }



Send ~

Send ALT Characters



Send Alt 2



Send Alt A



Send Alt B



Send Alt C



Send Alt D



Send Alt E



Send Alt F

Send ALT Characters (continued)



Send Alt G



Send Alt H



Send Alt I



Send Alt J



Send Alt K



Send Alt L



Send Alt M

Send ALT Characters (continued)



Send Alt N



Send Alt O



Send Alt P



Send Alt Q



Send Alt R



Send Alt S



Send Alt T

Send ALT Characters (continued)



Send Alt U



Send Alt V



Send Alt W



Send Alt X



Send Alt Y



Send Alt Z



Send Alt [

Send ALT Characters (continued)



**Send Alt **



Send Alt]

Send Keypad Characters



Send Keypad *



Send Keypad +



Send Keypad -



Send Keypad .



Send Keypad /



Send Keypad 0



Send Keypad 1

Send Keypad Characters (continued)



Send Keypad 2



Send Keypad 3



Send Keypad 4



Send Keypad 5



Send Keypad 6



Send Keypad 7



Send Keypad 8

Send Keypad Characters (continued)



Send Keypad 9



Send Keypad Enter



Send Keypad Numlock



Send Break Key



Send Delete Key



Send Page Up Key



Send End Key

Send Keypad Characters (continued)



Send Page Down Key



Send Pause Key



Send Scroll Lock Key



Send Backspace Key



Send Tab Key



Send Print Screen Key



Send Insert Key

Send Keypad Characters (continued)



Send Home Key



Send Enter Key



Send Escape Key



Send Up Arrow Key



Send Down Arrow Key



Send Left Arrow Key



Send Right Arrow Key

Send Function Key



Send F1 Key



Send F2 Key



Send F3 Key



Send F4 Key



Send F5 Key



Send F6 Key



Send F7 Key

Send Function Key (continued)



Send F8 Key



Send F9 Key



Send F10 Key



Send F11 Key



Send F12 Key



Send F13 Key



Send F14 Key

Send Function Key (continued)



Send F15 Key



Send F16 Key



Send F17 Key



Send F18 Key



Send F19 Key



Send F20 Key



Send F21 Key

Send Function Key (continued)



Send F22 Key



Send F23 Key



Send F24 Key



Send PF1 Key



Send PF2 Key



Send PF3 Key



Send PF4 Key

Send Function Key (continued)



Send PF5 Key



Send PF6 Key



Send PF7 Key



Send PF8 Key



Send PF9 Key



Send PF10 Key



Send PF11 Key

Send Function Key (continued)



Send PF12 Key



Send PF13 Key



Send PF14 Key



Send PF15 Key



Send PF16 Key



Send PF17 Key



Send PF18 Key

Send Function Key (continued)



Send PF19 Key



Send PF20 Key



Send PF21 Key



Send PF22 Key



Send PF23 Key



Send PF24 Key



Send PF25 Key

Send Function Key (continued)



Send PF26 Key



Send PF27 Key



Send PF28 Key



Send PF29 Key



Send PF30 Key

Send Right Control Key

The “Send Right Control Key” action will send a tap (press and release) of the Right Control Key.



Send Right Control Key

Send Graphic User Interface (GUI) Characters

The Send Graphic User Interface Character actions tap the specified key while holding the System Dependent Graphic User Interface (GUI) key. The definition of the Graphic User Interface key depends on the attached system.

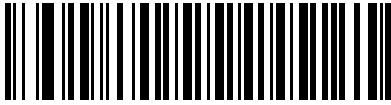

Send GUI 0

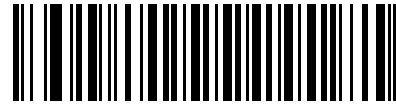

Send GUI 1

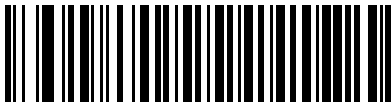

Send GUI 2



Send GUI 3



Send GUI 4

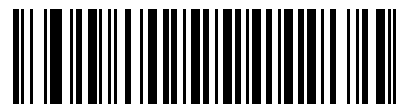

Send GUI 5

Send Graphic User Interface (GUI) Characters (continued)



Send GUI 6

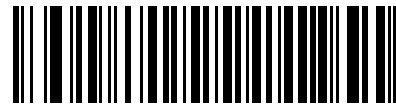

Send GUI 7

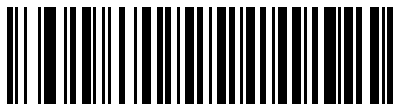

Send GUI 8

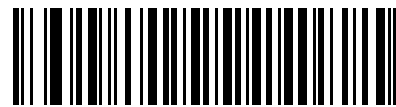

Send GUI 9

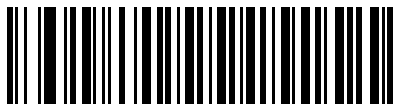

Send GUI A

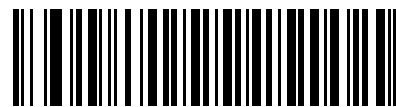

Send GUI B



Send GUI C

Send Graphic User Interface (GUI) Characters (continued)



Send GUI D

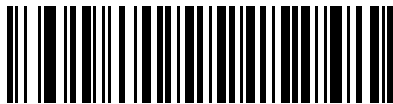

Send GUI E

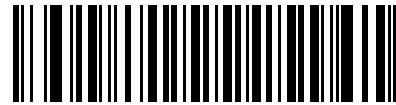

Send GUI F



Send GUI G



Send GUI H



Send GUI I

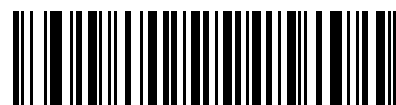

Send GUI J

Send Graphic User Interface (GUI) Characters (continued)



Send GUI K

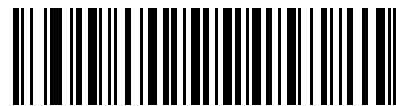

Send GUI L



Send GUI M

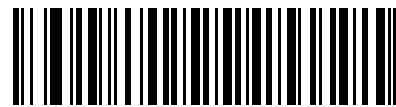

Send GUI N

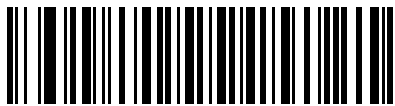

Send GUI O

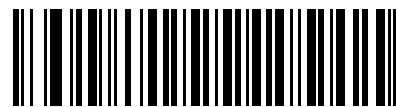

Send GUI P



Send GUI Q

Send Graphic User Interface (GUI) Characters (continued)



Send GUI R

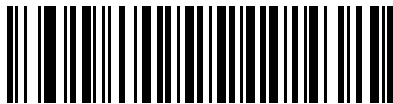

Send GUI S

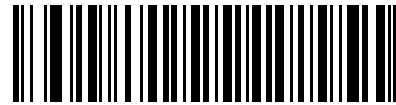

Send GUI T



Send GUI U

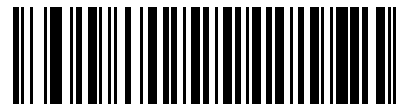

Send GUI V



Send GUI W

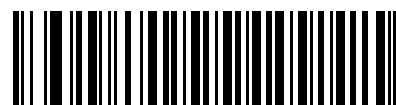

Send GUI X

Send Graphic User Interface (GUI) Characters (continued)



Send GUI Y

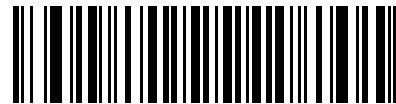

Send GUI Z

Turn On/Off Rule Sets

Use these bar codes to turn rule sets on and off.



Turn On Rule Set 1



Turn On Rule Set 2



Turn On Rule Set 3



Turn On Rule Set 4

Turn On/Off Rule Sets (continued)

Use these bar codes to turn rule sets on and off.

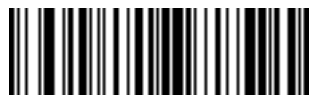

Turn Off Rule Set 1



Turn Off Rule Set 2

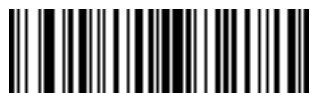

Turn Off Rule Set 3



Turn Off Rule Set 4

Alphanumeric Keyboard



Space



#



\$



%



*

(Single Close Quote)



+



-

(Dash)

Alphanumeric Keyboard (continued)

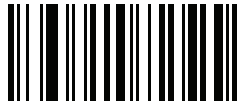

,
(Comma)



.



!



/



&



“



(



{

Alphanumeric Keyboard (continued)



)



:



;



<



=



>



?

Alphanumeric Keyboard (continued)



@



[



\



]



^



(Underscore)



'
(Single Open Quote)

Alphanumeric Keyboard (continued)

✓ **NOTE** Do not confuse the numeric bar codes below with those on the numeric keypad.



0



1



2



3



4



5

Alphanumeric Keyboard (continued)



6



7



8



9



A



B



C

Alphanumeric Keyboard (continued)



D



E



F



G



H



I



J

Alphanumeric Keyboard (continued)



K



L



M



N



O



P



Q

Alphanumeric Keyboard (continued)



R



S



T



U



V



W



X

Alphanumeric Keyboard (continued)



Y



Z



Cancel



End of Message



a



b



c

Alphanumeric Keyboard (continued)



d



e



f



g



h



i



j

Alphanumeric Keyboard (continued)



k



l



m



n



o



p



q

Alphanumeric Keyboard (continued)



r



s



t



u



v



w



x

Alphanumeric Keyboard (continued)



y



z



{



|



}



~

Appendix A Standard Default Parameters

Table A-1 Standard Default Parameters Table

Parameter	Parameter Number	Default	Page Number
User Preferences			
Set Default Parameter		Restore Defaults	4-4
Parameter Scanning	ECh	Enable	4-5
Beeper Tone	91h	Medium	4-5
Beeper Volume	8Ch	High	4-5
Power Mode	80h	Continuous On	4-6
Time Delay to Low Power Mode	92h	1 Minute	4-7
Trigger Mode	8Ah	Auto Aim	4-8
Picklist Mode	F0h, 92h	Disabled Always	4-9
Decode Session Timeout	88h	9.9 Sec	4-10
Timeout Between Decodes, Same Symbol	89h	0.6 Sec	4-10
Beep After Good Decode	38h	Enable	4-11
Decoding Illumination	F0h, 2Ah	Enable	4-11
DP Illumination	F1h, 3Bh	Auto	4-12
Decode Aiming Pattern	F0h, 32h	Enable	4-13
Fuzzy 1D Processing	F1h, 02h	Enable	4-13
Decode Mirror Images	F1h, 19h	Never	4-14

¹User selection is required to configure this interface and this is the most common selection.

Table A-1 Standard Default Parameters Table (Continued)

Parameter	Parameter Number	Default	Page Number
Miscellaneous Scanner Options			
Transmit Code ID Character	2Dh	None	4-15
Prefix Value	63h, 69h	7013 <CR><LF>	4-16
Suffix 1 Value Suffix 2 Value	62h, 68h 64h, 6Ah	7013 <CR><LF>	4-16
Scan Data Transmission Format	EBh	Data as is	4-17
FN1 Substitution Values	67h, 6Dh	Set	4-18
Transmit "No Read" Message	5Eh	Disable	4-19
Imaging Preferences			
Operational Modes	N/A	N/A	5-4
Low Light Enhancement	F1h 64h	Disable	5-5
Presentation Mode Field of View	F1h 61h	Default (Reduced)	5-5
Image Capture Autoexposure	F0h 68h	Enable	5-6
Image Capture Illumination	F0h 69h	Enable	5-6
Illumination Bank Control	F1h 3Bh	Full	5-7
Fixed Exposure	F4h, F1h, 37h	100	5-8
Fixed Gain	F1h 38h	50	5-8
Gain Exposure Priority for Snapshot Mode	F1h 32h	Autodetect	5-9
Snapshot Mode Timeout	F0h 43h	0 (30 seconds)	5-10
Snapshot Aiming Pattern	F0h 2Ch	Enable	5-10
Image Cropping	F0h 2Dh	Disable	5-11
Crop to Pixel Addresses	F4h F0h 3Bh; F4h F0h 3Ch; F4h F0h 3Dh; F4h F0h 3Eh	0 top, 0 left, 1023 bottom, 1279 right	5-12
Image Size (Number of Pixels)	F0h 2Eh	Full	5-13
Image Brightness (Target White)	F0h 86h	180	5-14
JPEG Image Options	F0h 2Bh	Quality	5-14
JPEG Target File Size	F1h 31h	160 kB	5-15

¹User selection is required to configure this interface and this is the most common selection.

Table A-1 Standard Default Parameters Table (Continued)

Parameter	Parameter Number	Default	Page Number
JPEG Quality and Size Value	F0h 31h	65	5-15
Image Enhancement	F1h 34h	Off (0)	5-16
Image File Format Selection	F0h 30h	JPEG	5-17
Bits per Pixel (BPP)	F0h 2Fh	8 BPP	5-18
Signature Capture	5Dh	Disable	5-19
Signature Capture Image File Format Selection	F0h 39h	JPEG	5-20
Signature Capture Bits per Pixel (BPP)	F0h 3Ah	8 BPP	5-21
Signature Capture Width	F4h F0h 6Eh	400	5-22
Signature Capture Height	F4h F0h 6Fh	100	5-22
Signature Capture JPEG Quality	F0h A5h	65	5-22
Video View Finder	F0h 44h	Disable	5-23
Target Video Frame Size	F0h 48h	2200 bytes	5-23
Video View Finder Image Size	F0h 49h	1700 bytes	5-24
SSI Host Preferences			
Baud Rate	9Ch	9600	6-4
Parity	9Eh	None	6-6
Check Parity	97h	Enable	6-7
Software Handshaking	9Fh	ACK/NAK	6-7
Host RTS Line State	9Ah	Low	6-8
Decode Data Packet Format	EEh	Send Raw Decode Data	6-8
Stop Bits	9Dh	1	6-9
Host Serial Response Time-out	9Bh	2 sec	6-10
Host Character Time-out	EFh	200 msec	6-11
Multipacket Option	F0h 4Eh	Option 1	6-12
Interpacket Delay	F0h 4Fh	0 ms	6-13
SSI Event Reporting			
Decode Event	F0h 00h	Disable	6-14
Boot Up Event	F0h 02h	Disable	6-15

¹User selection is required to configure this interface and this is the most common selection.

Table A-1 Standard Default Parameters Table (Continued)

Parameter	Parameter Number	Default	Page Number
Parameter Event	F0h 03h	Disable	6-15
USB Host Parameters			
USB Device Type		HID Keyboard Emulation	7-4
Symbol Native API (SNAPI) Status Handshaking		Enable	7-5
USB Country Keyboard Types (Country Codes)		North American	7-6
USB Keystroke Delay		No Delay	7-8
USB CAPS Lock Override		Disable	7-8
USB Ignore Unknown Characters		Enable	7-9
Emulate Keypad		Disable	7-9
Emulate Keypad with Leading Zero		Disable	7-10
USB Keyboard FN1 Substitution		Disable	7-10
Function Key Mapping		Disable	7-11
Simulated Caps Lock		Disable	7-11
Convert Case		No Case Conversion	7-12
RS-232 Host Parameters			
RS-232 Host Types		Standard ¹	8-6
Baud Rate		9600	8-7
Parity Type		None	8-9
Stop Bit Select		1 Stop Bit	8-10
Data Bits		8-Bit	8-10
Check Receive Errors		Enable	8-11
Hardware Handshaking		None	8-11
Software Handshaking		None	8-13
Host Serial Response Time-out		2 Sec	8-15
RTS Line State		Low RTS	8-16
Beep on <BEL>		Disable	8-16
Intercharacter Delay		0 msec	8-17

¹User selection is required to configure this interface and this is the most common selection.

Table A-1 Standard Default Parameters Table (Continued)

Parameter	Parameter Number	Default	Page Number
Nixdorf Beep/LED Options		Normal Operation	8-18
Ignore Unknown Characters		Send Bar Code	8-18
123Scan Configuration Tool			
123Scan Configuration		None ¹	9-1
UPC/EAN			
UPC-A	01h	Enable	10-7
UPC-E	02h	Enable	10-7
UPC-E1	0Ch	Disable	10-8
EAN-8/JAN 8	04h	Enable	10-8
EAN-13/JAN 13	03h	Enable	10-9
Bookland EAN	53h	Disable	10-9
Decode UPC/EAN/JAN Supplementals (2 and 5 digits)	10h	Ignore	10-10
User-Programmable Supplementals Supplemental 1: Supplemental 2:	F1h 43h F1h 44h		10-13
UPC/EAN/JAN Supplemental Redundancy	50h	10	10-14
Transmit UPC-A Check Digit	28h	Enable	10-14
Transmit UPC-E Check Digit	29h	Enable	10-15
Transmit UPC-E1 Check Digit	2Ah	Enable	10-15
UPC-A Preamble	22h	System Character	10-16
UPC-E Preamble	23h	System Character	10-17
UPC-E1 Preamble	24h	System Character	10-18
Convert UPC-E to A	25h	Disable	10-19
Convert UPC-E1 to A	26h	Disable	10-19
EAN-8/JAN-8 Extend	27h	Disable	10-20
Bookland ISBN Format	F1h 40h	ISBN-10	10-21
UCC Coupon Extended Code	55h	Disable	10-22
ISSN EAN	F1h 69h	Disable	10-22

¹User selection is required to configure this interface and this is the most common selection.

Table A-1 Standard Default Parameters Table (Continued)

Parameter	Parameter Number	Default	Page Number
Code 128			
Code 128	08h	Enable	10-23
Set Length(s) for Code 128	D1h D2h	Any Length	10-23
GS1-128 (formerly UCC/EAN-128)	0Eh	Enable	10-25
ISBT 128	54h	Enable	10-25
ISBT Concatenation	F1h 41h	Disable	10-26
Check ISBT Table	F1h 42h	Enable	10-27
ISBT Concatenation Redundancy	DFh	10	10-27
Code 39			
Code 39	00h	Enable	10-28
Trioptic Code 39	0Dh	Disable	10-28
Convert Code 39 to Code 32 (Italian Pharmacy Code)	56h	Disable	10-29
Code 32 Prefix	E7h	Disable	10-29
Set Length(s) for Code 39	12h 13h	2 to 55	10-30
Code 39 Check Digit Verification	30h	Disable	10-31
Transmit Code 39 Check Digit	2Bh	Disable	10-32
Code 39 Full ASCII Conversion	11h	Disable	10-32
Buffer Code 39	71h	Disable	10-33
Code 93			
Code 93	09h	Disable	10-36
Set Length(s) for Code 93	1Ah 1Bh	4 to 55	10-36
Code 11			
Code 11	0Ah	Disable	10-38
Set Lengths for Code 11	1Ch 1Dh	4 to 55	10-38
Code 11 Check Digit Verification	34h	Disable	10-40
Transmit Code 11 Check Digit(s)	2Fh	Disable	10-41

¹User selection is required to configure this interface and this is the most common selection.

Table A-1 Standard Default Parameters Table (Continued)

Parameter	Parameter Number	Default	Page Number
Interleaved 2 of 5 (ITF)			
Interleaved 2 of 5 (ITF)	06h	Enable	10-42
Set Lengths for I 2 of 5	16h 17h	14	10-42
I 2 of 5 Check Digit Verification	31h	Disable	10-44
Transmit I 2 of 5 Check Digit	2Ch	Disable	10-44
Convert I 2 of 5 to EAN 13	52h	Disable	10-45
Discrete 2 of 5 (DTF)			
Discrete 2 of 5	05h	Disable	10-46
Set Length(s) for D 2 of 5	14h 15h	12	10-46
Codabar (NW - 7)			
Codabar	07h	Disable	10-48
Set Lengths for Codabar	18h 19h	5 to 55	10-48
CLSI Editing	36h	Disable	10-50
NOTIS Editing	37h	Disable	10-50
MSI			
MSI	0Bh	Disable	10-51
Set Length(s) for MSI	1Eh 1Fh	4 to 55	10-51
MSI Check Digits	32h	One	10-52
Transmit MSI Check Digit	2Eh	Disable	10-53
MSI Check Digit Algorithm	33h	Mod 10/Mod 10	10-53
Chinese 2 of 5			
Chinese 2 of 5	F0h 98h	Disable	10-54
Matrix 2 of 5			
Matrix 2 of 5	F1h 6Ah	Disable	10-55
Matrix 2 of 5 Lengths	F1h 6Bh F1h 6Ch	1 Length - 14	10-56
Matrix 2 of 5 Redundancy	F1h 6Dh	Disable	10-57
Matrix 2 of 5 Check Digit	F1h 6Eh	Disable	10-57

¹User selection is required to configure this interface and this is the most common selection.

Table A-1 Standard Default Parameters Table (Continued)

Parameter	Parameter Number	Default	Page Number
Transmit Matrix 2 of 5 Check Digit	F1h 6Fh	Disable	10-58
Inverse 1D Decoder	F1h 4Ah	SR, DC: Regular DP, HD: Autodetect	10-59
Postal Codes			
US Postnet	59h	Enable	10-60
US Planet	5Ah	Enable	10-60
Transmit US Postal Check Digit	5Fh	Enable	10-61
UK Postal	5Bh	Enable	10-61
Transmit UK Postal Check Digit	60h	Enable	10-62
Japan Postal	F0h 22h	Enable	10-62
Australian Postal	F0h 23h	Enable	10-63
Netherlands KIX Code	F0h 46h	Enable	10-63
USPS 4CB/One Code/Intelligent Mail	F1h 50h	Disable	10-64
UPU FICS Postal	F1h 63h	Disable	10-64
GS1 DataBar			
GS1 DataBar-14	F0h 52h	Enable	10-65
GS1 DataBar Limited	F0h 53h	Enable	10-65
GS1 DataBar Expanded	F0h 54h	Enable	10-66
Convert GS1 DataBar to UPC/EAN	F0h 8Dh	Disable	10-66
Composite			
Composite CC-C	F0h 55h	Disable	10-67
Composite CC-A/B	F0h 56h	Disable	10-67
Composite TLC-39	F0h 73h	Disable	10-68
UPC Composite Mode	F0h 58h	Always Linked	10-69
Composite Beep Mode	F0h 8Eh	Beep As Each Code Type is Decoded	10-70
GS1-128 Emulation Mode for UCC/EAN Composite Codes	F0h ABh	Disable	10-70

¹User selection is required to configure this interface and this is the most common selection.

Table A-1 Standard Default Parameters Table (Continued)

Parameter	Parameter Number	Default	Page Number
2D Symbologies			
PDF417	0Fh	Enable	10-71
MicroPDF417	E3h	Disable	10-71
Code 128 Emulation	7Bh	Disable	10-72
Data Matrix	F0h 24h	Enable	10-73
Data Matrix Inverse	F1h 4Ch	SR, DC: Regular DP, HD: Autodetect	10-74
Maxicode	F0h 26h	Enable	10-75
QR Code	F0h 25h	Enable	10-75
QR Inverse	F1h 4Bh	SR, DC: Regular DP, HD: Autodetect	10-76
MicroQR	F1h 3Dh	Enable	10-77
Aztec	F1h 3Eh	Enable	10-77
Aztec Inverse	F1h 4Dh	SR, DC: Regular DP, HD: Autodetect	10-78
Symbology-Specific Security Levels			
Redundancy Level	4Eh	1	10-79
Security Level	4Dh	1	10-81
Intercharacter Gap Size	F0h 7Dh	Normal	10-82
Report Version			10-82
Macro PDF			
Flush Macro PDF Buffer			10-83
Abort Macro PDF Entry			10-83

¹User selection is required to configure this interface and this is the most common selection.

Appendix B Programming Reference

Symbol Code Identifiers

Table B-1 *Symbol Code Characters*

Code Character	Code Type
A	UPC-A, UPC-E, UPC-E1, EAN-8, EAN-13
B	Code 39, Code 32
C	Codabar
D	Code 128, ISBT 128, ISBT 128 Concatenated
E	Code 93
F	Interleaved 2 of 5
G	Discrete 2 of 5, or Discrete 2 of 5 IATA
H	Code 11
J	MSI
K	GS1-128
L	Bookland EAN
M	Trioptic Code 39
N	Coupon Code
R	GS1 DataBar Family
S	Matrix 2 of 5
T	UCC Composite, TLC 39
U	Chinese 2 of 5

Table B-1 *Symbol Code Characters (Continued)*

Code Character	Code Type
X	ISSN EAN, PDF417, Macro PDF417, Micro PDF417
z	Aztec, Aztec Rune
P00	Data Matrix
P01	QR Code, MicroQR
P02	Maxicode
P03	US Postnet
P04	US Planet
P05	Japan Postal
P06	UK Postal
P08	Netherlands KIX Code
P09	Australian Postal
P0A	USPS 4CB/One Code/Intelligent Mail
P0B	UPU FICS Postal
P0X	Signature Capture

AIM Code Identifiers

Each AIM Code Identifier contains the three-character string **Jcm** where:

- J = Flag Character (ASCII 93)
- c = Code Character (see [Table B-2](#))
- m = Modifier Character (see [Table B-3](#))

Table B-2 *Aim Code Characters*

Code Character	Code Type
A	Code 39, Code 39 Full ASCII, Code 32
C	Code 128, ISBT 128, ISBT 128 Concatenated, GS1-128, Coupon (Code 128 portion)
d	Data Matrix
E	UPC/EAN, Coupon (UPC portion)
e	GS1 DataBar Family
F	Codabar
G	Code 93
H	Code 11
I	Interleaved 2 of 5
L	PDF417, Macro PDF417, Micro PDF417
L2	TLC 39
M	MSI
Q	QR Code, MicroQR
S	Discrete 2 of 5, IATA 2 of 5
U	Maxicode
z	Aztec, Aztec Rune
X	Bookland EAN, ISSN EAN, Trioptic Code 39, Chinese 2 of 5, Matrix 2 of 5, US Postnet, US Planet, UK Postal, Japan Postal, Australian Postal, Netherlands KIX Code, USPS 4CB/One Code/Intelligent Mail, UPU FICS Postal, Signature Capture

The modifier character is the sum of the applicable option values based on [Table B-3](#).

Table B-3 *Modifier Characters*

Code Type	Option Value	Option
Code 39	0	No check character or Full ASCII processing.
	1	Reader has checked one check character.
	3	Reader has checked and stripped check character.
	4	Reader has performed Full ASCII character conversion.
	5	Reader has performed Full ASCII character conversion and checked one check character.
	7	Reader has performed Full ASCII character conversion and checked and stripped check character.
Example: A Full ASCII bar code with check character W, A+I+MI+DW , is transmitted as J A7AIMID where 7 = (3+4).		
Trioptic Code 39	0	No option specified at this time. Always transmit 0.
	Example: A Trioptic bar code 412356 is transmitted as J X0412356	
Code 128	0	Standard data packet, no Function code 1 in first symbol position.
	1	Function code 1 in first symbol character position.
	2	Function code 1 in second symbol character position.
Example: A Code (EAN) 128 bar code with Function 1 character ^{FNC1} in the first position, AIMID is transmitted as J C1AIMID		
I 2 of 5	0	No check digit processing.
	1	Reader has validated check digit.
	3	Reader has validated and stripped check digit.
Example: An I 2 of 5 bar code without check digit, 4123, is transmitted as J I04123		
Codabar	0	No check digit processing.
	1	Reader has checked check digit.
	3	Reader has stripped check digit before transmission.
Example: A Codabar bar code without check digit, 4123, is transmitted as J F04123		
Code 93	0	No options specified at this time. Always transmit 0.
	Example: A Code 93 bar code 012345678905 is transmitted as J G0012345678905	
MSI	0	Check digits are sent.
	1	No check digit is sent.
Example: An MSI bar code 4123, with a single check digit checked, is transmitted as J M14123		

Table B-3 *Modifier Characters (Continued)*

Code Type	Option Value	Option
D 2 of 5	0	No options specified at this time. Always transmit 0.
		Example: A D 2 of 5 bar code 4123, is transmitted as JS04123
UPC/EAN	0	Standard packet in full EAN country code format, which is 13 digits for UPC-A, UPC-E, and EAN-13 (not including supplemental data).
	1	Two-digit supplement data only.
	2	Five-digit supplement data only.
	3	Combined data packet comprising 13 digits from a UPC-A, UPC-E, or EAN-13 symbol and 2 or 5 digits from a supplemental symbol.
	4	EAN-8 data packet.
		Example: A UPC-A bar code 012345678905 is transmitted as JE00012345678905
Bookland EAN	0	No options specified at this time. Always transmit 0.
		Example: A Bookland EAN bar code 123456789X is transmitted as JX0123456789X
ISSN EAN	0	No options specified at this time. Always transmit 0.
		Example: An ISSN EAN bar code 123456789X is transmitted as JX0123456789X
Code 11	0	Single check digit
	1	Two check digits
	3	Check characters validated but not transmitted.
GS1 DataBar Family		No option specified at this time. Always transmit 0. DataBar-14 and DataBar Limited transmit with an Application Identifier "01". Note: In GS1-128 emulation mode, GS1 DataBar is transmitted using Code 128 rules (i.e., JC1).
		Example: A DataBar-14 bar code 0110012345678902 is transmitted as Je00110012345678902 .
EAN.UCC Composites (GS1 DataBar, GS1-128, 2D portion of UPC composite)		Native mode transmission. Note: UPC portion of composite is transmitted using UPC rules.
	0	Standard data packet.
	1	Data packet containing the data following an encoded symbol separator character.
	2	Data packet containing the data following an escape mechanism character. The data packet does not support the ECI protocol.
	3	Data packet containing the data following an escape mechanism character. The data packet supports the ECI protocol.
		GS1-128 emulation Note: UPC portion of composite is transmitted using UPC rules.
	1	Data packet is a GS1-128 symbol (i.e., data is preceded with JC1).

Table B-3 Modifier Characters (Continued)

Code Type	Option Value	Option
PDF417, Micro PDF417	0	Reader set to conform to protocol defined in 1994 PDF417 symbology specifications. Note: When this option is transmitted, the receiver cannot reliably determine whether ECIs have been invoked or whether data byte 92 _{DEC} has been doubled in transmission.
	1	Reader set to follow the ECI protocol (Extended Channel Interpretation). All data characters 92 _{DEC} are doubled.
	2	Reader set for Basic Channel operation (no escape character transmission protocol). Data characters 92 _{DEC} are not doubled. Note: When decoders are set to this mode, unbuffered Macro symbols and symbols requiring the decoder to convey ECI escape sequences cannot be transmitted.
	3	The bar code contains a GS1-128 symbol, and the first codeword is 903-907, 912, 914, 915.
	4	The bar code contains a GS1-128 symbol, and the first codeword is in the range 908-909.
	5	The bar code contains a GS1-128 symbol, and the first codeword is in the range 910-911.
	Example: A PDF417 bar code ABCD, with no transmission protocol enabled, is transmitted as]L2ABCD.	
Data Matrix	0	ECC 000-140, not supported.
	1	ECC 200.
	2	ECC 200, FNC1 in first or fifth position.
	3	ECC 200, FNC1 in second or sixth position.
	4	ECC 200, ECI protocol implemented.
	5	ECC 200, FNC1 in first or fifth position, ECI protocol implemented.
	6	ECC 200, FNC1 in second or sixth position, ECI protocol implemented.
MaxiCode	0	Symbol in Mode 4 or 5.
	1	Symbol in Mode 2 or 3.
	2	Symbol in Mode 4 or 5, ECI protocol implemented.
	3	Symbol in Mode 2 or 3, ECI protocol implemented in secondary message.

Table B-3 *Modifier Characters (Continued)*

Code Type	Option Value	Option
QR Code	0	Model 1 symbol.
	1	Model 2 / MicroQR symbol, ECI protocol not implemented.
	2	Model 2 symbol, ECI protocol implemented.
	3	Model 2 symbol, ECI protocol not implemented, FNC1 implied in first position.
	4	Model 2 symbol, ECI protocol implemented, FNC1 implied in first position.
	5	Model 2 symbol, ECI protocol not implemented, FNC1 implied in second position.
	6	Model 2 symbol, ECI protocol implemented, FNC1 implied in second position.
Aztec	0	Aztec symbol.
	C	Aztec Rune symbol.

Appendix C Sample Bar Codes

Code 39



UPC/EAN

UPC-A, 100%



EAN-13, 100%



Code 128



Interleaved 2 of 5



GS1 DataBar-14

✓ **NOTE** GS1 DataBar-14 must be enabled to read the bar code below (see [GS1 DataBar-14 on page 10-65](#)).



7612341562341

PDF417



Data Matrix



Maxicode

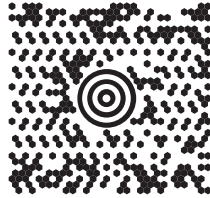

QR Code



US Postnet



UK Postal



Appendix D Numeric Bar Codes

Numeric Bar Codes

For parameters requiring specific numeric values, scan the appropriately numbered bar code(s).



Numeric Bar Codes (continued)



5



6



7



8



9

Cancel

To correct an error or change a selection, scan the bar code below.



Cancel

Appendix E ASCII Character Sets

Table E-1 *ASCII Value Table*

ASCII Value	Full ASCII Code 39 Encode Char	Keystroke
1000	%U	CTRL 2
1001	\$A	CTRL A
1002	\$B	CTRL B
1003	\$C	CTRL C
1004	\$D	CTRL D
1005	\$E	CTRL E
1006	\$F	CTRL F
1007	\$G	CTRL G
1008	\$H	CTRL H/ BACKSPACE ¹
1009	\$I	CTRL I/ HORIZONTAL TAB ¹
1010	\$J	CTRL J
1011	\$K	CTRL K
1012	\$L	CTRL L
1013	\$M	CTRL M/ ENTER ¹
1014	\$N	CTRL N
1015	\$O	CTRL O

The keystroke in bold transmits only if Function Key Mapping is enabled. Otherwise, the unbold keystroke transmits.

Table E-1 ASCII Value Table (Continued)

ASCII Value	Full ASCII Code 39 Encode Char	Keystroke
1016	\$P	CTRL P
1017	\$Q	CTRL Q
1018	\$R	CTRL R
1019	\$S	CTRL S
1020	\$T	CTRL T
1021	\$U	CTRL U
1022	\$V	CTRL V
1023	\$W	CTRL W
1024	\$X	CTRL X
1025	\$Y	CTRL Y
1026	\$Z	CTRL Z
1027	%A	CTRL [
1028	%B	CTRL \
1029	%C	CTRL]
1030	%D	CTRL 6
1031	%E	CTRL -
1032	Space	Space
1033	/A	!
1034	/B	"
1035	/C	#
1036	/D	\$
1037	/E	%
1038	/F	&
1039	/G	'
1040	/H	(
1041	/I)
1042	/J	*
1043	/K	+

The keystroke in bold transmits only if Function Key Mapping is enabled. Otherwise, the unbold keystroke transmits.

Table E-1 ASCII Value Table (Continued)

ASCII Value	Full ASCII Code 39 Encode Char	Keystroke
1044	/L	,
1045	-	-
1046	.	.
1047	/o	/
1048	0	0
1049	1	1
1050	2	2
1051	3	3
1052	4	4
1053	5	5
1054	6	6
1055	7	7
1056	8	8
1057	9	9
1058	/Z	:
1059	%F	;
1060	%G	<
1061	%H	=
1062	%I	>
1063	%J	?
1064	%V	@
1065	A	A
1066	B	B
1067	C	C
1068	D	D
1069	E	E
1070	F	F
1071	G	G

The keystroke in bold transmits only if Function Key Mapping is enabled. Otherwise, the unbold keystroke transmits.

Table E-1 ASCII Value Table (Continued)

ASCII Value	Full ASCII Code 39 Encode Char	Keystroke
1072	H	H
1073	I	I
1074	J	J
1075	K	K
1076	L	L
1077	M	M
1078	N	N
1079	O	O
1080	P	P
1081	Q	Q
1082	R	R
1083	S	S
1084	T	T
1085	U	U
1086	V	V
1087	W	W
1088	X	X
1089	Y	Y
1090	Z	Z
1091	%K	[
1092	%L	\
1093	%M]
1094	%N	^
1095	%O	_
1096	%W	'
1097	+A	a
1098	+B	b
1099	+C	c

The keystroke in bold transmits only if Function Key Mapping is enabled. Otherwise, the unbold keystroke transmits.

Table E-1 ASCII Value Table (Continued)

ASCII Value	Full ASCII Code 39 Encode Char	Keystroke
1100	+D	d
1101	+E	e
1102	+F	f
1103	+G	g
1104	+H	h
1105	+I	i
1106	+J	j
1107	+K	k
1108	+L	l
1109	+M	m
1110	+N	n
1111	+O	o
1112	+P	p
1113	+Q	q
1114	+R	r
1115	+S	s
1116	+T	t
1117	+U	u
1118	+V	v
1119	+W	w
1120	+X	x
1121	+Y	y
1122	+Z	z
1123	%P	{
1124	%Q	
1125	%R	}
1126	%S	~

The keystroke in bold transmits only if Function Key Mapping is enabled. Otherwise, the unbold keystroke transmits.

Table E-2 *ALT Key Standard Default Tables*

ALT Keys	Keystroke
2064	ALT 2
2065	ALT A
2066	ALT B
2067	ALT C
2068	ALT D
2069	ALT E
2070	ALT F
2071	ALT G
2072	ALT H
2073	ALT I
2074	ALT J
2075	ALT K
2076	ALT L
2077	ALT M
2078	ALT N
2079	ALT O
2080	ALT P
2081	ALT Q
2082	ALT R
2083	ALT S
2084	ALT T
2085	ALT U
2086	ALT V
2087	ALT W
2088	ALT X
2089	ALT Y
2090	ALT Z

Table E-3 *USB GUI Key Character Set*

GUI Key	Keystroke
3000	Right Control Key
3048	GUI 0
3049	GUI 1
3050	GUI 2
3051	GUI 3
3052	GUI 4
3053	GUI 5
3054	GUI 6
3055	GUI 7
3056	GUI 8
3057	GUI 9
3065	GUI A
3066	GUI B
3067	GUI C
3068	GUI D
3069	GUI E
3070	GUI F
3071	GUI G
3072	GUI H
3073	GUI I
3074	GUI J
3075	GUI K
3076	GUI L
3077	GUI M
3078	GUI N
3079	GUI O

Note: GUI Shift Keys - The Apple™ iMac keyboard has an apple key on either side of the space bar. Windows-based systems have a GUI key to the left of the left ALT key, and to the right of the right ALT key.

Table E-3 USB GUI Key Character Set (Continued)

GUI Key	Keystroke
3080	GUI P
3081	GUI Q
3082	GUI R
3083	GUI S
3084	GUI T
3085	GUI U
3086	GUI V
3087	GUI W
3088	GUI X
3089	GUI Y
3090	GUI Z

Note: GUI Shift Keys - The Apple™ iMac keyboard has an apple key on either side of the space bar. Windows-based systems have a GUI key to the left of the left ALT key, and to the right of the right ALT key.

Table E-4 *PF Key Standard Default Table*

PF Keys	Keystroke
4001	PF 1
4002	PF 2
4003	PF 3
4004	PF 4
4005	PF 5
4006	PF 6
4007	PF 7
4008	PF 8
4009	PF 9
4010	PF 10
4011	PF 11
4012	PF 12
4013	PF 13
4014	PF 14
4015	PF 15
4016	PF 16

Table E-5 *F key Standard Default Table*

F Keys	Keystroke
5001	F 1
5002	F 2
5003	F 3
5004	F 4
5005	F 5
5006	F 6
5007	F 7
5008	F 8
5009	F 9
5010	F 10
5011	F 11
5012	F 12
5013	F 13
5014	F 14
5015	F 15
5016	F 16
5017	F 17
5018	F 18
5019	F 19
5020	F 20
5021	F 21
5022	F 22
5023	F 23
5024	F 24

Table E-6 *Numeric Key Standard Default Table*

Numeric Keypad	Keystroke
6042	*
6043	+
6044	Undefined
6045	-
6046	.
6047	/
6048	0
6049	1
6050	2
6051	3
6052	4
6053	5
6054	6
6055	7
6056	8
6057	9
6058	Enter
6059	Num Lock

Table E-7 *Extended Keypad Standard Default Table*

Extended Keypad	Keystroke
7001	Break
7002	Delete
7003	Pg Up
7004	End
7005	Pg Dn
7006	Pause
7007	Scroll Lock
7008	Backspace
7009	Tab
7010	Print Screen
7011	Insert
7012	Home
7013	Enter
7014	Escape
7015	Up Arrow
7016	Dn Arrow
7017	Left Arrow
7018	Right Arrow

Glossary

A

Aperture. The opening in an optical system defined by a lens or baffle that establishes the field of view.

API. An interface by means of which one software component communicates with or controls another. Usually used to refer to services provided by one software component to another, usually via software interrupts or function calls

Application Programming Interface. See **API**.

ASCII. American Standard Code for Information Interchange. A 7 bit-plus-parity code representing 128 letters, numerals, punctuation marks and control characters. It is a standard data transmission code in the U.S.

Autodiscrimination. The ability of an interface controller to determine the code type of a scanned bar code. After this determination is made, the information content is decoded.

B

Bar. The dark element in a printed bar code symbol.

Bar Code. A pattern of variable-width bars and spaces which represents numeric or alphanumeric data in machine-readable form. The general format of a bar code symbol consists of a leading margin, start character, data or message character, check character (if any), stop character, and trailing margin. Within this framework, each recognizable symbology uses its own unique format. See **Symbology**.

Bar Code Density. The number of characters represented per unit of measurement (e.g., characters per inch).

Bar Height. The dimension of a bar measured perpendicular to the bar width.

Bar Width. Thickness of a bar measured from the edge closest to the symbol start character to the trailing edge of the same bar.

BIOS. Basic Input Output System. A collection of ROM-based code with a standard API used to interface with standard PC hardware.

Bit. Binary digit. One bit is the basic unit of binary information. Generally, eight consecutive bits compose one byte of data. The pattern of 0 and 1 values within the byte determines its meaning.

Bits per Second (bps). Bits transmitted or received.

Boot or Boot-up. The process a computer goes through when it starts. During boot-up, the computer can run self-diagnostic tests and configure hardware and software.

BOOTP. A protocol for remote booting of diskless devices. Assigns an IP address to a machine and may specify a boot file. The client sends a bootp request as a broadcast to the bootp server port (67) and the bootp server responds using the bootp client port (68). The bootp server must have a table of all devices, associated MAC addresses and IP addresses.

bps. See **Bits Per Second**.

Byte. On an addressable boundary, eight adjacent binary digits (0 and 1) combined in a pattern to represent a specific character or numeric value. Bits are numbered from the right, 0 through 7, with bit 0 the low-order bit. One byte in memory is used to store one ASCII character.

C

CDRH. Center for Devices and Radiological Health. A federal agency responsible for regulating laser product safety. This agency specifies various laser operation classes based on power output during operation.

CDRH Class 1. This is the lowest power CDRH laser classification. This class is considered intrinsically safe, even if all laser output were directed into the eye's pupil. There are no special operating procedures for this class.

CDRH Class 2. No additional software mechanisms are needed to conform to this limit. Laser operation in this class poses no danger for unintentional direct human exposure.

Character. A pattern of bars and spaces which either directly represents data or indicates a control function, such as a number, letter, punctuation mark, or communications control contained in a message.

Character Set. Those characters available for encoding in a particular bar code symbology.

Check Digit. A digit used to verify a correct symbol decode. The scanner inserts the decoded data into an arithmetic formula and checks that the resulting number matches the encoded check digit. Check digits are required for UPC but are optional for other symbologies. Using check digits decreases the chance of substitution errors when a symbol is decoded.

Codabar. A discrete self-checking code with a character set consisting of digits 0 to 9 and six additional characters: (- \$: / , +).

Code 128. A high density symbology which allows the controller to encode all 128 ASCII characters without adding extra symbol elements.

Code 3 of 9 (Code 39). A versatile and widely used alphanumeric bar code symbology with a set of 43 character types, including all uppercase letters, numerals from 0 to 9 and 7 special characters (- . / + % \$ and space). The code name is derived from the fact that 3 of 9 elements representing a character are wide, while the remaining 6 are narrow.

Code 93. An industrial symbology compatible with Code 39 but offering a full character ASCII set and a higher coding density than Code 39.

Code Length. Number of data characters in a bar code between the start and stop characters, not including those characters.

Cold Boot. A cold boot restarts the mobile computer and erases all user stored records and entries.

COM Port. Communication port; ports are identified by number, e.g., COM1, COM2.

Continuous Code. A bar code or symbol in which all spaces within the symbol are parts of characters. There are no intercharacter gaps in a continuous code. The absence of gaps allows for greater information density.

Cradle. A cradle is used for charging the terminal battery and for communicating with a host computer, and provides a storage place for the terminal when not in use.

D

Dead Zone. An area within a scanner's field of view, in which specular reflection may prevent a successful decode.

Decode. To recognize a bar code symbology (e.g., UPC/EAN) and then analyze the content of the specific bar code scanned.

Decode Algorithm. A decoding scheme that converts pulse widths into data representation of the letters or numbers encoded within a bar code symbol.

Decryption. Decryption is the decoding and unscrambling of received encrypted data. Also see, **Encryption** and **Key**.

Depth of Field. The range between minimum and maximum distances at which a scanner can read a symbol with a certain minimum element width.

Discrete 2 of 5. A binary bar code symbology representing each character by a group of five bars, two of which are wide. The location of wide bars in the group determines which character is encoded; spaces are insignificant. Only numeric characters (0 to 9) and START/STOP characters may be encoded.

Discrete Code. A bar code or symbol in which the spaces between characters (intercharacter gaps) are not part of the code.

DRAM. Dynamic random access memory.

E

EAN. European Article Number. This European/International version of the UPC provides its own coding format and symbology standards. Element dimensions are specified metrically. EAN is used primarily in retail.

Element. Generic term for a bar or space.

Encoded Area. Total linear dimension occupied by all characters of a code pattern, including start/stop characters and data.

ENQ (RS-232). ENQ software handshaking is also supported for the data sent to the host.

ESD. Electro-Static Discharge

F

Flash Disk. An additional megabyte of non-volatile memory for storing application and configuration files.

Flash Memory. Flash memory is responsible for storing the system firmware and is non-volatile. If the system power is interrupted the data is not be lost.

FTP. See **File Transfer Protocol**.

H

Hard Reset. See **Cold Boot**.

Host Computer. A computer that serves other terminals in a network, providing such services as computation, database access, supervisory programs and network control.

Hz. Hertz; A unit of frequency equal to one cycle per second.

I

IDE. Intelligent drive electronics. Refers to the solid-state hard drive type.

IEC. International Electrotechnical Commission. This international agency regulates laser safety by specifying various laser operation classes based on power output during operation.

IEC (825) Class 1. This is the lowest power IEC laser classification. Conformity is ensured through a software restriction of 120 seconds of laser operation within any 1000 second window and an automatic laser shutdown if the scanner's oscillating mirror fails.

Input/Output Ports. I/O ports are primarily dedicated to passing information into or out of the device's memory, such as serial and USB ports.

Intercharacter Gap. The space between two adjacent bar code characters in a discrete code.

Interleaved 2 of 5. A binary bar code symbology representing character pairs in groups of five bars and five interleaved spaces. Interleaving provides for greater information density. The location of wide elements (bar/spaces) within each group determines which characters are encoded. This continuous code type uses no intercharacter spaces. Only numeric (0 to 9) and START/STOP characters may be encoded.

Interleaved Bar Code. A bar code in which characters are paired together, using bars to represent the first character and the intervening spaces to represent the second.

I/O Ports. interface The connection between two devices, defined by common physical characteristics, signal characteristics, and signal meanings. Types of interfaces include RS-232 and PCMCIA.

IOCTL. Input/Output Control.

IP. Internet Protocol. The IP part of the TCP/IP communications protocol. IP implements the network layer (layer 3) of the protocol, which contains a network address and is used to route a message to a different network or subnetwork. IP accepts “packets” from the layer 4 transport protocol (TCP or UDP), adds its own header to it and delivers a “datagram” to the layer 2 data link protocol. It may also break the packet into fragments to support the maximum transmission unit (MTU) of the network.

IP Address. (Internet Protocol address) The address of a computer attached to an IP network. Every client and server station must have a unique IP address. A 32-bit address used by a computer on a IP network. Client workstations have either a permanent address or one that is dynamically assigned to them each session. IP addresses are written as four sets of numbers separated by periods; for example, 204.171.64.2.

IPX/SPX. Internet Package Exchange/Sequential Packet Exchange. A communications protocol for Novell. IPX is Novell's Layer 3 protocol, similar to XNS and IP, and used in NetWare networks. SPX is Novell's version of the Xerox SPP protocol.

K

Key. A key is the specific code used by the algorithm to encrypt or decrypt the data. Also see, **Encryption** and **Decrypting**.

L

LASER. Light Amplification by Stimulated Emission of Radiation. The laser is an intense light source. Light from a laser is all the same frequency, unlike the output of an incandescent bulb. Laser light is typically coherent and has a high energy density.

Laser Diode. A gallium-arsenide semiconductor type of laser connected to a power source to generate a laser beam. This laser type is a compact source of coherent light.

Laser Scanner. A type of bar code reader that uses a beam of laser light.

LCD. See **Liquid Crystal Display**.

LED Indicator. A semiconductor diode (LED - Light Emitting Diode) used as an indicator, often in digital displays. The semiconductor uses applied voltage to produce light of a certain frequency determined by the semiconductor's particular chemical composition.

Light Emitting Diode. See **LED**.

Liquid Crystal Display (LCD). A display that uses liquid crystal sealed between two glass plates. The crystals are excited by precise electrical charges, causing them to reflect light outside according to their bias. They use little electricity and react relatively quickly. They require external light to reflect their information to the user.

M

MDN. Mobile Directory Number. The directory listing telephone number that is dialed (generally using POTS) to reach a mobile unit. The MDN is usually associated with a MIN in a cellular telephone -- in the US and Canada, the MDN and

MIN are the same value for voice cellular users. International roaming considerations often result in the MDN being different from the MIN.

MIL. 1 mil = 1 thousandth of an inch.

MIN. Mobile Identification Number. The unique account number associated with a cellular device. It is broadcast by the cellular device when accessing the cellular system.

Misread (Misdecode). A condition which occurs when the data output of a reader or interface controller does not agree with the data encoded within a bar code symbol.

N

Nominal. The exact (or ideal) intended value for a specified parameter. Tolerances are specified as positive and negative deviations from this value.

Nominal Size. Standard size for a bar code symbol. Most UPC/EAN codes are used over a range of magnifications (e.g., from 0.80 to 2.00 of nominal).

NVM. Non-Volatile Memory.

O

ODI. See **Open Data-Link Interface**.

Open Data-Link Interface (ODI). Novell's driver specification for an interface between network hardware and higher-level protocols. It supports multiple protocols on a single NIC (Network Interface Controller). It is capable of understanding and translating any network information or request sent by any other ODI-compatible protocol into something a NetWare client can understand and process.

Open System Authentication. Open System authentication is a null authentication algorithm.

P

PAN . Personal area network. Using Bluetooth wireless technology, PANs enable devices to communicate wirelessly. Generally, a wireless PAN consists of a dynamic group of less than 255 devices that communicate within about a 33-foot range. Only devices within this limited area typically participate in the network.

Parameter. A variable that can have different values assigned to it.

PC Card. A plug-in expansion card for laptop computers and other devices, also called a PCMCIA card. PC Cards are 85.6mm long x 54 mm wide, and have a 68 pin connector. There are several different kinds:

- Type I; 3.3 mm high; use - RAM or Flash RAM
- Type II; 5 mm high; use - modems, LAN adaptors
- Type III; 10.5 high; use - Hard Disks

PCMCIA. Personal Computer Memory Card Interface Association. See **PC Card**.

Percent Decode. The average probability that a single scan of a bar code would result in a successful decode. In a well-designed bar code scanning system, that probability should approach near 100%.

PING. (Packet Internet Groper) An Internet utility used to determine whether a particular IP address is online. It is used to test and debug a network by sending out a packet and waiting for a response.

Print Contrast Signal (PCS). Measurement of the contrast (brightness difference) between the bars and spaces of a symbol. A minimum PCS value is needed for a bar code symbol to be scannable. $PCS = (RL - RD) / RL$, where RL is the reflectance factor of the background and RD the reflectance factor of the dark bars.

Programming Mode. The state in which a scanner is configured for parameter values. See **Scanning Mode**.

Q

Quiet Zone. A clear space, containing no dark marks, which precedes the start character of a bar code symbol and follows the stop character.

QWERTY. A standard keyboard commonly used on North American and some European PC keyboards. "QWERTY" refers to the arrangement of keys on the left side of the third row of keys.

R

RAM. Random Access Memory. Data in RAM can be accessed in random order, and quickly written and read.

Reflectance. Amount of light returned from an illuminated surface.

Resolution. The narrowest element dimension which is distinguished by a particular reading device or printed with a particular device or method.

RF. Radio Frequency.

ROM. Read-Only Memory. Data stored in ROM cannot be changed or removed.

Router. A device that connects networks and supports the required protocols for packet filtering. Routers are typically used to extend the range of cabling and to organize the topology of a network into subnets. See **Subnet**.

RS-232. An Electronic Industries Association (EIA) standard that defines the connector, connector pins, and signals used to transfer data serially from one device to another.

S

Scan Area. Area intended to contain a symbol.

Scanner. An electronic device used to scan bar code symbols and produce a digitized pattern that corresponds to the bars and spaces of the symbol. Its three main components are: 1) Light source (laser or photoelectric cell) - illuminates a bar code;; 2) Photodetector - registers the difference in reflected light (more light reflected from spaces); 3) Signal conditioning circuit - transforms optical detector output into a digitized bar pattern.

Scanning Mode. The scanner is energized, programmed and ready to read a bar code.

Scanning Sequence. A method of programming or configuring parameters for a bar code reading system by scanning bar code menus.

SDK. Software Development Kit

Self-Checking Code. A symbology that uses a checking algorithm to detect encoding errors within the characters of a bar code symbol.

Shared Key. Shared Key authentication is an algorithm where both the AP and the MU share an authentication key.

SHIP. Symbol Host Interface Program.

SID. System Identification code. An identifier issued by the FCC for each market. It is also broadcast by the cellular carriers to allow cellular devices to distinguish between the home and roaming service.

Soft Reset. See **Warm Boot.**

Space. The lighter element of a bar code formed by the background between bars.

Specular Reflection. The mirror-like direct reflection of light from a surface, which can cause difficulty decoding a bar code.

Start/Stop Character. A pattern of bars and spaces that provides the scanner with start and stop reading instructions and scanning direction. The start and stop characters are normally to the left and right margins of a horizontal code.

STEP. Symbol Terminal Enabler Program.

Subnet. A subset of nodes on a network that are serviced by the same router. See **Router.**

Subnet Mask. A 32-bit number used to separate the network and host sections of an IP address. A custom subnet mask subdivides an IP network into smaller subsections. The mask is a binary pattern that is matched up with the IP address to turn part of the host ID address field into a field for subnets. Default is often 255.255.255.0.

Substrate. A foundation material on which a substance or image is placed.

SVTP. Symbol Virtual Terminal Program.

Symbol. A scannable unit that encodes data within the conventions of a certain symbology, usually including start/stop characters, quiet zones, data characters and check characters.

Symbol Aspect Ratio. The ratio of symbol height to symbol width.

Symbol Height. The distance between the outside edges of the quiet zones of the first row and the last row.

Symbol Length. Length of symbol measured from the beginning of the quiet zone (margin) adjacent to the start character to the end of the quiet zone (margin) adjacent to a stop character.

Symbology. The structural rules and conventions for representing data within a particular bar code type (e.g. UPC/EAN, Code 39, PDF417, etc.).

T

TCP/IP. (Transmission Control Protocol/Internet Protocol) A communications protocol used to internetwork dissimilar systems. This standard is the protocol of the Internet and has become the global standard for communications. TCP provides transport functions, which ensures that the total amount of bytes sent is received correctly at the other end. UDP is an alternate transport that does not guarantee delivery. It is widely used for real-time voice and video transmissions where erroneous packets are not retransmitted. IP provides the routing mechanism. TCP/IP is a routable protocol, which means that all messages contain not only the address of the destination station, but the address of a destination network. This allows TCP/IP messages to be sent to multiple networks within an organization or around the world, hence its use in the worldwide Internet. Every client and server in a TCP/IP network requires an IP address, which is either permanently assigned or dynamically assigned at startup.

Telnet. A terminal emulation protocol commonly used on the Internet and TCP/IP-based networks. It allows a user at a terminal or computer to log onto a remote device and run a program.

Terminal Emulation. A “terminal emulation” emulates a character-based mainframe session on a remote non-mainframe terminal, including all display features, commands and function keys. The VC5000 Series supports Terminal Emulations in 3270, 5250 and VT220.

Terminate and Stay Resident (TSR). A program under DOS that ends its foreground execution to remain resident in memory to service hardware/software interrupts, providing background operation. It remains in memory and may provide services on behalf of other DOS programs.

TFTP. (Trivial File Transfer Protocol) A version of the TCP/IP FTP (File Transfer Protocol) protocol that has no directory or password capability. It is the protocol used for upgrading firmware, downloading software and remote booting of diskless devices.

Tolerance. Allowable deviation from the nominal bar or space width.

Transmission Control Protocol/Internet Protocol. See **TCP/IP**.

Trivial File Transfer Protocol. See **TFTP**.

TSR. See **Terminate and Stay Resident**.

U

UDP. User Datagram Protocol. A protocol within the IP protocol suite that is used in place of TCP when a reliable delivery is not required. For example, UDP is used for real-time audio and video traffic where lost packets are simply ignored, because there is no time to retransmit. If UDP is used and a reliable delivery is required, packet sequence checking and error notification must be written into the applications.

UPC. Universal Product Code. A relatively complex numeric symbology. Each character consists of two bars and two spaces, each of which is any of four widths. The standard symbology for retail food packages in the United States.

V

Visible Laser Diode (VLD). A solid state device which produces visible laser light.

W

Warm Boot. A warm boot restarts the mobile computer by closing all running programs. All data that is not saved to flash memory is lost.

Index

Numerics

123Scan parameters	9-1
2D bar codes	
aztec	10-77
aztec inverse	10-78
code 128 emulation	10-72
data matrix	10-73
data matrix inverse	10-74
maxicode	10-75
MicroPDF417	10-71
MicroQR	10-77
PDF417	10-71
QR code	10-75
QR inverse	10-76

A

actions	11-2
ADF	11-1
actions	11-1, 11-27
move cursor	11-31
send data	11-27
setup fields	11-30
alphanumeric keyboard	11-91
alternate rule sets	11-3
bar code list	11-5
bar code menu example	11-2
beep	11-47
code lengths	11-18
code types	11-11
criteria	11-1, 11-11
default rules	11-5
move cursor past a character	11-30
move cursor past string	11-30
move cursor to a character	11-30
move cursor to last occurrence of string and	

replace	11-31
move cursor to start of data	11-30
move cursor to string and replace	11-30
numeric keypad	11-24, 11-25
pad spaces	11-38
pad zeros	11-42
rules	11-1
rules hierarchy	11-4
send alt characters	11-66
send control characters	11-47
send function key	11-76
send keyboard characters	11-52
send keypad characters	11-71
send preset value	11-31
send value	11-36
skip ahead "n" characters	11-31
skip ahead characters	11-33
skip back "n" characters	11-31
skip back characters	11-34
skip cursor to end	11-31
space removal	11-37
special commands	11-8
specific data string	11-22
specific string	
any location	11-23
any message ok	11-23
at start	11-22
rule belongs to set	11-26
search	11-23
turn off rule sets	11-89, 11-90
zero removal	11-37
advanced data formatting	11-1
actions	11-1, 11-27
alphanumeric keyboard	11-91
alternate rule sets	11-3
bar code menu example	11-2
beep	11-47

code lengths	11-18
code types	11-11
criteria	11-1, 11-11
default rules	11-5
numeric keypad	11-24, 11-25
pad spaces	11-38
pad zeros	11-42
rules	11-1
rules hierarchy	11-4
send alt characters	11-66
send control characters	11-47
send function key	11-76
send keyboard characters	11-52
send keypad characters	11-71
send preset value	11-36
setup fields	11-30
skip ahead characters	11-33
skip back characters	11-34
space removal	11-37
special commands	11-8
specific data string	11-22
turn off rule sets	11-89, 11-90
zero removal	11-37
aiming options	
decoding aiming pattern	4-13
snapshot aiming pattern	5-10
snapshot mode timeout	5-10
video view finder	5-23
aiming pattern	2-5, 5-10
enabling	4-13
orientation	2-5, 2-6
aiming tips	2-6
ASCII values	
RS-232	8-19
USB	7-13
autoexposure	5-6

B

bar codes

matrix 2 of 5 check digit	10-57
123Scan	9-1
abort macro PDF entry	10-83
ADF list	11-5
Australian postal	10-63
autoexposure	5-6
aztec	10-77
aztec inverse	10-78
beep after good decode	4-11
beeper tone	4-5
beeper volume	4-6
bits per pixel	5-18, 5-21
bookland EAN	10-9

bookland ISBN	10-21
buffering	10-33
cancel	D-2
Chinese 2 of 5	10-54
codabar	10-48
codabar CLSI editing	10-50
codabar lengths	10-48, 10-49
codabar NOTIS editing	10-50
code 11	10-38
code 11 lengths	10-38, 10-39
code 128	10-23, 10-25
code 128 emulation	10-72
code 128 lengths	10-23
code 39	10-28
transmit buffer	10-34
code 39 check digit verification	10-31
code 39 full ASCII	10-32
code 39 lengths	10-30
code 39 transmit check digit	10-32
code 93	10-36
code 93 lengths	10-36, 10-37
composite CC-A/B	10-67
composite CC-C	10-67
composite TLC-39	10-68
convert UPC-E to UPC-A	10-19
convert UPC-E1 to UPC-A	10-19
crop to address	5-12
data matrix	10-73
data matrix inverse	10-74
data options	4-15
pause duration	11-8
prefix/suffix values	4-16
transmit code ID character	4-15
decode aiming pattern	4-13
decode mirror images	4-14
decode session timeout	4-10
digital imager scanner	
default table	5-2
discrete 2 of 5	10-46
lengths	10-47
discrete 2 of 5 lengths	10-46
DP illumination	4-12
EAN zero extend	10-20
EAN-13/JAN-13	10-9
EAN-8/JAN-8	10-8
event reporting	
boot up event	6-15
decode event	6-14
parameter event	6-15
fixed exposure	5-8
fixed gain	5-8
flush macro buffer	10-83
fuzzy 1D processing	4-13
GS1 DataBar	10-65

- GS1-128 10-25
- I 2 of 5 check digit verification 10-44
- I 2 of 5 convert to EAN-13 10-45
- I 2 of 5 transmit check digit 10-44
- illumination 4-11, 5-6
- illumination bank control 5-7
- image brightness (target white) 5-14
- image cropping 5-11
- image enhancement 5-16
- image file format 5-17, 5-20
- image resolution 5-13
- intercharacter gap size 10-82
- interleaved 2 of 5 10-42
 - convert to EAN-13 10-45
 - lengths 10-42, 10-43
- inverse 1D 10-59
- ISSN EAN 10-22
- Japan postal 10-62
- JPEG image options 5-14
- JPEG quality and size 5-15
- JPEG target file size 5-15
- low exposure priority for snapshot mode 5-9
- low gain priority for snapshot mode 5-9
- low light enhancement 5-5
- matrix 2 of 5 10-55
- matrix 2 of 5 lengths 10-56
- matrix 2 of 5 redundancy 10-57
- maxicode 10-75
- MicroPDF417 10-71
- MicroQR 10-77
- miscellaneous
 - scan data options 4-17
 - transmit no read msg 4-19
- MSI 10-51
- MSI check digit algorithm 10-53
- MSI check digits 10-52
- MSI lengths 10-51, 10-52
- MSI transmit check digit 10-53
- Netherlands KIX code 10-63
- numeric bar codes D-2
- parameter scanning 4-5
- PDF417 10-71
- picklist modes 4-9
- postal 10-60
- prefix/suffix values 4-16
- presentation mode field of view 5-5
- QR code 10-75
- QR inverse 10-76
- redundancy level 10-79
- report version 10-82
- RS-232
 - baud rate 8-7
 - beep on bel 8-16
 - check receive errors 8-11
 - data bits 8-10
 - default table 8-3
 - hardware handshaking 8-11, 8-12, 8-13
 - host serial response time-out 8-15
 - host types 8-6
 - intercharacter delay 8-17
 - parity 8-9
 - RTS line state 8-16
 - software handshaking 8-13, 8-14
 - stop bit select 8-16
- samples C-1
- security level 10-81
- set defaults 4-4
- signature capture 5-19
- signature capture height 5-22
- signature capture JPEG quality 5-22
- signature capture width 5-22
- snapshot aiming pattern 5-10
- snapshot mode timeout 5-10
- SSI
 - baud rate 6-4
 - check parity 6-7
 - data packet format 6-8
 - default table 6-3
 - host character timeout 6-11
 - host RTS line state 6-8
 - host serial response time-out 6-10
 - interpacket delay 6-13
 - multipacket option 6-12
 - parity 6-6
 - software handshaking 6-7
 - stop bit select 6-9
- supplementals 10-10
- symbolologies
 - default table 10-2
 - ISBT concatenation 10-26, 10-27
 - ISBT concatenation redundancy 10-27
 - Netherlands KIX code 10-63
- transmit matrix 2 of 5 check digit 10-58
- transmit UK postal check digit 10-62
- transmit US postal check digit 10-61
- trigger modes 4-8
- UCC coupon extended code 10-22
- UK postal 10-61
- UPC composite mode 10-69
- UPC/EAN
 - coupon code 10-22
 - supp redundancy 10-14
- UPC/EAN/JAN
 - supplemental redundancy 10-14
- UPC-A 10-7
- UPC-A preamble 10-16
- UPC-A/E/E1 check digit 10-14, 10-15
- UPC-E 10-7

- UPC-E preamble 10-17
- UPC-E1 10-8
- UPU FICS postal 10-64
- US planet 10-60
- US postnet 10-60
- USB
 - caps lock override 7-8
 - country keyboard types 7-6
 - default table 7-3
 - device type 7-4
 - keystroke delay 7-8
 - SNAPI handshaking 7-5
 - unknown characters 7-9
- USPS 4CB/One Code/Intelligent Mail 10-64
- video frame size 5-23
- video image size 5-24
- video view finder 5-23
- beeper definitions 2-2
- bullets xvi

C

- cables
 - installing 1-3
 - interface 1-4
 - removing cables 1-3
 - signal descriptions 3-8
- character sets
 - RS-232 8-19
 - USB 7-13
- Chinese 2 of 5 bar codes 10-54
- codabar bar codes
 - CLSI editing 10-50
 - codabar 10-48
 - lengths 10-48, 10-49
 - NOTIS editing 10-50
- code 11 bar codes
 - code 11 10-38
 - lengths 10-38, 10-39
- code 128 bar codes
 - code 128 10-23, 10-25
 - GS1-128 10-25
 - ISBT concatenation 10-26, 10-27
 - ISBT concatenation redundancy 10-27
 - lengths 10-23
- code 128 emulation bar codes 10-72
- code 39 bar codes
 - buffering 10-33
 - check digit verification 10-31
 - code 39 10-28
 - full ASCII 10-32
 - lengths 10-30
 - transmit check digit 10-32
- code 93 bar codes

- code 93 10-36
- lengths 10-36, 10-37
- code identifiers
 - AIM code IDs B-3
 - modifier characters B-4
 - Symbol B-1
- code types
 - ADF 11-11
- composite bar codes
 - composite CC-A/B 10-67
 - composite CC-C 10-67
 - composite TLC-39 10-68
 - UPC composite mode 10-69
- configurations, scanner xv
- connecting
 - interface cable 1-3
 - power 1-4
 - RS-232 interface 8-2
 - USB interface 7-2
- conventions
 - notational xvi
- cropping 5-11, 5-12

D

- data matrix bar codes 10-73
- DataBar 10-65
- decode zones
 - direct part mark 2-12, 2-13
 - document capture 2-10, 2-11
 - high density 2-14, 2-15
 - standard range 2-8, 2-9
- default parameters
 - imaging preferences 5-2
 - RS-232 8-3
 - SSI 6-3
 - standard default table A-1
 - symbolologies 10-2
 - USB 7-3
 - user preferences 4-2
- digital imager scanner
 - defaults 5-2
 - parts 2-1
- discrete 2 of 5 bar codes
 - discrete 2 of 5 10-46
 - lengths 10-46

E

- exposure options
 - autoexposure 5-6
 - fixed exposure 5-8
 - fixed gain 5-8
 - gain / exposure priority for snapshot mode 5-9

- illumination 4-11, 5-6
 - low light enhancement 5-5
 - presentation mode field of view 5-5
- F**
- fixed exposure 5-8
 - fixed gain 5-8
- G**
- gain / exposure priority for snapshot mode 5-9
 - GS1 DataBar 10-65
 - Convert GS1 DataBar to UPC/EAN 10-66
- H**
- host types
 - RS-232 8-6
- I**
- illumination 4-11, 5-6
 - bank control 5-7
 - DP 4-12
 - image brightness (target white) 5-14
 - image cropping 5-11, 5-12
 - image enhancement 5-16
 - image options
 - bits per pixel 5-18
 - cropping 5-11, 5-12
 - file formats 5-17, 5-20
 - image brightness (target white) 5-14
 - image enhancement 5-16
 - image resolution 5-13
 - JPEG image options 5-14
 - JPEG size/quality 5-15
 - JPEG target file size 5-15
 - image resolution 5-13
 - imaging preferences parameters 5-2
 - intellistand 2-7
 - interleaved 2 of 5 bar codes
 - check digit verification 10-44
 - convert to EAN-13 10-45
 - transmit check digit 10-44
- J**
- JPEG image options 5-14
 - size/quality 5-15
 - JPEG target file size 5-15
- L**
- LED definitions 2-4
 - low light enhancement 5-5
- M**
- macro PDF 10-83
 - macro PDF bar codes
 - abort macro PDF entry 10-83
 - flush buffer 10-83
 - maintenance 3-1
 - matrix 2 of 5 bar codes 10-55
 - check digit 10-57
 - lengths 10-56
 - redundancy 10-57
 - transmit check digit 10-58
 - maxicode bar codes 10-75
 - MicroPDF417 bar codes 10-71
 - Motorola enterprise mobility support xvii
 - mounting
 - desk mount 1-4
 - intellistand 2-7
 - wall mount 1-5
 - MSI bar codes
 - check digit algorithm 10-53
 - check digits 10-52
 - lengths 10-51, 10-52
 - MSI 10-51
 - transmit check digit 10-53
- N**
- notational conventions xvi
- P**
- parts 2-1
 - PDF417 bar codes 10-71
 - pinouts
 - scanner signal descriptions 3-8
 - postal codes 10-60
 - Australian postal 10-63
 - Japan postal 10-62
 - Netherlands KIX code 10-63
 - transmit UK postal check digit 10-62
 - transmit US postal check digit 10-61
 - UK postal 10-61
 - UPU FICS postal 10-64
 - US planet 10-60
 - US postnet 10-60
 - USPS 4CB/One Code/Intelligent Mail 10-64
 - power connection 1-4
 - presentation mode field of view 5-5

Q

QR code bar codes 10-75

R

RS-232
 connection 8-2
 default parameters 8-3
 parameters 8-4, 8-6

S

sample bar codes C-1
 scanning
 errors 4-2, 5-2, 10-2
 hand-held 2-4
 presentation mode 2-7
 sequence example 4-2, 5-2, 10-1
 service information xvii
 setup
 connecting a USB interface 7-2
 connecting an RS-232 interface 8-2
 connecting power 1-4
 connecting using SSI 6-2
 installing the cable 1-3
 unpacking 1-2
 signal descriptions 3-8
 signature capture 5-19
 bits per pixel 5-21
 file format selector 5-20
 height 5-22
 JPEG quality 5-22
 width 5-22
 snapshot mode timeout 5-10
 specifications 3-4
 SSI connection 6-2
 SSI default parameters 6-3
 standard default parameters A-1
 support xvii
 symbology default parameters 10-2

T

technical specifications 3-4
 troubleshooting 3-2

U

unpacking 1-2
 UPC/EAN bar codes
 bookland EAN 10-9
 bookland ISBN 10-21
 check digit 10-14, 10-15

convert UPC-E to UPC-A 10-19
 convert UPC-E1 to UPC-A 10-19
 EAN zero extend 10-20
 EAN-13/JAN-13 10-9
 EAN-8/JAN-8 10-8
 ISSN EAN 10-22
 supplementals 10-10
 UCC coupon extended code 10-22
 UPC-A 10-7
 UPC-A preamble 10-16
 UPC-E 10-7
 UPC-E preamble 10-17
 UPC-E1 10-8

USB

 connection 7-2
 default parameters 7-3
 parameters 7-4
 user preferences parameters 4-2

V

video view finder 5-23
 frame size 5-23
 image size 5-24

W

wall mounting 1-5

Tell Us What You Think...

We'd like to know what you think about this Manual. Please take a moment to fill out this questionnaire and fax this form to: (631) 738-4913, or mail to:

Motorola, Inc.
One Motorola Plaza M/S B-10
Holtsville, NY 11742-1300
Attention: Advanced Data Capture
Technical Publications Manager



important If you need product support, please call the appropriate customer support number provided. Unfortunately, we cannot provide customer support at the fax number above.

Manual Title: _____

(please include revision level)

How familiar were you with this product before using this manual?

- Very familiar Slightly familiar Not at all familiar

Did this manual meet your needs? If not, please explain.

What topics need to be added to the index, if applicable?

What topics do you feel need to be better discussed? Please be specific.

What can we do to further improve our manuals?



MOTOROLA

Motorola, Inc.
One Motorola Plaza
Holtsville, New York 11742, USA
1-800-927-9626
<http://www.motorola.com/enterprisemobility>

MOTOROLA and the Stylized M Logo and Symbol and the Symbol logo are registered in the U.S. Patent and Trademark Office.
All other product or service names are the property of their respective owners.
© Motorola, Inc. 20089



72E-83978-06 Revision A - May 2009