

Thermal Receipt Printer Operating Manual

VTP-80

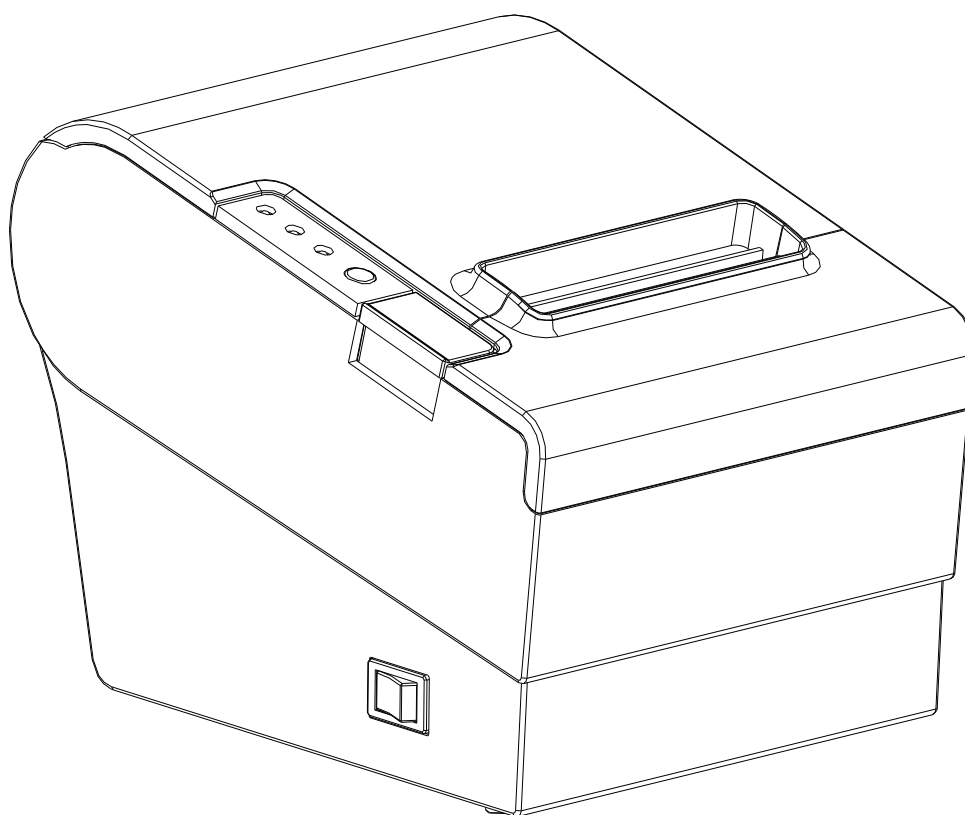















Use only approved consumables.

Any problems or faults caused by the use of similar products will void the warranty.

Safety Warning:

In order to operate our printer correctly and prevent any danger or damage, please be sure to follow instructions while operating our products:

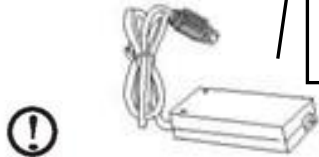
 <p>Warning</p> <p>Infringing the instructions below may cause severe injury or death.</p>	
<p>Do not simultaneously connect power plugs of different products on one power bar.</p> <ul style="list-style-type: none"> ● May cause heat or fire. Dangerous ● Once the power plug is stained with foreign body or water, please use it after cleaning. ● When the ports of power socket is loose, please don't plug in. ● Use standard products for multiple ports socket. <p>Forbiddance </p> 	<p>When detected suspicious smells, smokes or sound, please shut off the power at once and then take the following measures:</p> <ol style="list-style-type: none"> 1. Be sure to unplug the power from the socket. 2. Confirming no smoke and then get help from the purchase place for processing warranty. <p>Forbiddance </p> 
<p>Do not pull the power soft wire when unplugging.</p> <ul style="list-style-type: none"> ● Pulling may crack the soft wire and cause fire or faults. <p>Forbiddance </p> 	<p>Do not plug in or pull out plug with wet hands.</p> <ul style="list-style-type: none"> ● Danger of electric shock <p>Forbiddance </p> 
<p>Keep the drying agent out of the reach of children.</p> <ul style="list-style-type: none"> ● Children may be poisoned if intake the drying agent. <p>Forbiddance </p> 	<p>Keep the poly bag out of reach of children.</p> <ul style="list-style-type: none"> ● Children may be suffocated if misplaced the poly bag on their head. <p>Forbiddance </p> 
<p>Do not overly bend or place heavy load on the power soft wire as it may cause fire.</p> <p>Forbiddance </p> 	<p>Use only supplied products for adaptor.</p> <ul style="list-style-type: none"> ● It is dangerous to use other adaptors. <p>Use only supplied adaptors.</p> 



Warning

Infringing the instructions below may cause severe injury or death.

Do not take apart, repair or transform the products.

- Use only approved accessories or it may cause damage. Please consult with the place of purchase.

Forbiddance



Don't touch the thermal head with hand.

- That may cause burn or influence of printing quality.

Thermal head

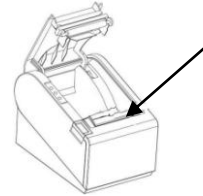

Forbiddance

Do not let water or foreign object get inside the printer.

- If happens, switch off the printer, unplug the power and then contact the place of purchase.

Forbiddance



Place the product on a stable place

- Falling may make breakage and cause injury.

Forbiddance



Do not operate the printer when it breaks down, as it may cause fire or electric shock.

- Close switch power at once, unplug the power and then contact the place of purchase.

Notice

Electronic products such as printers are susceptible to static damage.

To avoid this kind of damage, please power off the printer before connecting or switching off behind cable.

Once static damage happens, please contact the nearest maintenance center.

Product Introduction

VIP-80 printer is compatible with electronic instrument, such as ECR、POS、cash register、receipt bill、computer peripheral equipment etc.

Main Features of the Printer:

- 1.High Speed: 250mm/s.
 - 2.Low noise thermal printing.
 - 3.Support Parallel port,CENTRONIC, and Serial Port (RS_232) .
 - 4.Data buffer built-in (Able to receive printer data while printing) .
 - 5.Equip with circuit driving peripheral to control external device such as cash box.
 - 6.Command support ESC/POS、select different printing density,i.e.adjust dial switch.
 - 7.Support NV bitmap download and printing.
- features NV bitmap download Flash 64kb.
- **Read the manual carefully before usage.

Directory

Chapter 1. Printer Setup and Operation

Contents in the Package.....	05
Connect Cable.....	05
Load and Replace Paper Roll.....	06
Paper Roll Recommendation.....	07
Connect to computer.....	07
Connect to Cash Drawer.....	07
Connect to Power.....	08
Printer Control Panel.....	09
Setting Printer Mode.....	09

Chapter 2. Printer Management

Self-Checking.....	10
Printer Maintenance.....	10
Fix Paper Jam.....	11





Chapter 3. Appendix and Product Specification

Specification.....	12
--------------------	----

Chapter 1. Printer Setup and Operating

Contents in the Package

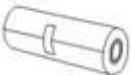
Check below items, Please contact the dealer for any breakdown or absent.

 VTP-80	 Power Adaptor	 Power Cable
 Paper Roll	 CD	 Communication Cable

Note: The packing style above is subject to change without notice. If you have any questions please contact your local dealer.

Connect Cable

VTP-80 printer comes with the USB cable in addition to the selected interface cable upon purchasing.

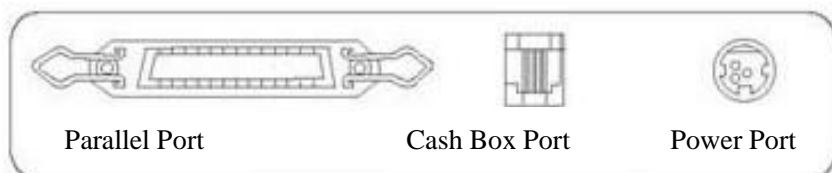

If connecting to ECR, POS or computer is preferred, please use the cable provided in printer or request it from the place of purchase.

Load and Replace Paper Roll

Press the Button to Open Paper Roll Cover

Remove the used paper roll to replace with a new roll

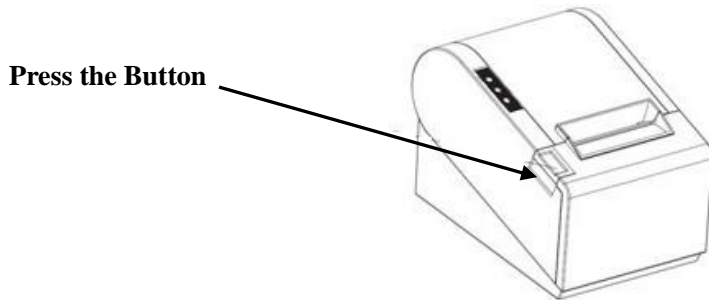

1. Load the paper roll as shown in the image below:

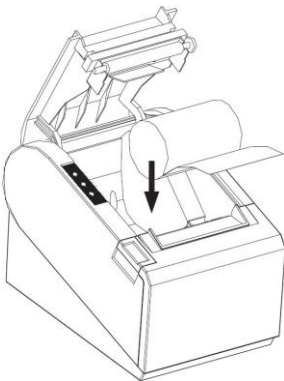

2. Make sure the paper roll is loaded in the correct direction.

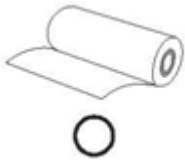

Correct Direction

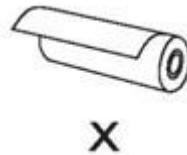

Wrong Direction

3. Pull out the roll paper to the bottom front of the printer and then close the cover as shown in image below.

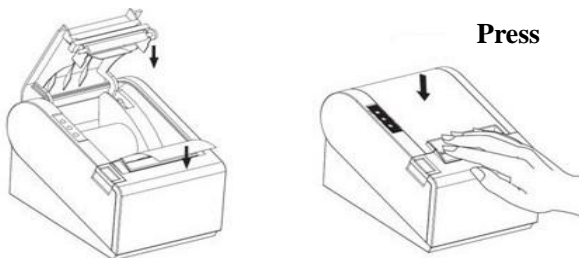

4. Tear off extra paper roll as showed in below image
Use Auto-cutter or cutter point of machine



Paper Roll Recommendation

Paper Roll Specification	Manufacturer
HPK-110	Hansol patech Co.,Ltd
AF50KS-E	JUJO Paper Co.,Ltd
TF-50KS-E	Nippon Paper Industries Co.,Ltd
PD-160R	New Oji Paper Mfg,Co.,Ltd
F380	Kansaki Specialty Papers,Inc.

Improper paper roll may lead to critical fault on printer head and shortened the machine life span. Thus be sure to use the recommended paper roll. Any issue caused by using other branded paper roll will void the warranty, even during the warranty period.

Connect to Computer (PC-POS)

Connect to the provided cable as shown in the image below.

1 Connect the other end of parallel cable to printer port on the computer.

2 Connect the other end of parallel cable to the printer port of computer.

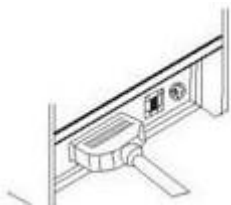

Connect to VTP-80



Connect to Computer

Connect to Cash Drawer

Connect cash drawer cable to cash drawer port which is behind the printer

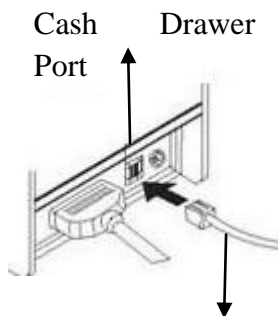

Cash drawer cable connection.

Use 12-24V/1A power supply cash drawer, which is also compatible with printer. The improper cash drawer will cause damage both to the cash drawer and the printer.

Do not connect cash drawer port to the telephone line. It may cause failure condition on telephone line and printer.

Connect to Power

1. Make sure the power is unplugged and the printer is powered off before connecting the power cord.

2. Connect to power

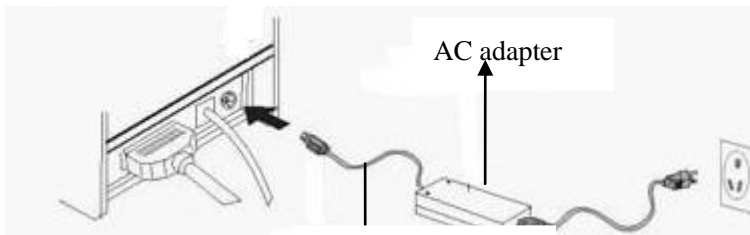

Power Cable

3. Turn on the power switch on the printer side to connect to the power supply.

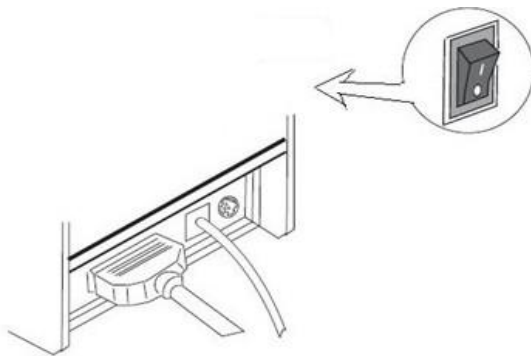

Printer Control Panel

Control Board

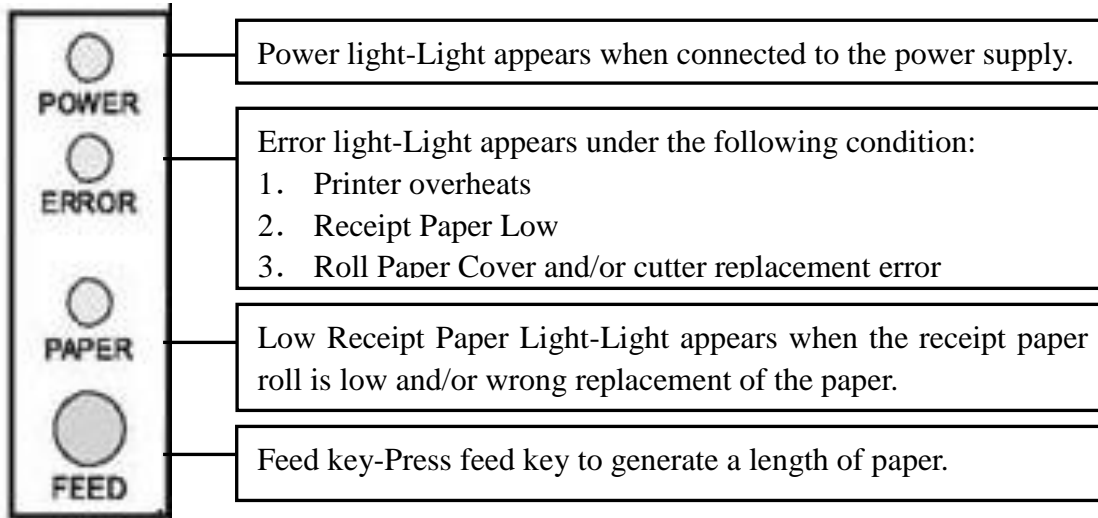

Setting Printer Mode

VTP-80 printer is initially setup with default value. However, the default printer mode can be reconfigured to satisfy customer's needs through the DIP switch, which is located at the bottom of the printer.

The function of DIP switch setting as follows:

Switch	Function	(on)	(off)
1	cutter	No cutter	With cutter
2	Buzzing prompt	Open buzzing prompt	Close buzzing prompt
3	Printing density	High density	Regular density
4	24 bytes mode	No Chinese Character	With Chinese Character
5	Character per line	42	48
6	Select cash box	Open cash box	Close cash box
7-8	Transmission rate (apply for serial interface) (refer to below information)		
Transmission rate (bps) -bytes/s		SW-7	SW-8
38400		ON	ON
115200		OFF	ON
9600		ON	OFF
19200		OFF	OFF

Chapter 2. Printer Management

Self-Checking Function

The Self-Checking Function allows the user to identify if the printer is operating normally. If the printer is detected with failure condition, please contact the distributor.

Self-Checking Process :

- Self-checking Procedure:
 1. Make sure the printer is powered off
 2. Press FEED button and switch on the power supply while the FEED button still pressed.
 3. The Self-Checking list should be printing the printer is brought to power.
- Self-Checking function printers out bytes, part of Chinese character set, command mode, interface type, local printer dial-up switch setting printer setting, ..., etc, sequentially.
- For the printer equip with auto-cutter, the auto-cutter spontaneously cuts the receipt paper immediately after finish printing.
- The printer automatically goes into data receipt mode after finish self-checking process.

Printer Maintenance

Maintaining the printer regularly is a necessary step to sustain the printer quality as the residual paper wool got collected through the thermal slice.

Maintaining the Printer with the following steps:

1. Open the paper roll cover and remove the receipt paper roll if necessary.
2. Use the alcohol swab to clean the thermal slice printer head
3. Slight damp a swab and gentle wipe through the roller and the paperchecking sensor
4. Reload the paper roll into the printer and closed the paper roll cover.

Fix Paper Jam

The error light appears and flashes with warning prompt when paper jam happens.

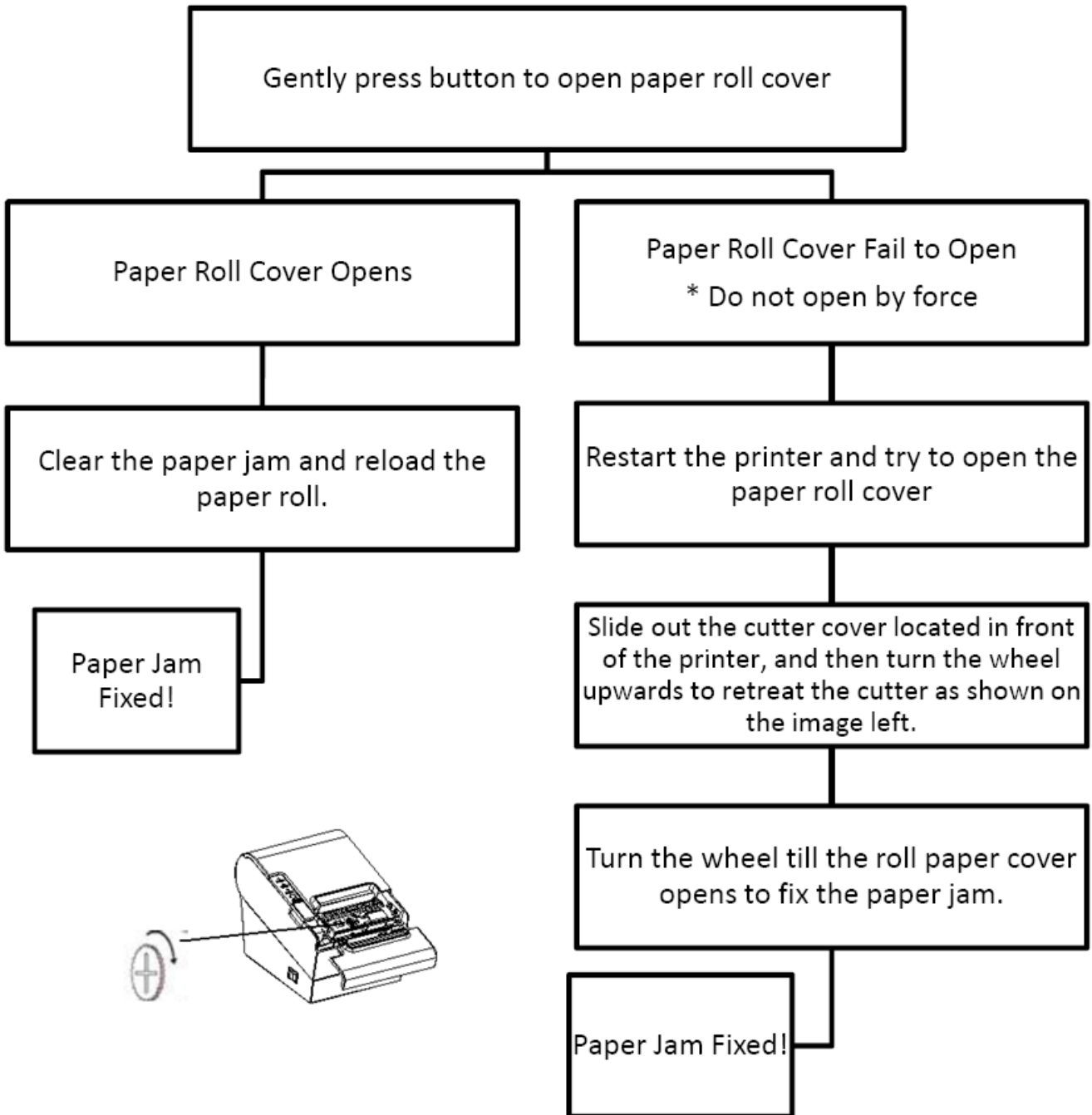

Chapter 3. Appendix and Product Specification

Specification

Printing Property	Printing Method	Thermal Line
	Resolution	203X203dpi(8dots/mm)
	Paper Width	79.5±0.5mm
	Printing Width	72mm
	Printing Character	ASCII Font A: 12X24 ASCII Font A: 9X24 Character 12X24
	Printer Density	512dot/line or 576dot/line
	Printing Speed	250mm/s
	NV bitmap Flash	64kb
	Receipt Buffer	8kb
Note: Printer speed changes as the as the combination of the data transmission speed and control command varies.		
Power Adaptor	Input Voltage	AC 100~240V
	Rate	50/60Hz
	Output Voltage	DC 24V, 2.5A
Environment	Operating Temperature	0~45°C
	Storage Temperature	-10~50°C
	Operating Humidity	10-80%
	Storage Humidity	10-90%
Life Span	Thermal Mechanism	15, 000, 000 lines 10×105 (~ 100km)
	Auto-cutter	1, 000, 000cuts
	MCBF	60, 000, 000 line